



INDUSTRIAL SEWING MACHINE

MODEL

**PLK-J-PAL**

TECHNICAL MANUAL

Operation Panel

<b>[1] For safe use</b> .....	[1]-1
<b>[2] Precautions for use</b> .....	[2]-1
<b>[3] Explanations of basic screen, icons and operation</b> .....	[3]-1
1. Screen configuration.....	[3]-1
2. Explanations of Standard screen 1 .....	[3]-2
3. Digital tension.....	[3]-3
4. Explanations of Standard screen 2 .....	[3]-4
5. The Up/Down Counter screen is explained below.....	[3]-5
6. The Bobbin Winding screen is explained below .....	[3]-5
7. Explanations of basic icons .....	[3]-6
8. Explanation of operations .....	[3]-7
9. Adjusting the Liquid Crystal Contrast.....	[3]-8
<b>[4] Sewing Data Compatibility</b> .....	[4]-1
<b>[5] Reading, writing and erasing data</b> .....	[5]-1
1. USB.....	[5]-1
2. Reading.....	[5]-3
3. Writing.....	[5]-7
4. Erasing.....	[5]-9
5. Reading data with shortcut icons (Reading from internal memory) .....	[5]-10
6. Rename the data number .....	[5]-11
<b>[6] Creating stitching data</b> .....	[6]-1
1. Flow of data creation .....	[6]-1
2. Description of arrow input screen .....	[6]-4
3. Description of menu.....	[6]-6
4. Skip jogging.....	[6]-7
<b>[7] Methods of creating sewing data</b> .....	[7]-1
1. Linear input.....	[7]-1
2. Arc input.....	[7]-4
3. Circle input .....	[7]-8
4. Curve input.....	[7]-11
5. Broken line input.....	[7]-15
6. Point input .....	[7]-18
7. Code data input .....	[7]-20
8. Back tacking (start/end back tacking) .....	[7]-26
9. Back tacking (overlap back tacking) .....	[7]-28
10. Multiple stitching .....	[7]-30
11. Offset stitching (with overlap back tacking) .....	[7]-33
12. Zigzag stitching (with overlap back tacking).....	[7]-35
<b>[8] Controlling the Presser Foot</b> .....	[8]-1
<b>[9] Table of stitching type combinations</b> .....	[9]-1
<b>[10] Call-up function</b> .....	[10]-1

**[11] Modification mode** \_\_\_\_\_ [11]-1

1. Main modification mode functions.....	[11]-1
2. Entering the modification mode .....	[11]-2
3. Quitting the modification mode .....	[11]-2
4. Changing the feed data to home position .....	[11]-3
5. Confirming on the image screen.....	[11]-4
6. Modifying the stitching start position .....	[11]-6
7. Deleting a stitch (Deleting the designated No. of stitches) .....	[11]-8
8. Deleting a stitch (Deleting all stitches after the designated position).....	[11]-10
9. Adding a stitch (Adding one stitch) .....	[11]-12
10. Adding a stitch (Adding the same stitch).....	[11]-14
11. Modifying the stitch position (Position of subsequent data fixed) .....	[11]-16
12. Modifying the stitch position (Subsequent data position moved) .....	[11]-18
13. Moving a block (Changing the prior/subsequent data) .....	[11]-20
14. Moving a block (Adding new data to the prior/subsequent data).....	[11]-22
15. Modifying a block 1 (Linear input) .....	[11]-24
16. Modifying a block 2 (Broken line, arc, curve input).....	[11]-27
17. Modifying a block 3 (Zigzag input) .....	[11]-32
18. Modifying a block 4 (Changing the feed data).....	[11]-34
19. Modifying stitch length (Designated distance modification) .....	[11]-39
20. Modifying stitch length (All After designated stitch) .....	[11]-41
21. Modifying the stitching speed (All sections after designated position) .....	[11]-43
22. Modifying the stitching speed (N stitches after designated position) .....	[11]-44
23. Modifying code data (Adding code data).....	[11]-46
24. Modifying code data (Deleting code data).....	[11]-48
25. M3 feed angle width .....	[11]-49
26. Digital tension.....	[11]-51
27. PF holding power.....	[11]-53
28. PF stroke.....	[11]-55
29. PF height.....	[11]-57

**[12] Detecting material thickness (DFTH)** \_\_\_\_\_ [12]-1

**[13] Data conversion mode** \_\_\_\_\_ [13]-1

1. Main data conversion mode functions.....	[13]-1
2. Entering the conversion mode .....	[13]-2
3. Quitting the conversion mode .....	[13]-2
4. Confirming on the image screen (for the conversion mode).....	[13]-2
5. Back tacking (Start/end back tacking).....	[13]-3
6. Back tacking (Overlap back tacking).....	[13]-5
7. Zigzag stitching .....	[13]-7
8. Scaling .....	[13]-9
9. Symmetrical.....	[13]-12
10. Rotation.....	[13]-13
11. Offset.....	[13]-15
12. Multiple.....	[13]-17

**[14] Function mode** \_\_\_\_\_ [14]-1

1. Outline.....	[14]-1
2. Explanation of each function mode .....	[14]-2

**[15] Input/ Output setting mode** \_\_\_\_\_ [15]-1

1. Outline.....	[15]-1
2. Explanation of input/output setting mode .....	[15]-2
3. Input signal setting table .....	[15]-6
4. Output signal setting table .....	[15]-9

**[16] Program mode** \_\_\_\_\_ [16]-1

- 1. Setting methods ..... [16]-1
- 2. "System, setting file write" and "Setting file read" ..... [16]-4

**[17] Easy setting** \_\_\_\_\_ [17]-1

- 1. Sewing setting ..... [17]-1
- 2. Language setting ..... [17]-6
- 3. Adjustment setting of each axis ..... [17]-7

**[18] System change** \_\_\_\_\_ [18]-1

- 1. Control box Install..... [18]-2
- 2. PAL Install ..... [18]-3
- 3. I/F board (MIF) Install ..... [18]-4
- 4. Version information..... [18]-5
- 5. Initialize settings ..... [18]-6

**[19] FF-stitch** \_\_\_\_\_ [19]-1

- 1. Outline..... [20]-1
- 2. Explanations of Standard screen 3 ..... [20]-3
- 3. Operation explanation ..... [20]-4

**[20] Program mode list** \_\_\_\_\_ [20]-1

- 1. Wiper..... [20]-1
- 2. Slow start ..... [20]-1
- 3. Clamp..... [20]-1
- 4. Area limit ..... [20]-4
- 5. Needle position..... [20]-4
- 6. Thread breaking sensor..... [20]-5
- 7. Home position ..... [20]-5
- 8. Halt..... [20]-6
- 9. Counter ..... [20]-7
- 10. Presser foot..... [20]-10
- 11. Bobbin winding ..... [20]-12
- 12. Feed method ..... [20]-12
- 13. Speed..... [20]-14
- 14. Thread trimming/Thread release..... [20]-14
- 15. Step..... [20]-16
- 16. Jog ..... [20]-17
- 17. Feed angle ..... [20]-18
- 18. Communication ..... [20]-19
- 19. Digital tension..... [20]-20
- 20. Oil lubrication..... [20]-21
- 21. Other. .... [20]-21
- 22. Pattern..... [20]-22
- 23. Trace ability ..... [20]-23

**[20] Error / Message display** \_\_\_\_\_ [21]-1

- 1. [E-\*\*\*\*] Error code..... [21]-1
- 2. [M-\*\*\*] Message code..... [21]-7



Thank you for purchasing the Mitsubishi industrial sewing machine PLK-J Series. Please read this technical manual before starting to ensure correct and long-term use.

- \* The contents of this manual may not be reproduced in part or whole.
- \* The contents of this manual are subject to change without notice.
- \* An utmost effort has been made to cover all points of operation in this manual. Contact Mitsubishi if you have any questions regarding the contents.

COPYRIGHT(C)2017-2019 MITSUBISHI ELECTRIC CORPORATION

# [1] For safe use

## ■ For safe use

Always observe the following matters to safely use the Mitsubishi industrial electronic sewing machine PLK-J Series.

### Before starting

Before using this control unit, read all of the technical manuals carefully, and correctly use the unit following the manual. Also read the "Mitsubishi Industrial Sewing Machine Technical Manual <Sewing Machine Head>" for details on the general configuration and sewing machine head.

### Application and purpose

This control unit is designed to drive and control the Mitsubishi industrial electronic sewing machine PLK-J Series. Do not use this control unit for other applications or purposes. Do not use this control unit until it has been confirmed that safety measures have been accurately taken for the installed electronic sewing machine head section.

### Working environment

Please use this control unit in the industrial setting only. And do not use this control unit in the following type of environment.

#### (1) Power voltage

- Where the voltage fluctuation exceeds  $\pm 10\%$  of the rated voltage.
- Where the specified power capacity (refer to technical manual [Control unit] page [4]-2 "5. Power capacity") cannot be ensured.

#### (2) Magnetic noise

- Where strong fields or magnetic fields are generated, such as near a high-output high frequency oscillating machine or high frequency welder.

#### (3) Temperature and humidity

- Please use the ambient temperature in more than  $5^{\circ}\text{C}$  and  $35^{\circ}\text{C}$  or less.  
If it is used outside the above ambient temperature, the sewing machine will detect temperature abnormality and protection of the sewing machine may be applied so that operation can not be performed.
- Where the unit will be subject to direct sunlight, or outdoors.
- Near sources of heat, such as heating appliances.
- Where the relative humidity is 45% or less, or 85% or more, and where dew may condense.

#### (4) Atmosphere

- In an atmosphere containing dust or corrosive gases, etc.
- In a flammable gas or explosive environment.

#### (5) Vibration

- If excessive vibration could occur when installed on the sewing machine, separately install the control box.

## ■ Installation

### Control box

Correctly install according to technical manual [Control unit]

### Accessories

Always disconnect the control unit from the main power supply before installing the accessories listed in technical manual [Control unit]. (Turn the power switch OFF, and disconnect the plug from the socket "power supply line".)

### Cable

- (1) Lay the connection cables so that excessive force will not be applied during operation. Do not excessively bend the cables.
- (2) Cables laid near operating machine sections must be separated by at least 25mm.
- (3) Before connecting the power cable to the control box, confirm that the power voltage matches the specifications given on the control box's rating nameplate and factory shipment voltage nameplate. Connect the cable to the indicated positions, and then supply the power. When using a power unit, connect the cable to the power unit and supply the power. In addition, when using a power unit, confirm that the power voltage matches the specifications given on the power unit's rating nameplate. Turn the power switch OFF before making any connections.

### Grounding

**Always ground the power cord's grounding wire.**

### Enclosed units and accessories

Connect the electrical enclosed units and accessories only to the positions indicated in the manual.

## Removal

- (1) Always turn the power switch OFF and disconnect the plug from the socket (power supply line) before removing the control box.
- (2) Do not pull out the cord when disconnecting the plug. Always hold the plug receptacle when disconnecting the plug.
- (3) Note that a high voltage is applied inside the control panel, **so always turn the power OFF and wait at least ten minutes before opening the control box cover.**

## ■ NOTICE CONCERNING CE MARKING

- (1) Electronic sewing machine PLK-J series are applied to CE conformity marking by installing the exclusive device [PLK-J-CE] and [PLK-J-ACR].  
When the products are used in the EU region, these devices are necessary to be installed.
- (2) Electronic sewing machine should be use limited to the industrial areas even though above-mentioned countermeasure is done.  
[Warning] Use in residential areas may cause interference.

## ■ Maintenance, inspection and repairs



- (1) Follow this manual when carrying out maintenance or inspections related to this control unit.
- (2) This unit must be repaired, serviced and inspected only by a worker that has received special training.
- (3) Always turn the power OFF before replacing the needle or bobbin, etc., on the head.
- (4) Use genuine replacement parts for repairs and maintenance.

## ■ Other safety measures





- (1) Keep fingers away from all moving machine parts (especially around the sewing machine needle, etc.).
- (2) Never drop the control unit, or place objects in the clearances.
- (3) Do not operate the sewing machine without the protective parts such as the cover, or protection devices such as the safety breaker.
- (4) If any damage is observed in the control unit, if the unit does not operate correctly, or if the operation is suspicious, always suspend operation. Only operate the machine after the supervisor has adjusted, repaired or inspected the machine.
- (5) The user must not make improvements or changes without instruction from Mitsubishi.

## ■ Caution displays and danger displays

- (1) In this manual, the dangers and danger levels that arise with incorrect handling are classified using the following displays.

 <b>Warning</b>	The warning display shows that incorrect handling can lead to death or serious injuries.
 <b>Caution</b>	The caution display shows that incorrect handling can lead to injuries or damages to your house, household goods, and others.

- (2) The meanings of these symbols are as follows.

	This symbol indicates that the instructions must be followed.		This symbol indicates an electrical hazard or caution (electric shock caution).
	This symbol indicates hot temperature requiring caution.		This symbol indicates that ground wire connection is required.
	This symbol indicates a prohibited action.		

- Always deliver this manual to the end user.
- Store this manual nearby where it can be referred to when necessary.

## [2] Precautions for use

### Warning

1. Do not place foot on the foot switch when turning the power ON.

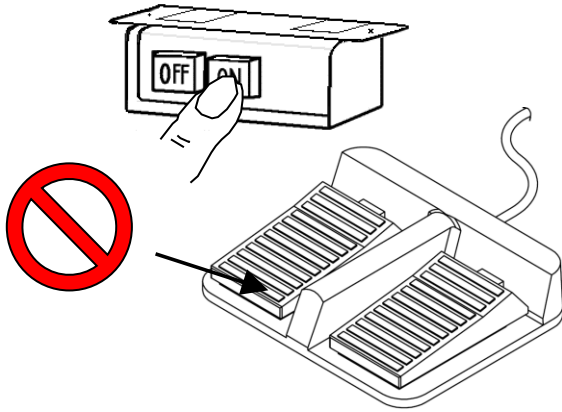

2. Always turn the power OFF when leaving the sewing machine.

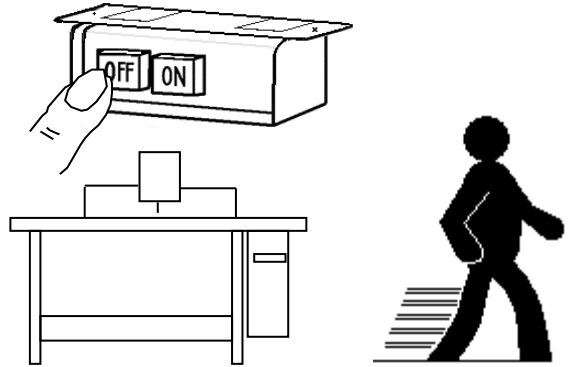

3. Do not inspect the control circuit with a tester.

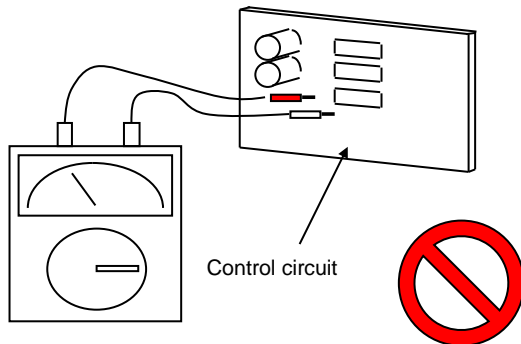

The tester voltage could be applied on the semiconductor parts, and cause damage.

4. Always turn the power switch OFF before tilting the sewing machine head, replacing the needle, or passing thread through the needle.

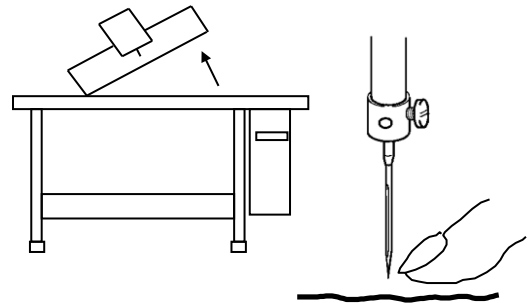

5. Always ground the grounding wire.

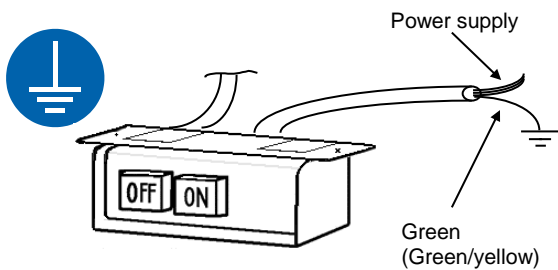

Always ground the provided grounding wire (green (green/yellow)).

6. Do not use excessive wiring.

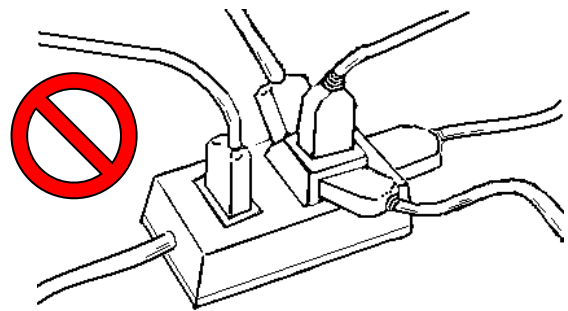

7. A high voltage is applied inside creating a hazardous state, so always turn the power OFF and wait ten minutes before opening the cover.

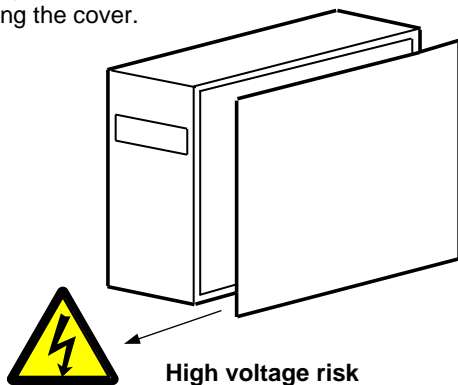

8. Radiation fins and other parts may be hot. Do not touch the parts.

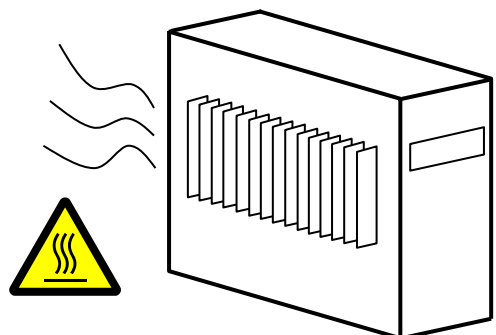

9. The sewing machine will coast to a stop when the power is turned OFF or a power failure occurs during sewing machine operation.
10. Always align the connector shape and direction, and securely insert the connector.
11. If the position detector's connector dislocates, or the sewing machine is completely locked, the motor will be turned OFF automatically for a set time to prevent burning. (Note that the motor may not turn OFF if there is incomplete locking or an overload.) When the fault has been recovered, turn the power OFF and ON once to resume normal operation. The same type of operation will take place if a detector fault or disconnection occurs.

12. Use the machine away from strong noise sources such as high frequency welders.

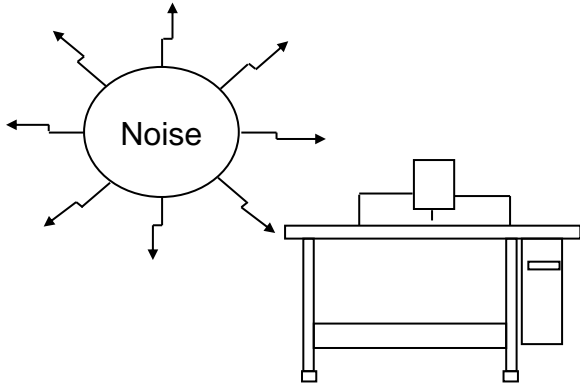

13. When connecting the external switch to an optional connector, etc., keep the signal wire as short as possible. A long wire could cause malfunctions.

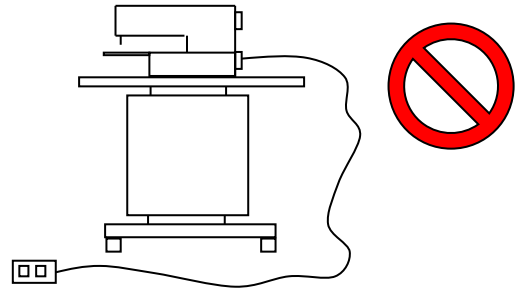

Use a shielded wire for the signal wire when possible.

14. If the fuse blows, remove the cause, and replace the blown fuse with one having the same capacity.

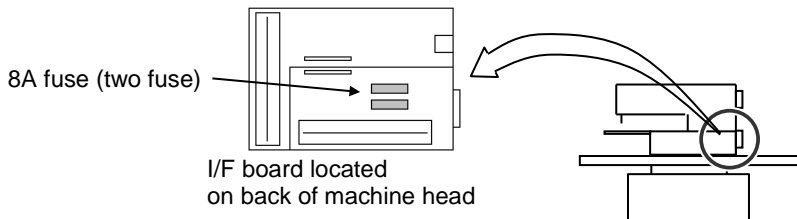
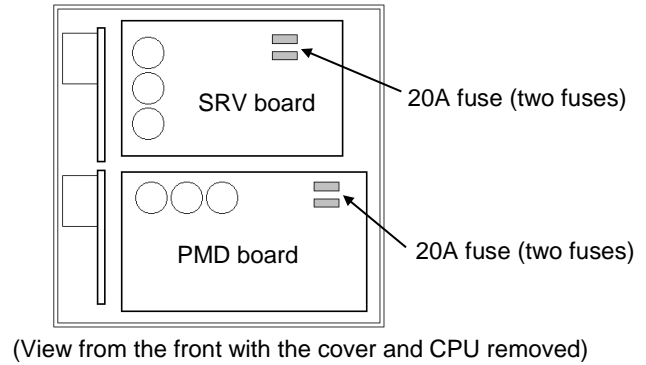
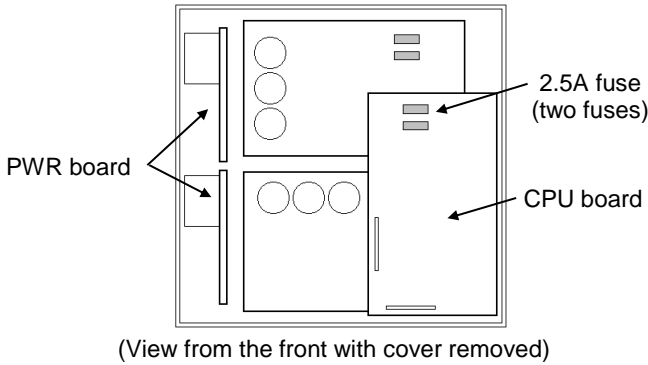

15. Attention when power supply is turned on again

Please make sure not to turn on the power supply switch until after the LED on the front panel of the control box has completely turned off.  
(Please do not turn on the power supply again while displaying the screen of the operation panel.)

‡ If the above operation is not observed, the presser foot (O4 output) may move unexpectedly.

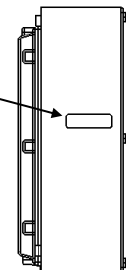

16. When the value of the sewing area limit is changed or the limit setting is deactivated, note the collision and take care safely.  
Also when using it outside the range where the mechanism can be operated, it can not assume the responsibility for all problems caused by it.

# [3] Explanations of basic screen, icons and operation

**Note** When power supply is turned on, if there is not sewing pattern data in the internal memory, the message of [PATTERN DATA DOES NOT EXIST] is displayed.

Press , then the standard screen is displayed.

**Note** When you adjust the contrast to make the operation panel screen easier to view, refer to page [3]-8

## 1. Screen configuration

(1) Standard screen 1.

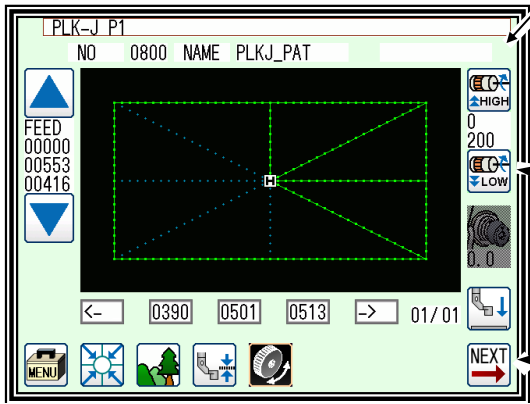

[Line at top of screen]  
Normal: Index  
(simple explanation of screen)  
When any icon is pressed:  
The explanation for that icon will appear.  
(Refer to "sample screen 2".)

Some icons will continue execution while the icon is held down.

Most icons will execute the operation when the finger is released.

(2) While menu icon on Standard screen 1 is held down.

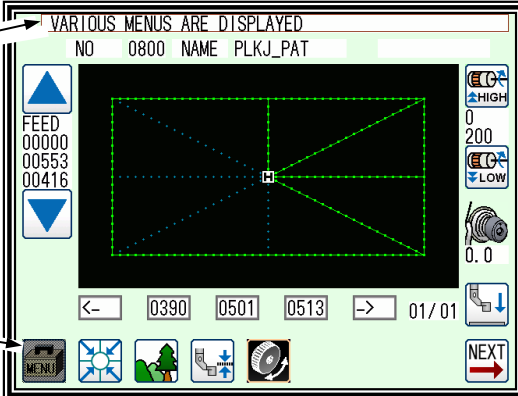

An explanation of the icon and the screen will appear.

This icon (menu icon) is pressed, so the icon will be highlighted.

(3) When menu is opened on Standard screen 1.

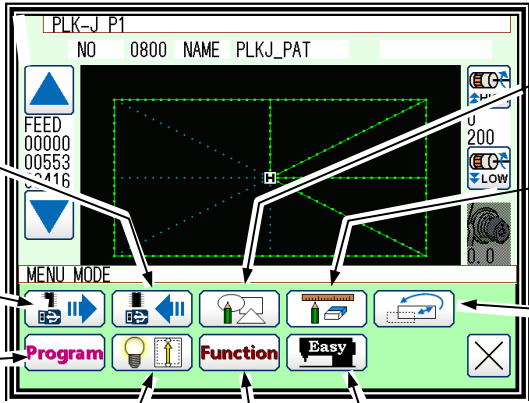

Writing data

Reading data

Program mode

Input/output setting mode

Methods of creating stitching data

Modification mode

Data conversion mode

Easy setting

Function mode

## 2. Explanations of Standard screen 1

The Standard screen 1 is explained in detail below.

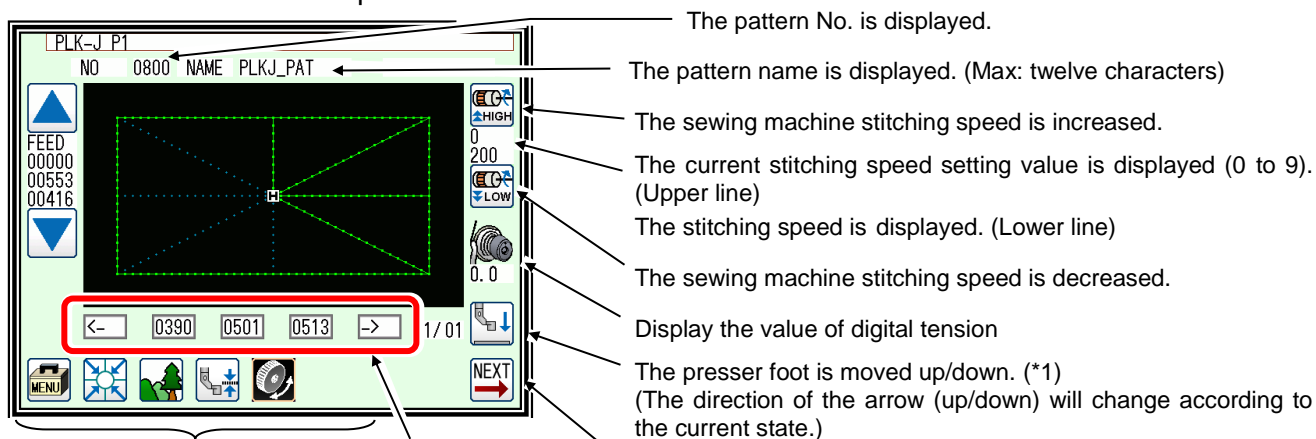

The stitching data is changed. (Data in internal memory)

Standard screen 2 opens.



... Home position return will be executed. (Home position correction is invalid)



... Home position return will be executed. (Home position correction is valid)



... The menu window will open.



... The Image screen will open.



... The screen of setting for PF height will open.



... Hand pulley is not rotated. (Excitation of the main motor becomes ON.)



... Hand pulley is rotated. (Excitation of the main motor becomes OFF.)

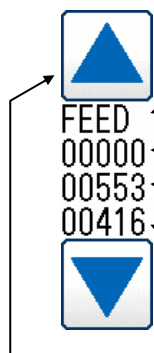

The operation is confirmed. (Jogging in forward/reverse direction)

- (1) If the work holder is lowered after home position return and the forward jogging direction (upward arrow) is pressed, the XY table (work holder) will move according to the stitching data. When the icon is released, the operation will stop at that position. When the jog minus direction (downward arrow) is pressed, the XY table (work holder) will move in the direction that the stitching data returns. When the icon is released, the operation will stop at that position.
- (2) Check pattern data is correct by jogging buttons, before press start pedal.
- (3) During operation, the presser bar lifting will lower at stitching sections in the stitching data, and will rise at the feed data sections.

(\*1) Presser bar lifting: Lowering the presser bar lifting when threading the needle is handy.

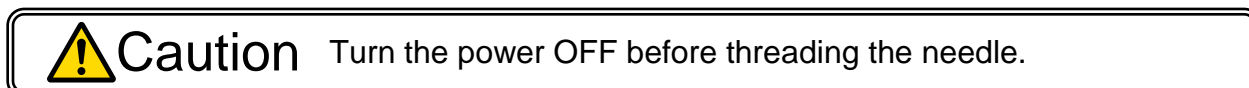



### 3. Digital tension

Digital tension value is displayed.

Digital tension mode is set according to a purpose.

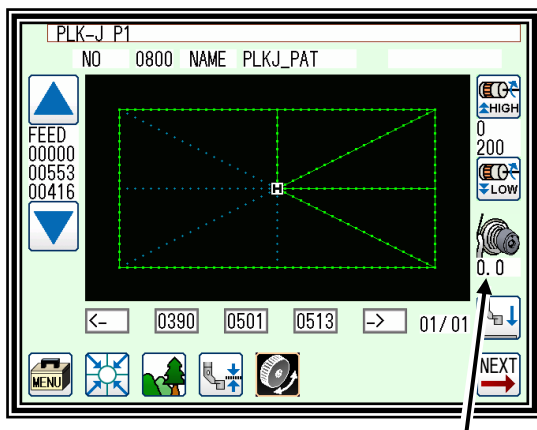

Digital tension gauge. (mode valid)

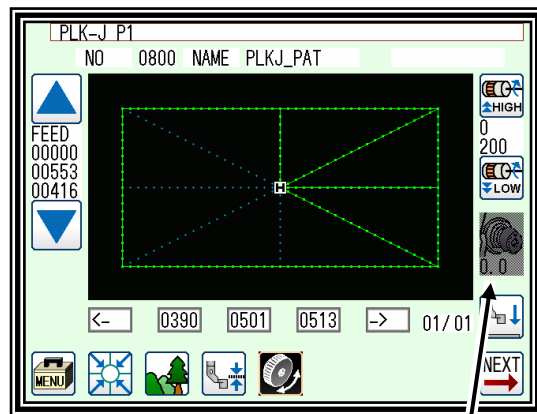

Digital tension gauge. (mode invalid)

Digital tension mode can be selected from the following 4 types. "program mode: DTSN"

OF : Digital tension mode is invalid.

In this mode, the digital tension does not operate in accordance with sewing data and sewing direction.

You can use it by turning the digital tension dial manually, but the numerical value of the digital tension gauge is not displayed. Please use it in the same way as PLK-G.

ME : Digital tension mode is valid.

In this mode, digital tension does not work together with sewing data and sewing direction, but you can remember the position of the digital tension dial. You can check the value of the digital tension gauge by turning the digital tension dial manually. Since the gauge blinks when handling the dial, touch the gauge at the value you want to set and memorize the digital tension dial position. You can automatically return to the position of the dial that you memorized even after the power is turned off, and you can sew at the stored dial position.

**Note** Program mode - By turning on [DTPW] of the sewing pattern, you can activate the dial position of the digital tension saved in sewing data.

PT : Digital tension mode is valid.

In this mode, digital tension works according to sewing data. Patterns read from PLK - G or newly created patterns are created with digital tension code default "DTST". Its value can change the setting value from the program mode.

‡ **You can also enter changes and custom values for other codes in Fix mode.**

An example:

$$\text{DTST} = 80 \text{ "Setting value"} \times 0.5 \text{ "resolution"} = \mathbf{40.0} \text{ "Digital tension gauge value"}$$

(Refer to page [11]-51.)

**Note** You can memorize the position of the digital tension dial in the same way as ME mode,

In this mode, since it operates according to sewing data, the stored position is not used during sewing.

**Note** Program mode - By turning on [DTPW] of the sewing pattern, you can activate the dial position of the digital tension saved in sewing data.

AT : Digital tension mode is valid.

In this mode, the digital tension operates in conjunction with the sewing direction. With the digital tension setting in the simple stitch setting, you can set the ratio of the digital tension value to the eight directions of sewing. It can also be set from the program mode (DTA 0 to DTA 7). Remember the position of the digital tension dial in the same way as in the ME mode.

An example:

$$50 \text{ "Digital tension gauge value"} \times (150\%) \text{ "DAT0"} = \mathbf{75.0} \text{ "Digital tension value in 0 degree direction"}$$

(Refer to page [17]-5.)

## 4. Explanations of Standard screen 2

Displays the Standard screen 2 from the Standard screen 1, by pressing .

The Standard screen 2 is explained in detail below.

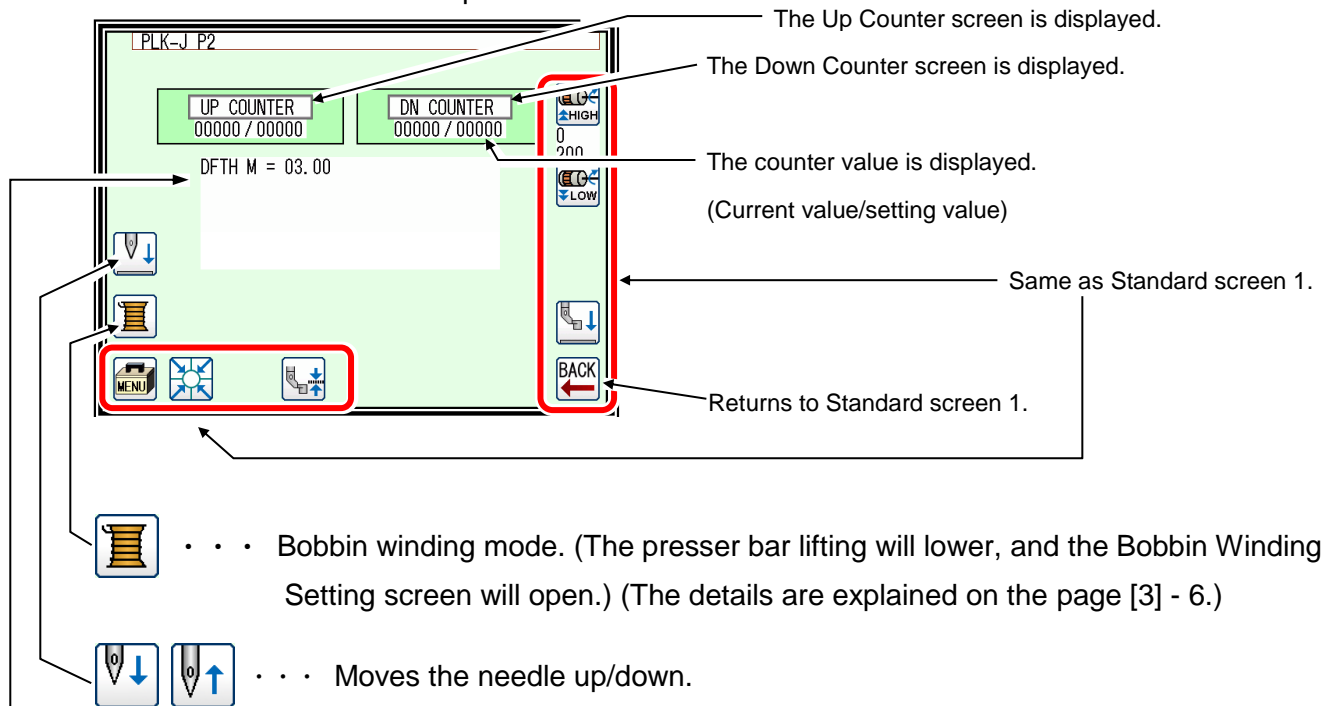

**MULTI INFORMATION WINDOW** : The measured value of DFTH code and stitch abnormality detection is displayed. (Refer to “section [12]”.or page [20] - 23 “23.Trace ability”)

### MULTI INFORMATION WINDOW

(Press NEXT from standard screen 1 to move the screen.)

The result of the thickness detection is displayed on the multi information window of standard screen 2.

DFTH M = measured value OK/NG

DFTH M = BASE (reference point)

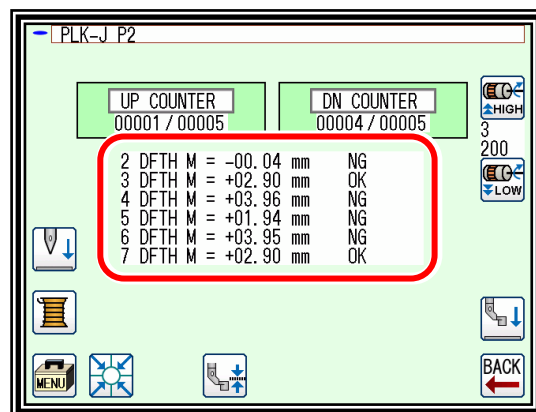

The result of stitch abnormality detection is displayed on the multi information window of standard screen 2.

SKCF P = Stitch point where suspected abnormal stitch was detected.

SKCF C = Number of times where suspicion of abnormal stitch was detected.

S2CF P = Stitch point where suspected abnormal stitch 2 was detected.

S2CF C = Number of times where suspicion of abnormal stitch 2 was detected.

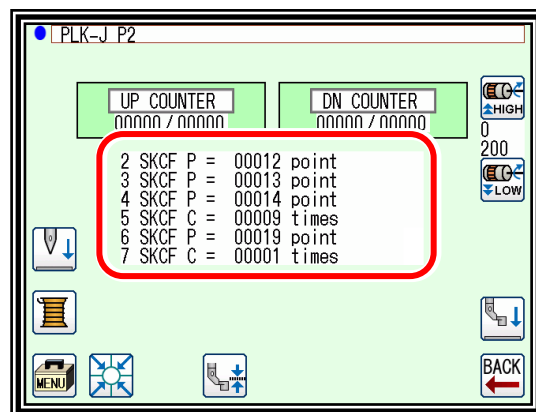

**Note** By setting, you can also clear the multi information display at the start of sewing. (Refer to program mode page [20] - 21 “21.Other” CMIF.)

- Note** For FF-stitch compatible models, you can move to standard screen 3 from the figure below  
 For "FF-stitch", refer to "[19] FF-stitch".  
 ‡ For compatible models, please contact the dealer.

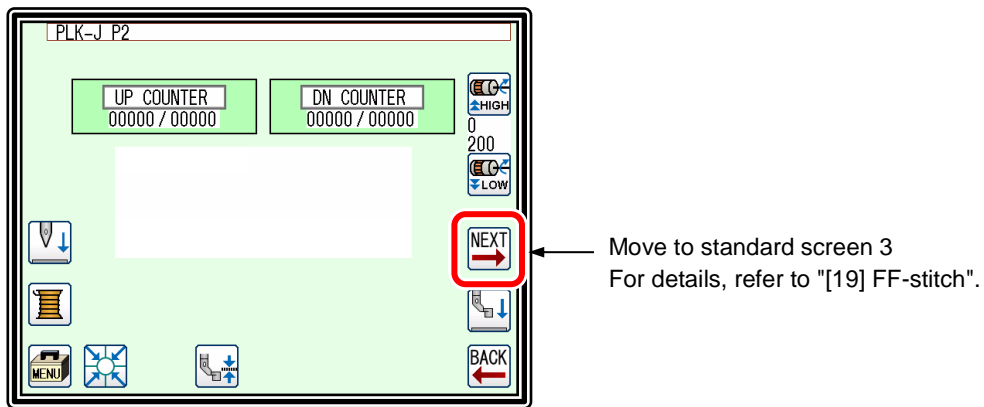

## 5. The Up/Down Counter screen is explained below

(The Down Counter screen is the same, except for the valid/invalid icon design.)

- ‡ The methods of counting with the up counter (down counter) and clearing the counter are determined by The program mode setting. (page [20] - 7)

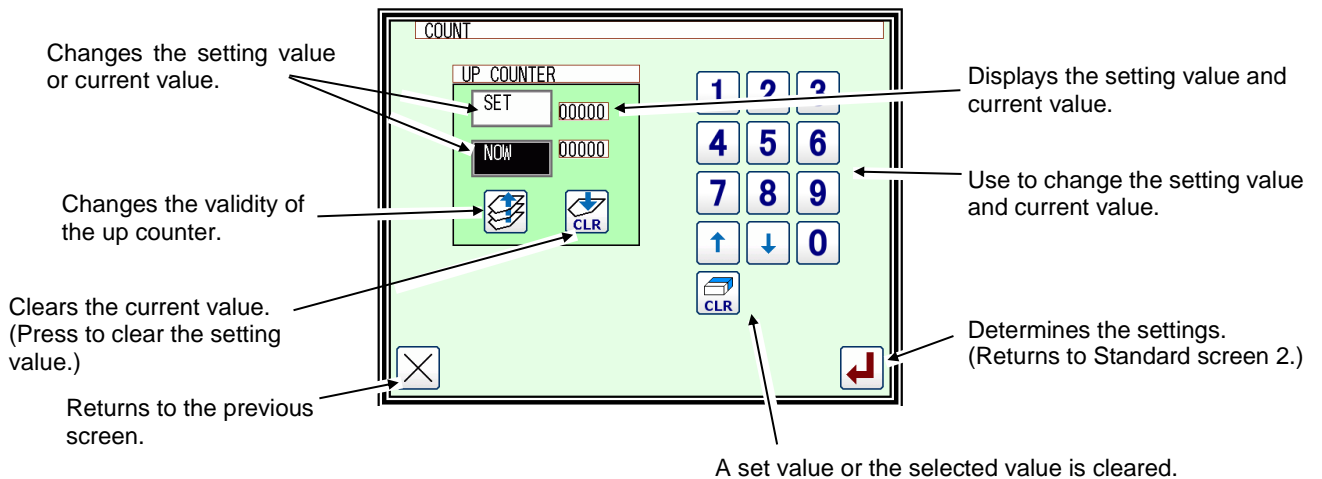

- ‡ When this screen is displayed, sewing cannot be performed.

## 6. The Bobbin Winding screen is explained below

This screen is used to wind thread on the bobbin. (The presser bar lifting will lower when the bobbin winding icon is pressed on the Standard screen 2.)

When the work holder switch is turned ON and the start switch is turned ON, the sewing machine will start rotating at the set speed. The XY table will not move at this time. The sewing machine will stop at the needle UP position when the start switch is turned OFF.

‡ The bobbin winding operation is determined by the program mode setting. (page [20]-12)

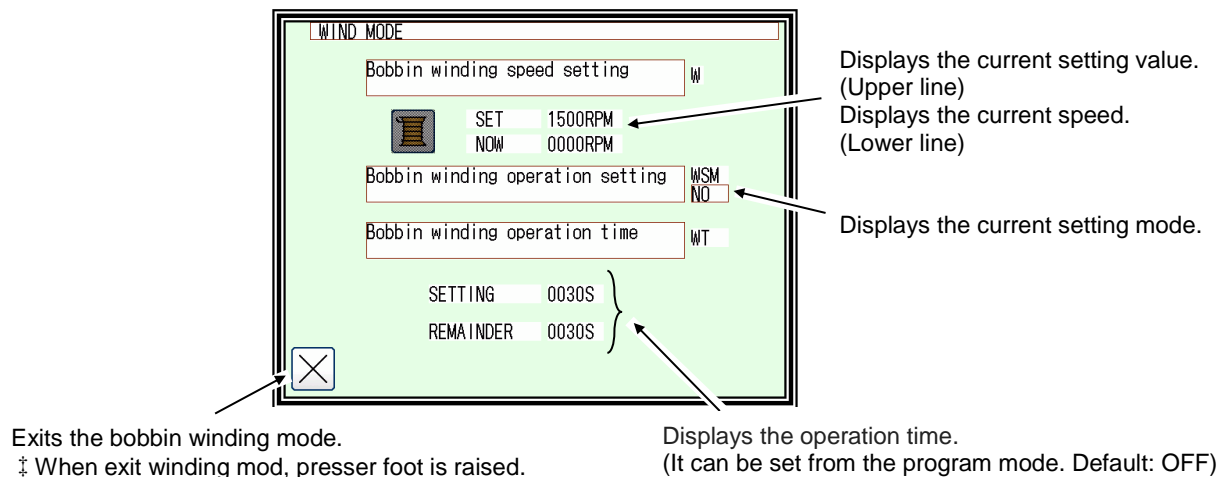

## 7. Explanations of basic icons

The basic icons used commonly on several screens are explained in this section.



... Executes home position return.



... Enter : determines the settings, etc.



... Returns to the previous screen.



... Exits the current mode.



... Cancel : undo the previous operation.



... Opens the menu window.



... Displays the previous/next list when lists are displayed.

(pattern data list, mode list, etc.)



... Turns skip jogging ON/OFF, and opens the operation setting screens.



... Move the presser foot up and down.



... Go to the next page.



... Back to previous page.

## 8. Explanation of operations

### (1) Stitching operations.

[1] Reconfirm the stitching data before starting. Take special care to the set stitching speed.

[2] The stitching speed is determined according to the set speed and stitch length. The maximum stitching speed is determined by the speed setting, and the stitch length limits the stitching speed.

**⚠ [Caution] Do not change the sewing machine stitching speed during operation except in emergencies. (Changing the speed can cause fault such as thread catching faults.)**

[3] Set the material to be stitched, and turn the work holder switch ON. Next, when the start switch is turned ON, the sewing machine will start rotating and stitching. Once started, stitching will continue even the operator's foot is released from the start switch. When the stitching is completed, and the work holder returns to the home position, the sewing machine will stop and the work holder will automatically rise.

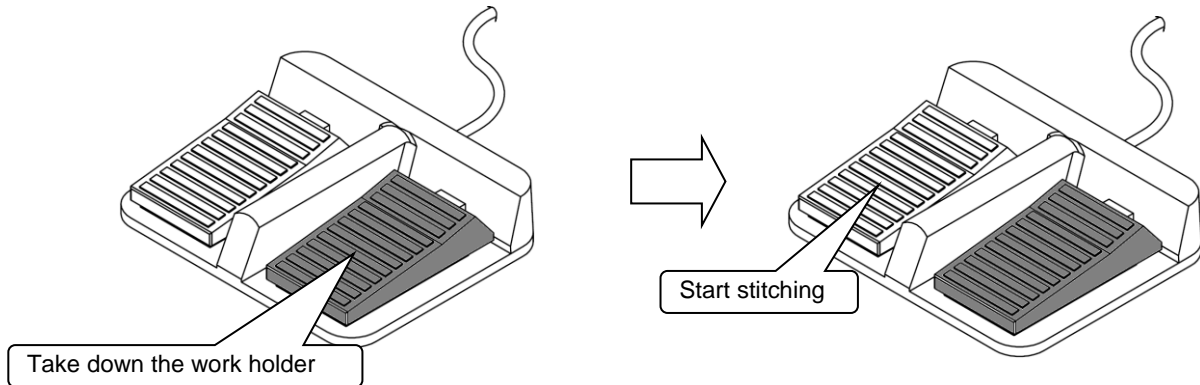

### (2) Halting.

To stop during the stitching, press the HALT switch (installed on sewing machine head; refer to following drawing). The sewing machine will stop at the needle UP position. (Standard default setting.)

To cancel the halted state, press the HALT switch again. The following operations will be possible when the halted state is canceled.

[1] Restart of stitching by pressing start switch. (gray pedal)

[2] Movement to stitching start position with forward jog/reverse jog icons.

[3] Lifting of work holder by pressing work holder switch. (black pedal)

[4] Change of stitching speed by setting stitching speed.

[5] Lifting/lowering of presser bar lifting.

[Note] The needle position during the halted state can be set with the program mode.

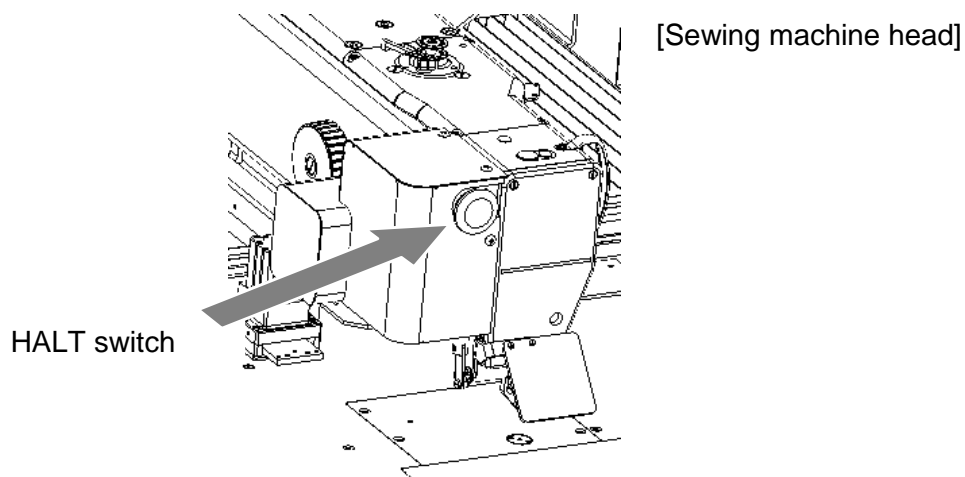

(3) Sewing methods.

Restitching can be carried out using the previously explained halt function.

If the operation is halted due to needle thread breakage, etc., set the needle at the UP position, and then using the forward jog/reverse jog icons, move to the position where the thread broke. Tie the needle thread, etc., and restart stitching by pressing the start switch.



## Caution

If the needle must be thread while the power is ON, do not turn on the start switch while threading. Doing so initiates machine rotation, resulting in an extremely dangerous situation. To ensure that the start switch is not turned on during threading, take measures such as moving the start switch away from your feet.

## 9. Adjusting the Liquid Crystal Contrast

(1) Entering the function mode.

▶ Press  on the standard screen, and open the menu mode.

▶ Press 

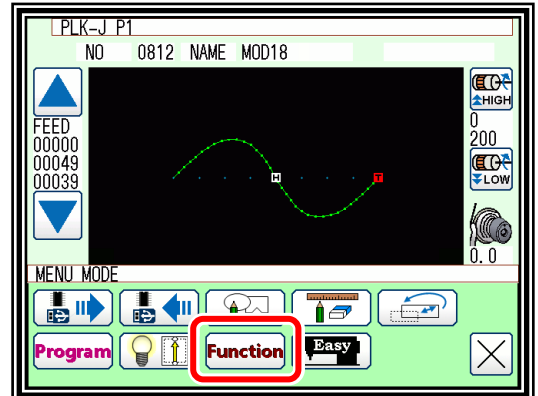

(2) Entering the screen mode.

▶ Press  on the function mode menu, and open the screen mode.

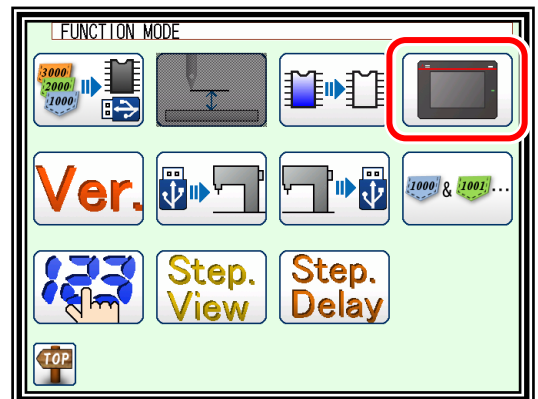

(3) Adjustment of LCD contrast.

▶ Set the liquid crystal contrast value using the up and down arrow icons.

▶ After setting the value, press the  [Enter] icon to apply the value.

▶ Back to Standard screen, then contrast setting is completed.

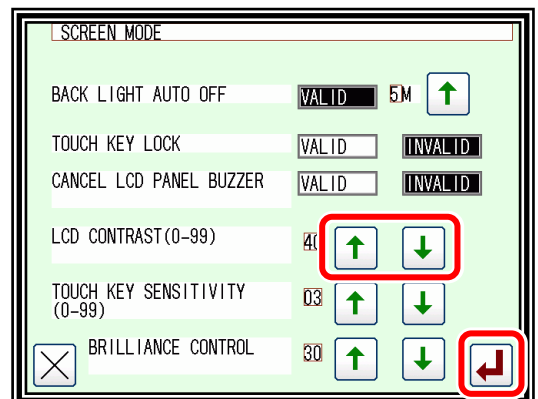

## [4] Sewing Data Compatibility

### 1. Number and type of Sewing Data

Number	Type	Explanation
0100 to 9999 (*1)	J data	This is data created with the PLK-J series. (The maximum number of stitches is 20,000 stitches.)
100 to 999	G data	This is data created with the PLK-G series. (The maximum number of stitches is 20,000 stitches.)

(\*1) Pattern data which made in J series can be registered up to 9000 (No.0100-9999) but number of the pattern in the internal memory is changed by each pattern data size.

### 2. Sewing Data Compatibility

The following table shows the handling capabilities of the sewing machine (PLK-J series) with respect to four five types of sewing data.

Type	Reading	Stitching	Continuous input, Modification and Conversion	Writing
G data	Available	Available	Available	Unavailable (*2)
J data	Available	Available	Available	Available

(\*2) Since it is converted to J data at the time of reading, it cannot be written as G data.

## [5] Reading, writing and erasing data

### 1. USB

To perform actions such as storing (reading/writing) sewing data on a device other than the internal memory or reinstalling the system, a USB device is used. The device is connected to the USB connector on the PAL. When using a USB device, be sure to fully insert the device into the USB connector. (Refer to the figure below.)

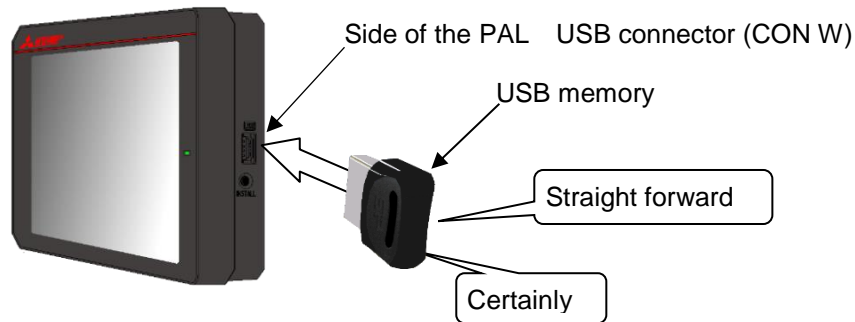

#### [Caution]

- Connect the USB device during use only. After use, remove and store the device in an appropriate location. When USB device is not connected, insert protection cap to the USB connector.  
(Protection cap must be inserted correctly according to the shape of the USB connector)
- Sewing cannot be performed with the USB device inserted.
- Do not insert the USB device during sewing.
- Be careful that nothing bumps into the inserted USB device.

#### Conditions of Application

- USB1.1 or USB2.0 or USB3.0 compatible USB memory.
- Required power supply: USB compatible, 500mA or less.

**Note** The write-protector might not be able to recognized according to the kind of USB device.  
Please make sure to release the write-protection before writing data to the USB memory.

**We recommend using the attached USB memory. If you use a USB memory other than included, you may not be able to save or read normally.**

#### Inapplicable Devices

#### ■ Never connect the following devices.

(Doing so causes malfunctions.)

- USB device requiring an external power supply. (including Computer devices)
- USB hard disk drive, keyboard, mouse.
- USB memory with fingerprint authentication function or with security function.
- USB memory with hub function.
- Media reader.
- USB device without data storage function.
- Barcode reader.



USB connector connection table.

	PAL CON W	MIF CON U	Control unit CON H
USB memory compatible 1.1 or 2.0 or 3.0 only	Yes	Yes (*1)	No
Barcode reader	No	Yes	No
PC	No	No	Yes
Other USB device	No	No	No

(\*1) Only installation files can be imported.

For details of I/F board (MIF) and control box, refer to "section [13]" and "section [14]" in TECHNICAL MANUAL "Control Unit".

Folder structure

	Folder name	File extension
Setting file Step file	USER_system	*.JTL *.JEP *.JST
System file (install file)	PLKJ_SYSTEM	*.BIN *.PLK
Pattern	PATTERN	*.PTJ
Sewing guide setting data	PLKJ_GUIDE	*.JSD

For sewing data, refer to "section [4]".

## 2. Reading

### Operation points

- Select “Read mode” from the menu.
- Select the target (internal memory/USB memory).
- Select the data, and execute reading.

### Operation details

#### (1) Selecting data read.

**Note** Data reading excluding the start position cannot be executed. Read pattern data after home returning.

▶ Press  on the standard screen, and open the menu mode.

▶ Press .

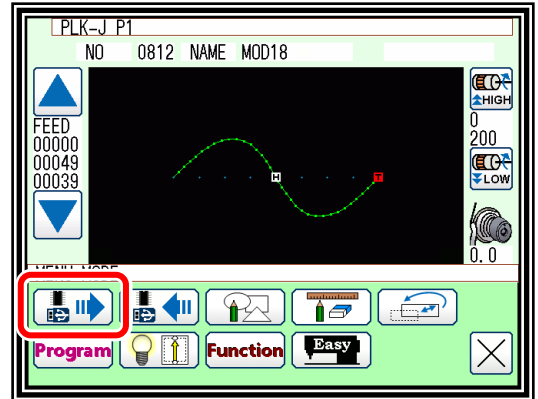



#### (2) Select the target. (internal memory/USB memory).

##### 1. Internal memory

▶ When the screen first opens, the mode to read from the internal memory is selected.



(The mode display at the upper left of the screen is )

▶ Press  to change to reading from the USB memory.

(The mode can also be changed by pressing )





**Note** If the USB memory is not inserted into the USB connector, USB memory icon can not be selected.

▶ If there is a large amount of data, press   to change the screen.



##### 2. USB memory

▶ First, the data of the USB memory of the first hierarchy is displayed.

(The mode display on the upper left of the screen is )

▶ Press  to move to the folder.

(Only up to the third hierarchy is displayed.)

(To display the internal memory, pressing  or  switches it.)

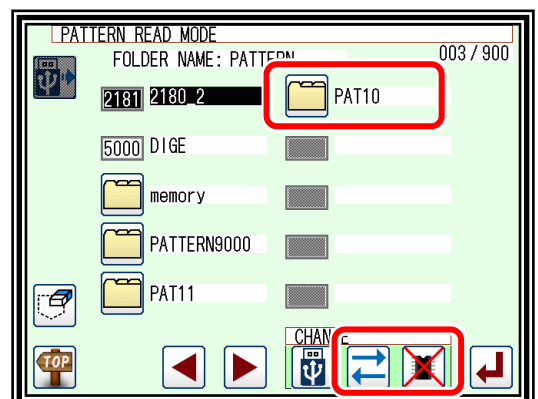

▶ When you press  , it moves inside the folder and the display of the FOLDER NAME at the top of the screen is changed.

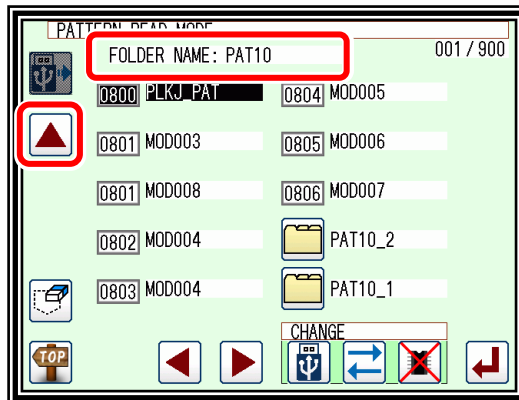

 is displayed, and when pressed it returns to the upper hierarchy.

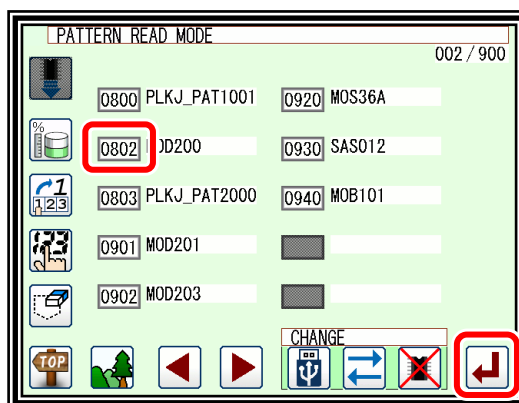

(3) Selecting and setting the data.

▶ Press the number of the data to be read, and then press .



**Note** When you read data from the USB memory and select a data number that already exists in the internal memory, a message confirming that you overwrite the data appears. If you do not overwrite the data, press the  icon. If you overwrite the data, press the .

▶ The read data will be displayed.

(4) Data reading complete.

▶ The read data will be displayed.

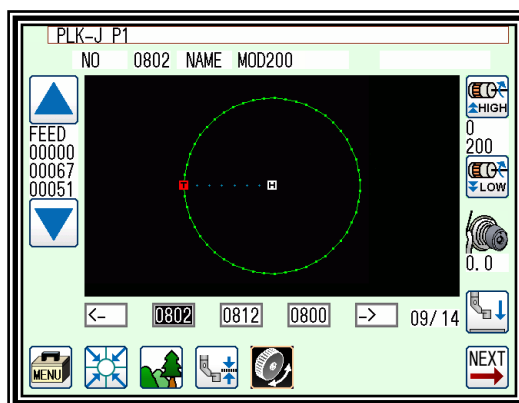

**⚠ [Caution]** When the target is the USB memory, do not remove the USB memory during reading. (Doing so may result in data damage.)

**Note** When the pattern data number is already known, it is possible to read by specifying the number directly by the following operations.  
(Following operation is limited to reading from an internal memory.)

## Reading [Direct reading mode]

### Operation details

(1) Selects pattern data read button.

**Note** Data reading excluding the start position cannot be executed. Read pattern data after home returning.

▶ Press , then menu screen is displayed.

▶ Press .

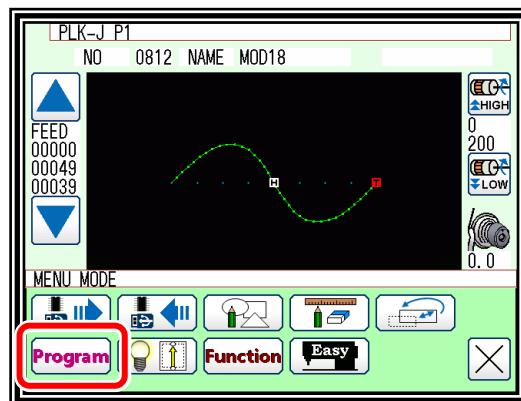

(2) Selects direct pattern number selection.

**Note** Direct pattern number selection is possible only to the data stored into the internal memory.

▶ Press direct pattern number button .

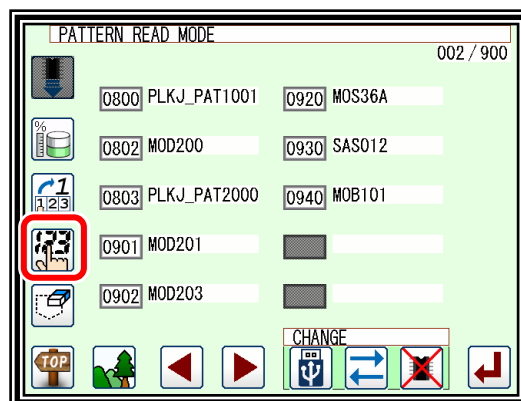

(3) Specifies pattern data number 1.  
(example. Case of reading number [0861].)

▶ Press number button [08].

**Note** When "8" is first entered, the 8000 series is displayed.

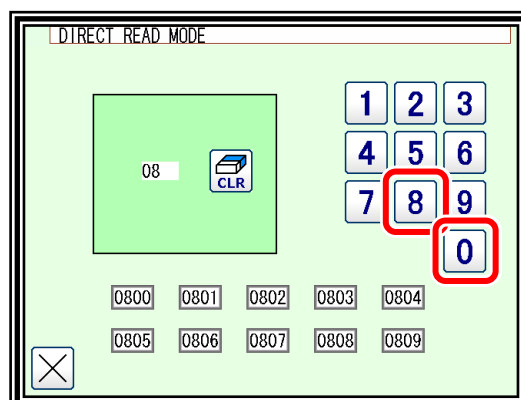

▶ Data in the internal memory are displayed by the lower ten icons.  
It is displayed from an input small data number to begin with "08" in turn.

(4) Specifies pattern data number 2.

▶ Next press number button [6].

▶ Then all pattern data which number starts from 86 is displayed.

▶ At this time, desired pattern number [0861] is displayed, then press .

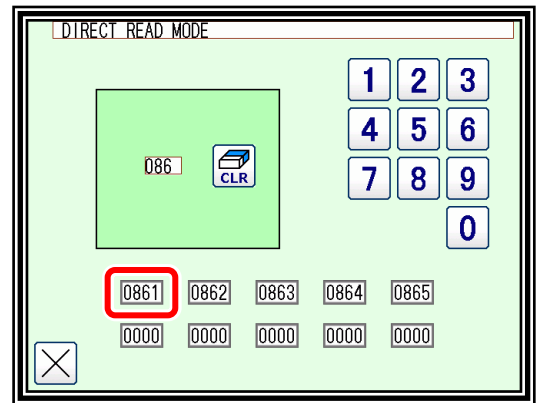

**Note**

It is also available, if inputs 3 digits in the column as [0861] and push  button.

(5) Data read complete.

▶ Standard screen with the figure of pattern number [0861] is displayed.

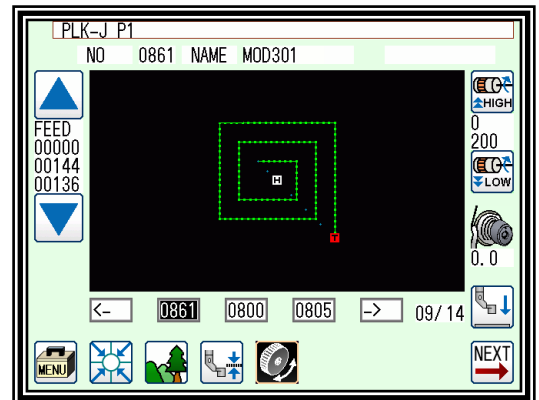



### 3. Writing

#### Operation points

- Select "Write mode" from the menu.
- Select the target (internal memory/USB memory).
- Set the pattern name and number, and execute writing.

#### Operation details

##### (1) Selecting data write.

- ▶ Press  on the standard screen, and open the menu mode.
- ▶ Press .

**Note** Data writing excluding the start position cannot be executed. Write pattern data after home returning.

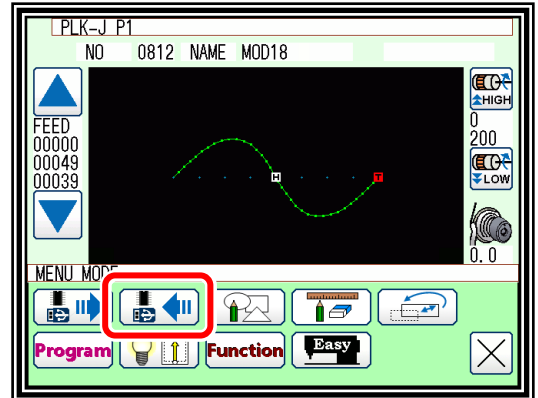

##### (2) Setting the pattern number and name.

###### 1. Internal memory

- ▶ When the screen first opens, the mode to write to the internal memory is selected.

(The mode display at the upper left of the screen is



- ▶ Press  to change to writing to the USB memory.

(The mode can also be changed by pressing .)

**Note** If the USB memory is not inserted into the USB connector, USB memory icon can not be selected.

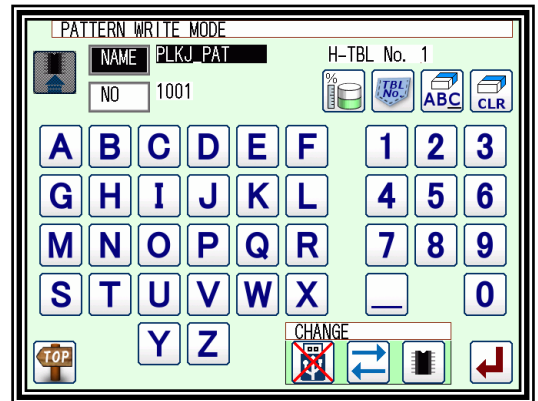

- ▶ Set the pattern number and name.

Press  , and to change the name

Press  . Highlight the icon, and then change the setting.

When the  icon is pressed, one of the alphanumeric characters from the right can be deleted from

the pattern number or name. If press the  icon, all character is deleted.

(The pattern name can have up to twelve characters. Specify the pattern number within the range of "0100" to "9999".)

###### 2. USB memory.

(Switching cannot be done unless USB is inserted)

- ▶ Please press the button to switch to the USB memory.

(The mode display at the upper left of the screen is





- ▶ Press  to change to writing to the Internal memory.

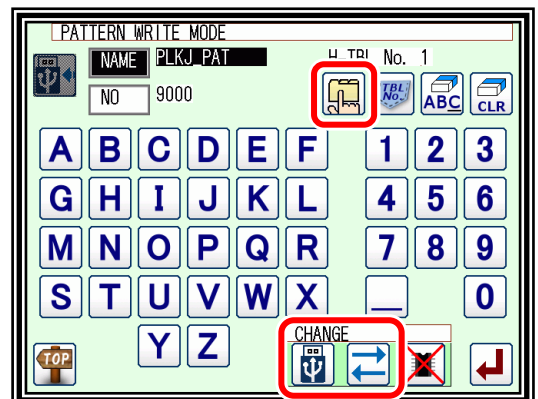

(The mode can also be changed by pressing .)

- ▶ By pressing Folder specification  , The folder of the save destination is selected.



▶ When  is pressed in pattern write mode, the folder screen is displayed as shown on the right.

Select  as the save destination and press  to move to the folder.

Select  as the save destination and press , the selected folder becomes the save destination and it moves to the written screen (3).

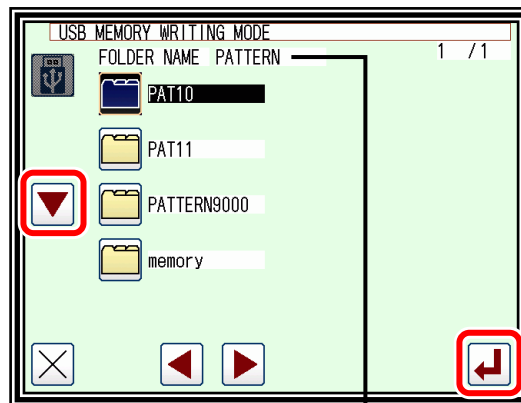

**Note** If folders are not created in the "PATTERN" folder beforehand, folders are not displayed.

▶ When  is pressed and it moves to a folder, the display of FOLDER NAME changes to the name of the selected folder.

▶ In addition,  is displayed when moving to a folder, and when pressed it returns to the next higher level.

In this case, since the "PAT10\_1" folder in the "PAT 10" folder is selected, pressing  puts the save destination to "PAT10\_1".

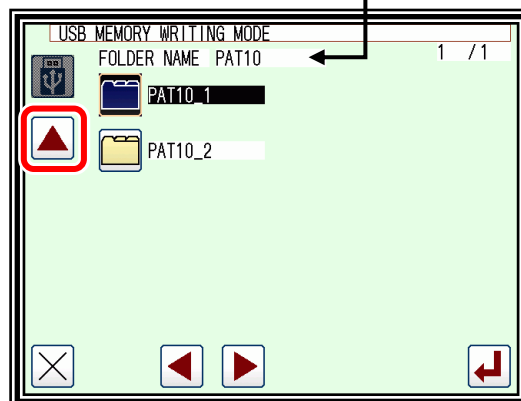

### (3) Starting writing.

▶ Like the internal data, press the pattern number and name to set each.

▶ To start writing, press  on the write mode screen. (same for internal data storage.)

**Note** If you try to write a data number that already exists for the write target, a message confirming that you overwrite the data appears. If you do not overwrite the data,

▶ The standard screen will reappears.

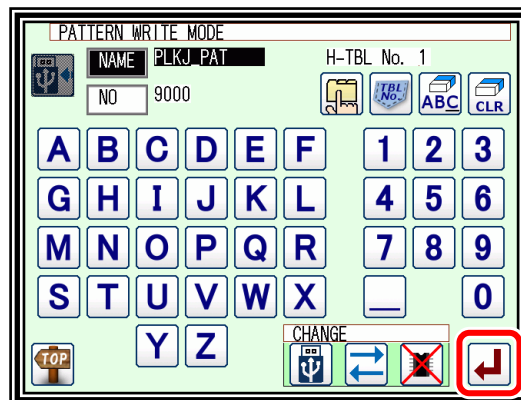

### Sewing data save destination.

"PATTERN" folder	hierarchy1	hierarchy2	hierarchy3
folder	Yes	Yes	-
pattern	Yes	Yes	Yes

**Note** Save is limited to "PATTERN" folder.

If you save data without selecting the folder, it will be saved directly under the "PATTERN" folder. The folder is displayed from "PATTERN" to the hierarchy under two. When saving without "PATTERN" folder, "PATTERN" folder is created and data is saved there. Since the folder name in "PATTERN" can not be created / changed, please execute it with PC etc.

**[Caution]** When the target is the USB memory, do not remove the USB memory during writing. (Doing so may result in data damage.)

## 4. Erasing

### Operation points

- Select "Read mode" from the menu.
- Select the target (internal memory/USB memory).
- Select the data, and execute erasing.

### Operation details



#### (1) Selecting data erase.

- ▶ Press  on the standard screen, and open the menu mode.

- ▶ Press .

**Note** Data erasing excluding the start position cannot be executed. Erase pattern data after home returning.

- ▶ Press (Select) the number of the data to be erased, and press .

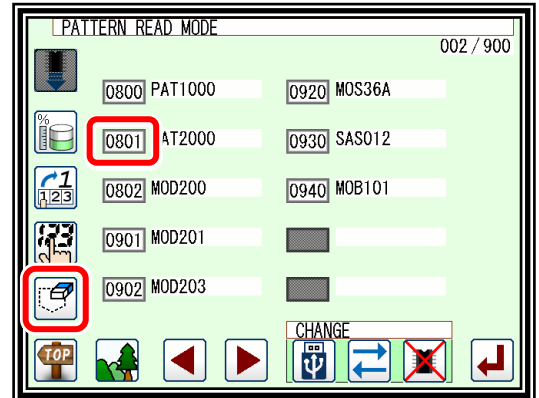

- ▶ To erase from USB memory, press  or .

**Note** USB memory must be inserted to switch target to USB memory.



#### (2) Confirmation of the erase target.

- ▶ An erase confirmation message will be displayed.

- ▶ A message confirming that you erase the data appears. If you cancel the erase operation, press the  icon. If you execute the erase operation, press the  icon. A message indicating that erasing is in progress appears, and then the Standard screen reappears.

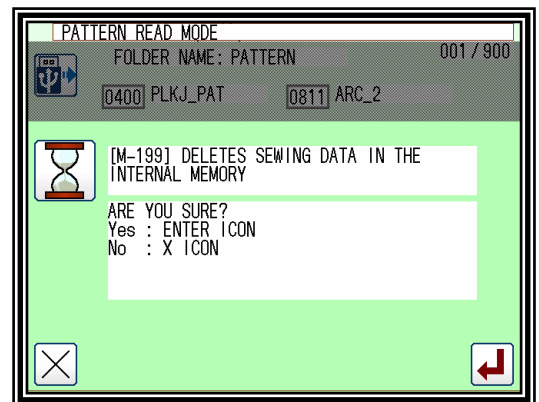

#### (3) Data erase complete.

- ▶ Erase completed. (0801 is erased.)

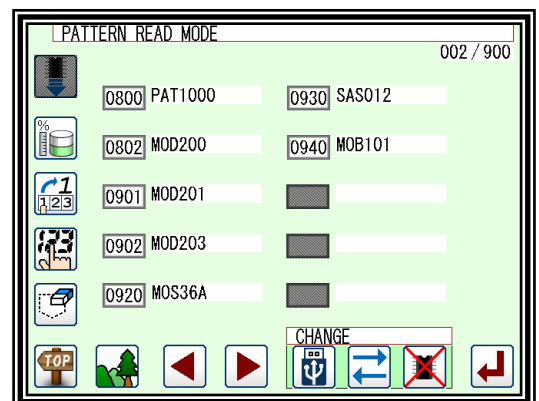

**⚠ [Caution] When the target is the USB memory, do not remove the USB memory during erasing. (Doing so may result in data damage.)**



## 5. Reading data with shortcut icons (Reading from internal memory)

**Note** Data can be read out with easy operations.

### Operation details

Reading data.

- ▶ Use the icon under the image area of the standard screen for call-up operation.  
(No.0802 is used as an example here.)
- ▶ Press  to sequentially display the No. icon for the data written in the internal memory from left to right. (\*1)
- ▶ Press  to sequentially display the No. icon for the data written in the internal memory from right to left. (\*1)

(\*1) 20 data recently used are stored.

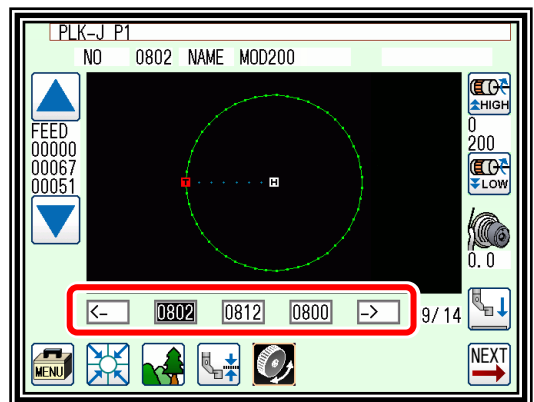

- ▶ Press the  (No. icon). The data written in the internal memory will be called out.  
(The data having the number indicated on the icon will be called out.)

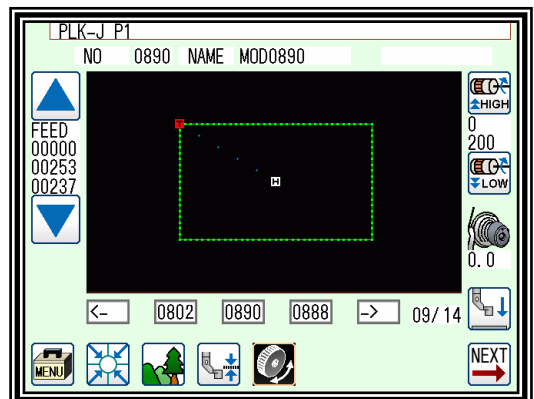

## 6. Rename the data number

**Note** The number of the data that was saved in an internal memory can be changed.

### Operation details

(1) Selecting data read.

▶ Press  on the standard screen, and open the menu mode.

▶ Press .

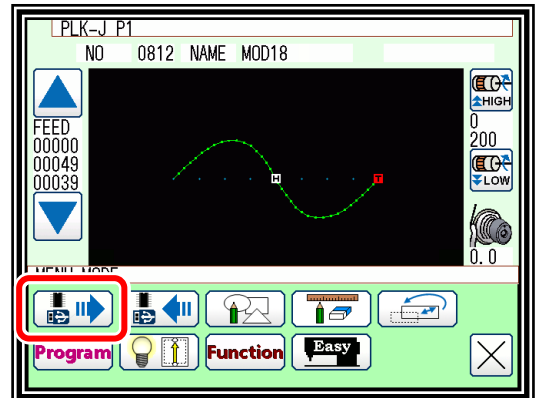

(2) Selecting the data.

▶ Selecting the number of the data that wants to change and press .

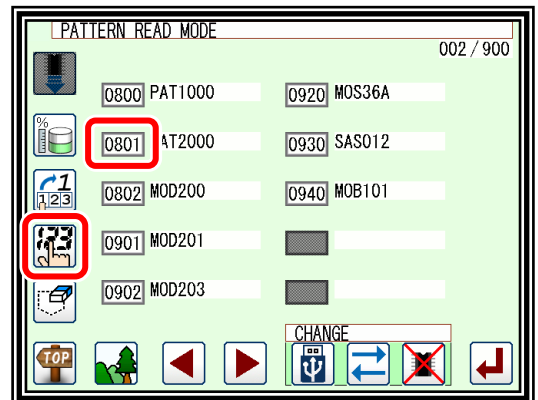

(3) Specifies number.

▶ Specifies the number that wants to change using the numeric key.

▶ Press  after specifying.

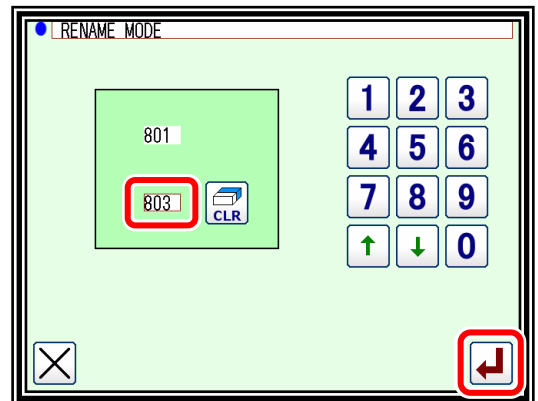

(4) Completing change.

▶ The number of "0801" was changed to "0803" in this example.

▶ To return to the standard screen, press .

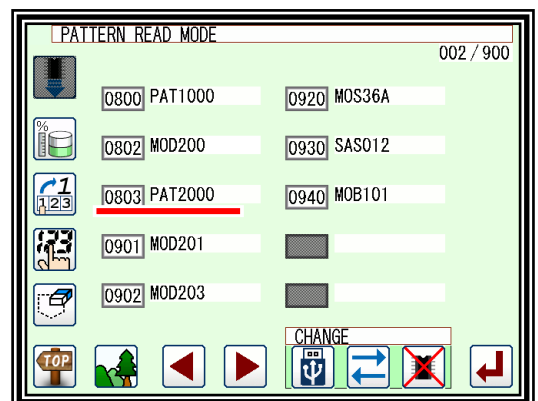

# [6] Creating stitching data

## 1. Flow of data creation

The flow of creating simple stitching data, as shown below, is explained in this section.

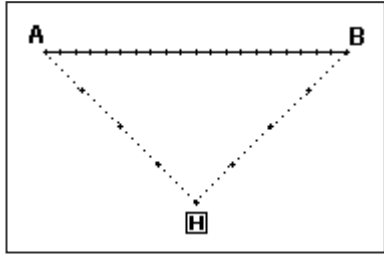

[Sample Fig.1]

The flow of operations for creating data and the transition of screen displays are explained here.

(1) Start from the standard screen.

► Press 

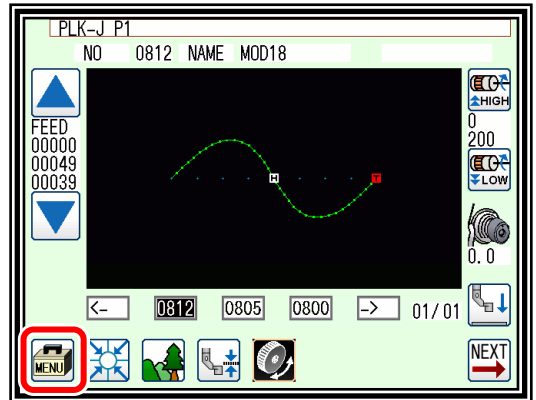



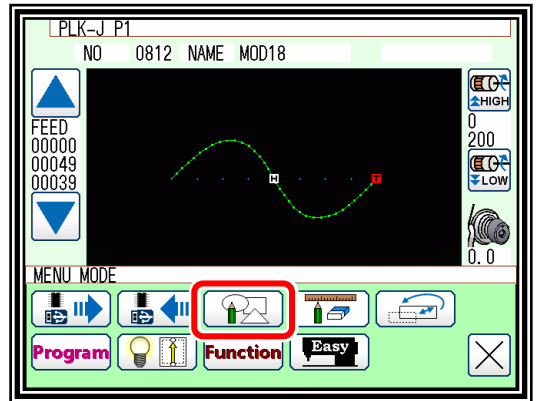

(2) The menu mode will open.





► Press 



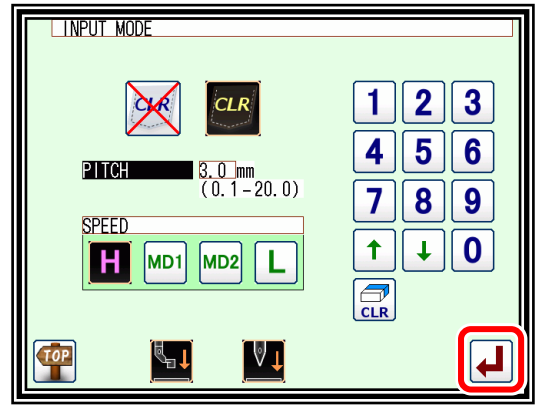





(3) The "INPUT MODE" screen will open.

- ▶ If the data has not been input on the standard screen, the  and  icons will not appear. To clear the input data and input new data, press . To continuously input after the data already input, press .





- ▶ Set the speed.     High speed Medium-1 speed Medium-2 speed Low speed

- ▶ Set the  length. Set in the range of 1 (0.1mm) to 200 (20.0mm) using the  to  and ,  icons.

- ▶ When completed setting the data, press .

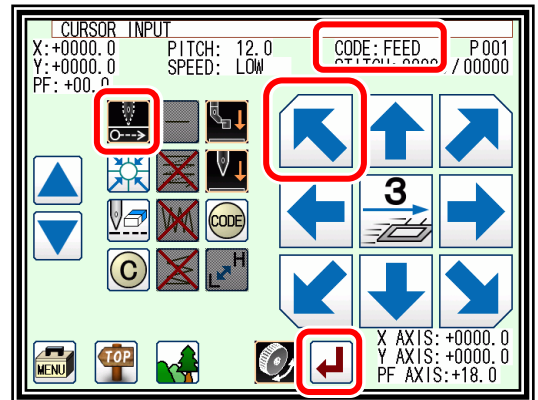

(4) The arrow input screen will open. (Input the sample Fig. 1 data.)

- ▶ When this screen is first opened, the code is set to FEED ( is selected.) Press  and move to the position (A point) for starting stitching. (Movement using the arrow mark icons will change the X and Y position values displayed on the screen.)



- After moving, press , and set the current position.

(Data on feed data to point A will be created and  is canceled.)

- ▶ Next, the code is set to SEW (sewing), so press  and move to the position (B point) for ending stitching. After moving, press , and set the current position. (Data on straight stitching to point B will be created.)

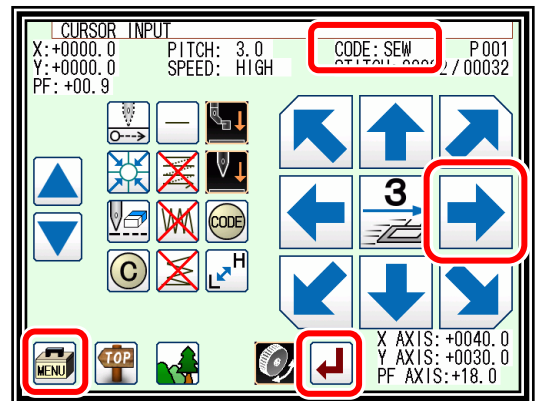

- ▶ Next, press .

(5) The "INPUT MODE" menu will open.

▶ When  is pressed, the work holder will return to the home position, and inputting of data will be completed. (Data on feed data to the home position and the end code will be created.)

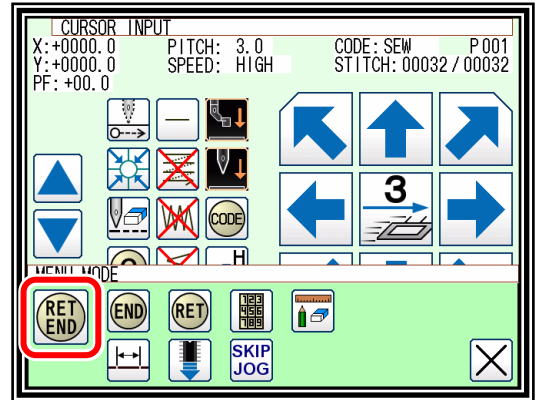

 **Caution** The work holder will automatically return to the home position. Take care when the needle is lowered, etc.

(6) A prompt for home position return will appear.

▶ Press .

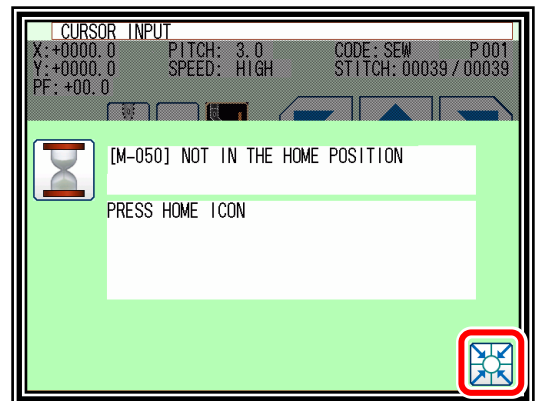

 **Caution** The needle will rise to the UP position. If the needle is not at the UP position, it may lower once and then return to the UP position.

(7) Select a saving method.

▶ After selecting the saving method, press  icon.  
(Refer to page [5] - 7.)

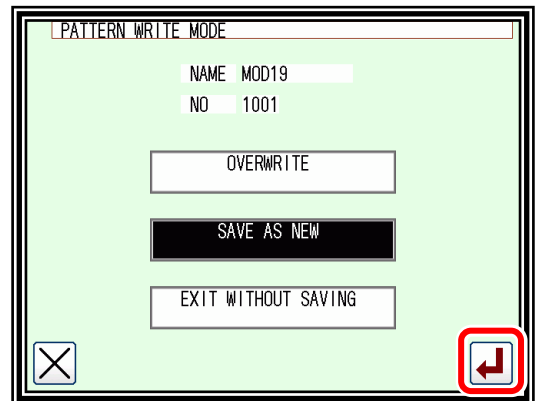

(8) The Standard screen will open.

▶ Return to the Standard screen and confirm the input data.  
  
▶ This completes the input.

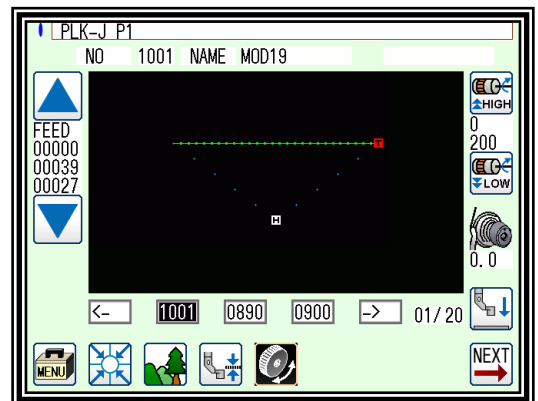

## 2. Description of arrow input screen

The arrow input screen is described below.

The screenshot shows the 'CURSOR INPUT' screen with the following data: X: +0000.0, Y: +0000.0, PF: +00.9, PITCH: 3.0, SPEED: HIGH, CODE: SEW, STITCH: 00032 / 00032, P: 001. The screen contains a grid of icons for navigation and settings, and a central display showing the number '3'. Callouts [1] through [6] point to specific icons and data fields.

[1] → The current status will be displayed.  
 "STITCH": Shows the "current needle position value/total number of stitches".

When the needle is at the final stitch (current needle position value = total number of stitches)

"X, Y": Shows the position values entered with the arrow mark icons.  
 "Stitch length", "speed", "code" : Shows the currently-set values.  
 "P": Shows the number of points entered for an arc, curve, etc.

During operation in the jog mode (current needle position < total number of stitches)

"X, Y", "Stitch length", "speed", "code" : Shows the needle data of the specified position.

Displays XY current stitch position as an absolute value based on the home position.

When the needle is at the final stitch (current needle position value = total number of stitches)

Arrow mark icons will appear and data entry will be possible. To enter the position value, move the work holder using the arrow mark icons.

During operation in the jog mode (current needle position < total number of stitches)

[The image currently creating will be displayed.

### [1] "Data entry method setting icon".

The basic data entry method currently set will appear. (Point, straight line, broken line, circle, arc, curve) Press this icon to display the data entry method setting screen.

### [2] "Multi-stitching, reverse multi-stitching, offset data setting icon".

The multi-stitching, reverse multi-stitching, and offset data currently set will appear. (Not set, multi-stitching (feed data mode), reverse multi-stitching (feed data mode), multi-stitching (sewing mode), reverse multi-stitching (sewing mode), offset) Press this icon to display the multi-stitching, reverse multi-stitching, offset data setting screen. Using this screen, you can set detailed data.

### [3] "Zigzag setting icon".

The zigzag currently set will be displayed (zigzag or non-zigzag). Press this icon to display the detailed zigzag data setting screen. Using this screen, you can set the detailed zigzag data.

### [4] "Back tack setting icon"

The back tack currently set will appear. (No back tacking, start/end back tacking, overlap back tacking) Press this icon to display the detailed back tacking data setting screen. Using this screen, you can set detailed back tacking data.

### [5] "Kind of code display".

FEED	-----	Feed.
FEND	-----	Feed end cord. (Displayed while JOG is operating.)
SEW	-----	Basic input. (Straight line, Arc, Circle, Curve, Broken line, Point.)
P	-----	Multiple sewing.
I	-----	Reverse multiple sewing.
O	-----	Offset sewing.
Z	-----	Zigzag sewing.
B	-----	Back tacking sewing.

(Others, the various code data is displayed while JOG is operating.)

[6] [Clamp speed switch icon].



: Normal



: A little slow



: Slower

(Icon is changed whenever icon is pressed for a long period.)



“Cancel”: Cancels the last operation, and returns to the previous data entry point.



**Caution** The work holder will move. If the needle is lowered, be careful not to get injured.



“Delete last point”: Deletes the last determined point, and returns to the previous data entry point.



**Caution** The work holder will move. If the needle is lowered, be careful not to get injured.



“Change sewing speed”: Each time you press this icon, the set speed will be changed in the order of “HIGH → LOW → MD2 → MD1 → HIGH.”



The image display screen will be displayed.

State of ICON

SAMPLE 1

Valid state  
The icon is always selected.  
(FEED icon is in the valid state.)

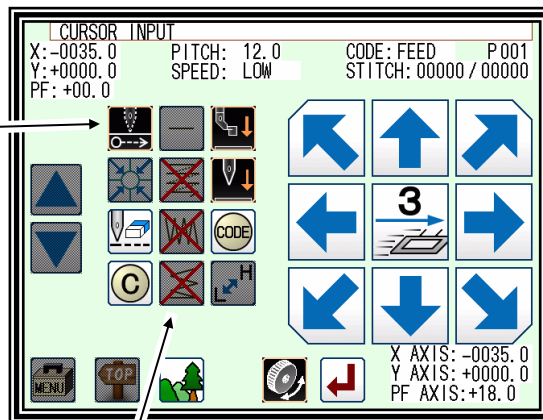

Unselect able state Icon cannot be selected (icon is shaded)  
Since FEED icon is in the valid state, the sewing method cannot be selected.

SAMPLE 2

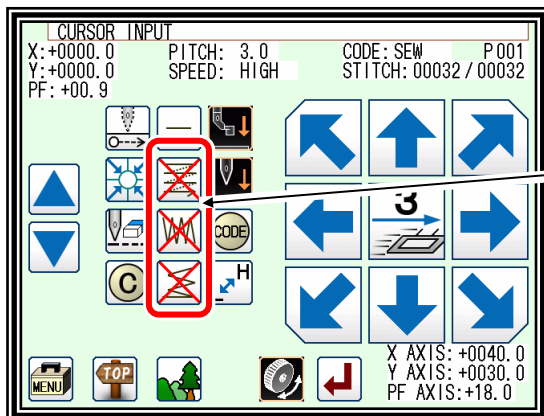

Since "x" indicates an unused icon, it is possible to set the sewing method by pressing the icon.

Now it is "x"

- Multi-stitching / offset data setting icon = unused
- Zigzag setting icon = unused
- Back tack setting icon = unused

SAMPLE 3

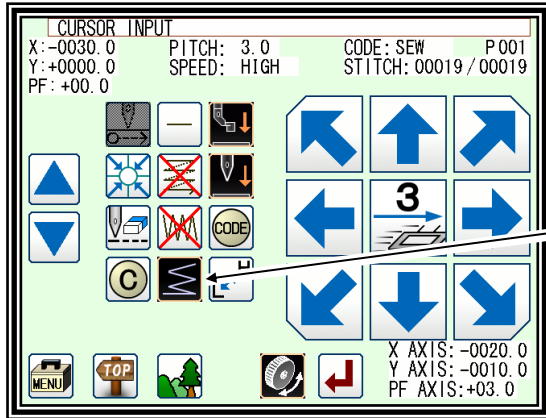

Back tack setting icon = Valid state.  
(Back tacking setting in use.)

### 3. Description of menu

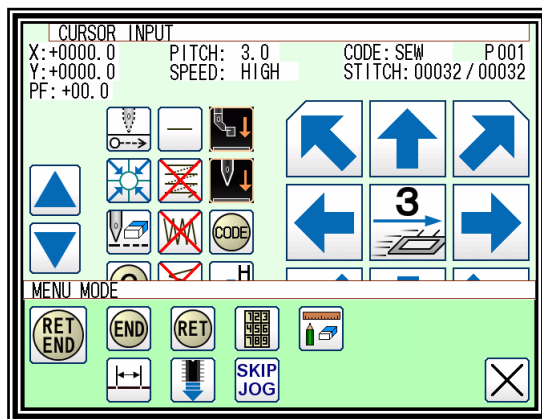

... The data on feed data from the current position to the home position and the end code will be created, and the system will exit from the input mode.



... The end code will be created, and the system will exit from the input mode.



... The data on feed data from the current position to the home position will be created.



... The screen is switched to the data creation screen that enables direct entry of numeric values.



... The screen is switched to the input screen that enables data entry using the arrow mark icons (the arrow mark icons move the work holder).



... You can enter the modification mode.



... The stitch length change screen will appear.



... When inputting data, the stitching data saved in the internal memory is added to the end of the data being input.



... The skip jog setting screen will appear. (The details are explained on the next page.)



## 4. Skip jogging

Skip jogging allows movement to the target needle position at a faster speed than normal jogging. Skip jogging can be used in the input, modification and conversion modes.

- (1) Turning skip jogging ON/OFF, and displaying the setting screen.

- ▶ Press  found on the input screen menu, the modification mode and conversion mode.

(The explanations are made with the Modification Mode screen.)

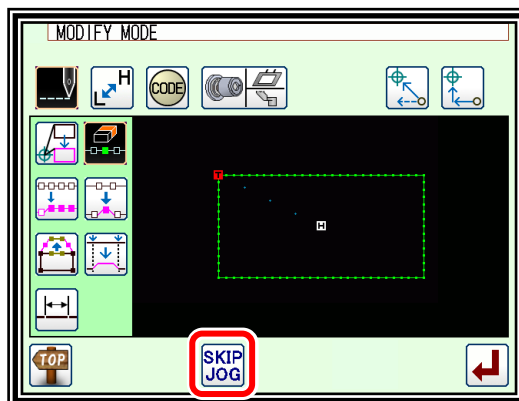

- (2) Setting skip jogging.

- ▶ Determine whether to use (ON) or not use (OFF) skip jogging.

 : Do not use. (OFF)

 : Use. (ON)

- ▶ Determine the movement method.

 : Move linearly.

 : Move along a path.



- ▶ Using the numeric keypad, set the number of movement stitches.

- ▶ Determine the function output method.



 : The output signal is invalid.

 : The output signal is valid.

- ▶ After setting, press 

- (3) Skip jog operations.

”For example, In Modify mode, open the Stitch Delete screen.”

Skip jogging will start when  and  are pressed. Stitch number: 50 and when the movement method is . It moves linearly by 50 stitches at a time.

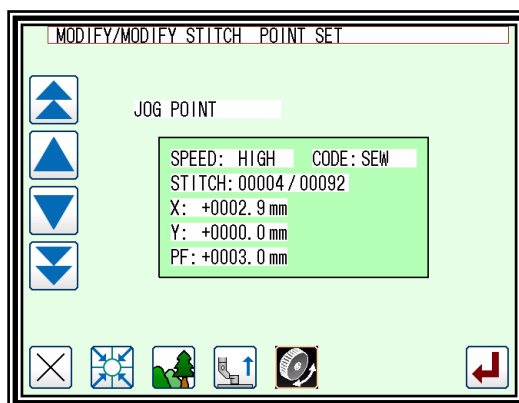

Note

Skip jogging will stop if one of     is pressed.

# [7] Methods of creating sewing data



**Caution** Note that the needle will rise to the UP position when the "Home position Return" icon is pressed. (If the needle is not at the UP position, it may lower once and then return to the UP position.) By removing the presser bar lifting from sewing machine, data can be input safely and accurately.

## Basic Inputs

Function	icon	Explanation
Linear (page [7]-1)		2-point input: A linear line is created between the current position (already input) and the newly input point.
Arc (page [7]-4)		3-point input: An arc, passing through the current position (already input) and two newly input points, is created.
Circle (page [7]-8)		3-point input: A circle, passing through the current position (already input) and two newly input points, is created.
Curve (page [7]-11)		A curve passing through the current position (already input) and the input point (up to 300 points possible) is created.
Broken line (page [7]-15)		A broken line connecting the current position (already input) and the input point (up to 300 points possible) is created.
Point (page [7]-18)		The point can be input one stitch at a time. ‡ The distance between the points must be within 20mm.
Code (page [7]-20)		The code by which various controls are done can be input.

## 1. Linear input



### Operation points

- Designate linear input.
- Input two points (A linear line is created between the current position (already input) and the newly input point.)

[Example] The following type of sewing data will be created.

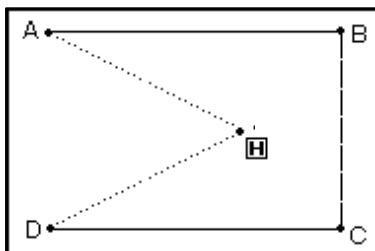

### Operation details

(1) Inputting feed data to A point.

- ▶ Press and on the Standard screen.



After making the various settings on the Data Setting Input screen, the Arrow Input screen will open.  
(Refer to page [6] - 4)

- ▶ Check that the code is set to FEED. If different code is set, press and set the code to FEED.

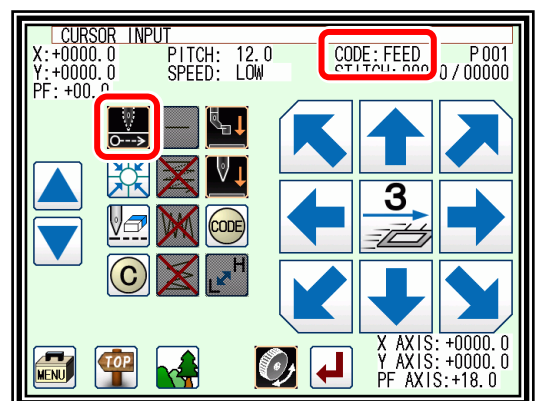
- ▶ Press the arrow icons and move to the A point.  
(Feed data to A point.)



(2) Setting feed data to A point.

- ▶ The movement amount can be confirmed.  
[Example] X: -40.0, Y: +20.0
- ▶ Press  to set the data.  
(Data on feed data to point A will be created.)
- ▶ The movement amount will be cleared.  
X:+0.0, Y:+0.0
- ▶ The code will change to "SEW".  
(  will be available.)

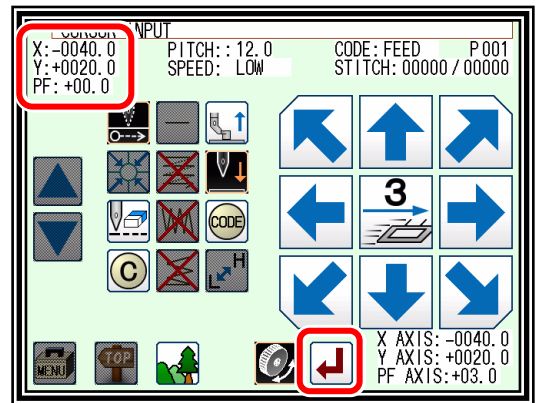

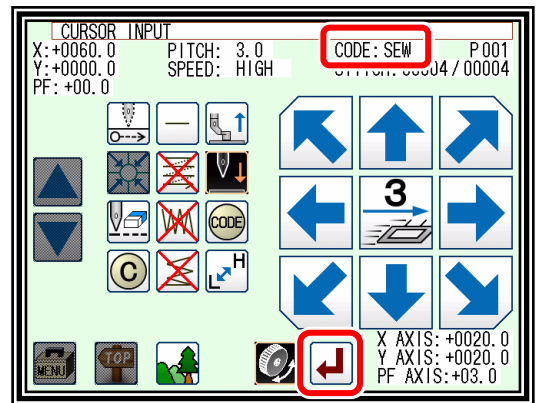

(3) Inputting stitching to B point.

- ▶ Since it is linear line icon, move to point B by pressing the arrow icon.
- ▶ Press  to set the data.  
(Data on straight stitching to point B will be created.)



(4) Inputting stitching from C point to D point

- ▶ Press the arrow icons and move to the C point.  
Press  to set the data.  
(Data on straight stitching to point C will be created.)
- ▶ Press the arrow icons and move to the D point.  
Press  to set the data.  
(Data on straight stitching to point D will be created.)

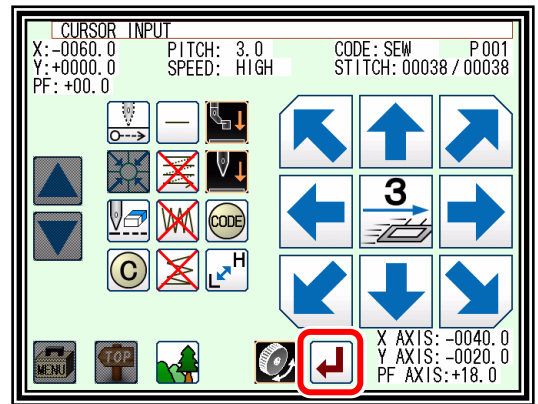

(5) Setting stitching to D point.

- ▶ Press .

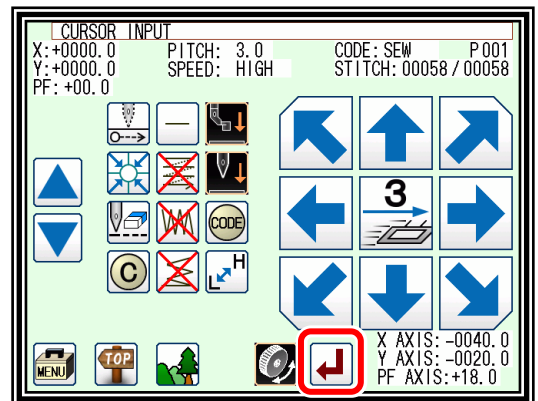



(6) Inputting the return/end code.

▶ Press .

(Data on feed data to the home position and the end code will be created.)

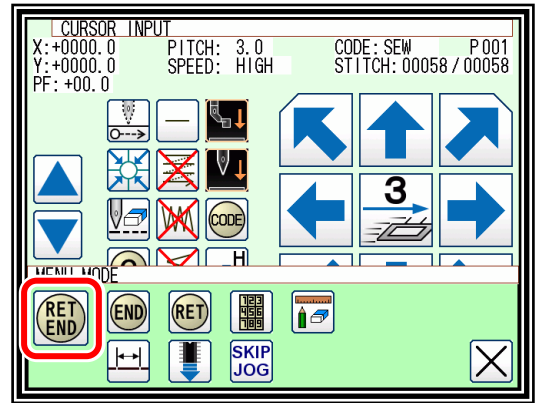
 **Caution** The work holder will automatically return to the home position. Take care when the needle is lowered, etc.



▶ A prompt for home position return will appear. Press .

 **Caution** The needle will rise to the UP position. If the needle is not at the UP position, it may lower once and then return to the UP position.

(7) Select a saving method.



▶ After selecting the saving method, press  icon.

(Refer to page [5] - 7.)

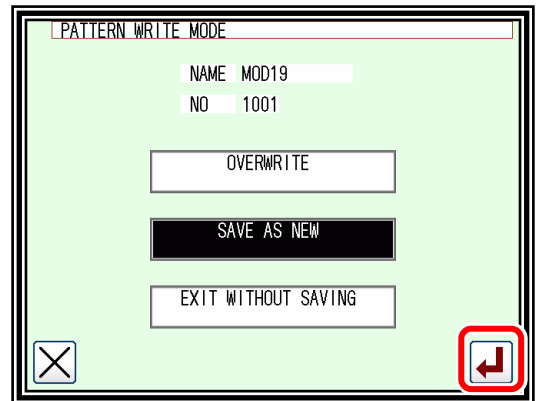
▶ Return to the standard screen.



(8) Confirming the data.

▶ Confirm the data. Press the jog icons ( ) so the sewing machine movement can be confirmed.

(Even if the data input has not been completed, if the data input last has been set, the movement can be confirmed in the same manner.)

▶ If the data must be modified, refer to “section [11]”.

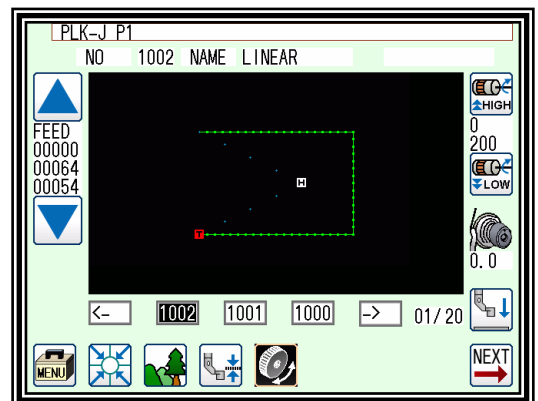

## 2. Arc input

### Operation points

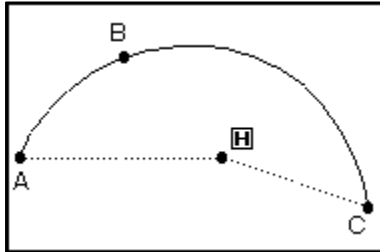

- Designate arc input
- Input three points (An arc, passing through the current position (already input) and two newly input points, is created.)

[Example] The following type of sewing data will be created.



### Operation details

(1) Inputting feed data to A point.

- ▶ Press  and  on the Standard screen. After making the various settings on the Data Setting Input screen, the Arrow Input screen will open. (Refer to page [6] - 4)
- ▶ Check that the code is set to FEED. If different code is set, press  and set the code to FEED.
- ▶ Press the arrow icons and move to the A point. (Feed data to A point.)

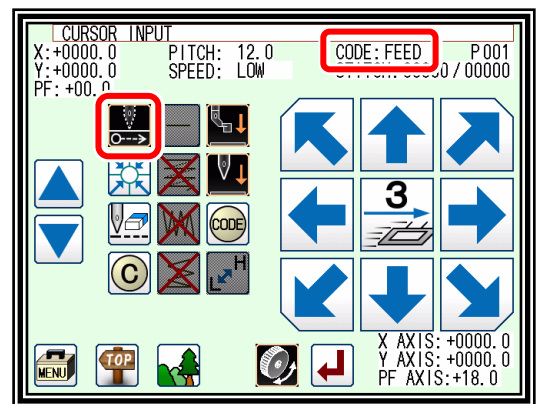

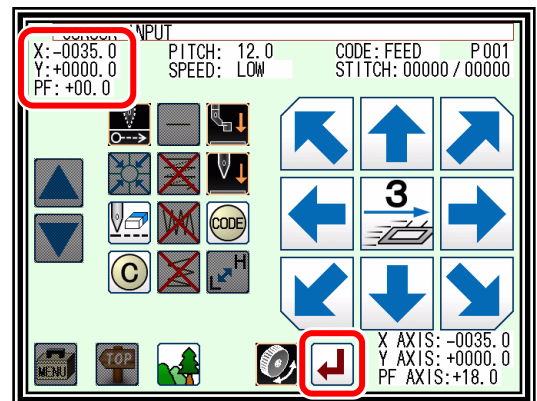

(2) Setting feed data to A point.

- ▶ The movement amount can be confirmed.
- ▶ Press  to set the data. (Data on feed data to point A will be created.)



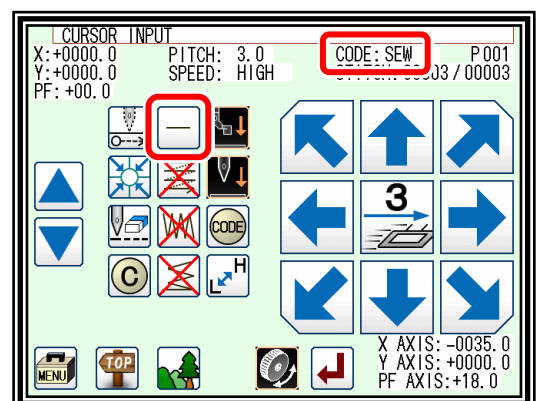

(3) Changing the input method.

- ▶ The movement amount will be cleared.
- ▶ The code will change to "SEW".
- ▶ If the stitching type is not  "ARC INPUT", (if the type is  "LINEAR INPUT"), press  and change the type. (The currently set stitching type will be displayed on the icon.)



(4) Designating arc input.

▶ Press  and then press .

▶ The system will return to the arrow input screen.

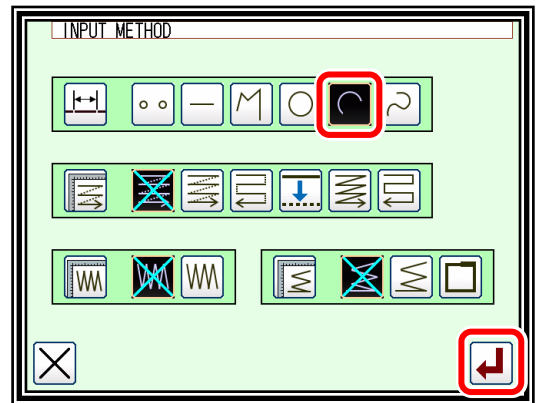

(5) Setting B point and C point.

▶ Press the arrow mark icon to move to point B.

▶ The movement amount can be confirmed.

Press  to determine point B.

▶ Press the arrow mark icon to move to point C.

Press  to set the arc input.

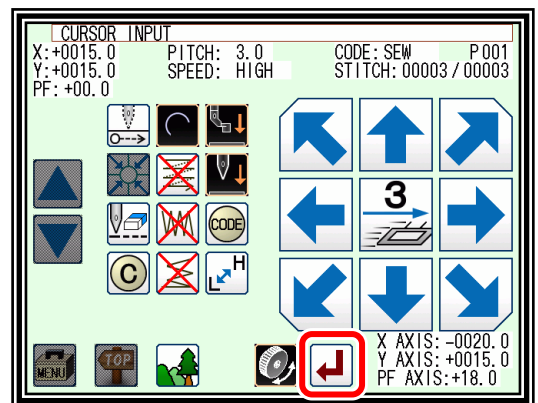

(6) Creating the arc input data.

▶ The confirmation message "Create arc" will appear.

▶ Press  to return to the point C data entry screen.

▶ Press  to start creation of the arc input data.  
(The arc will be created.)

▶ A message indicating that the data is being created will appear.

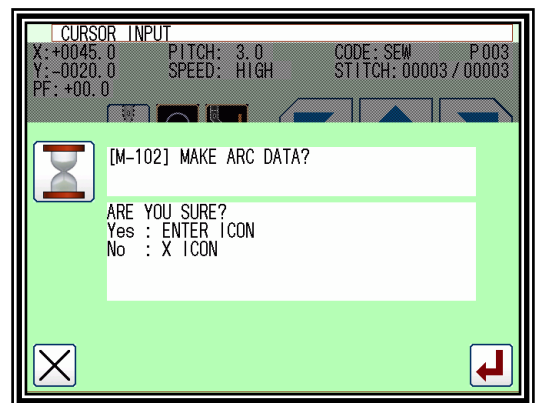

(7) Completing creation of the arc input data.

▶ Press .

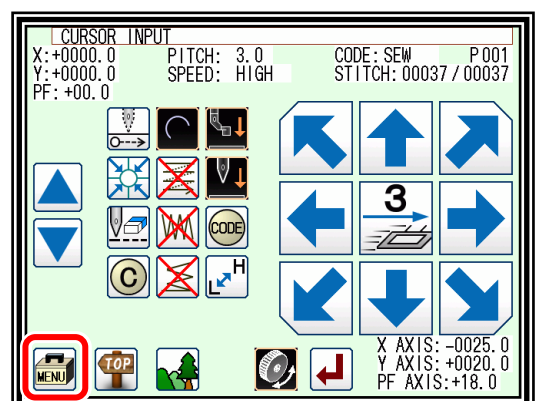



(8) Inputting the return/end code.

▶ Press  .

(Data on feed data to the home position and the end code will be created.)

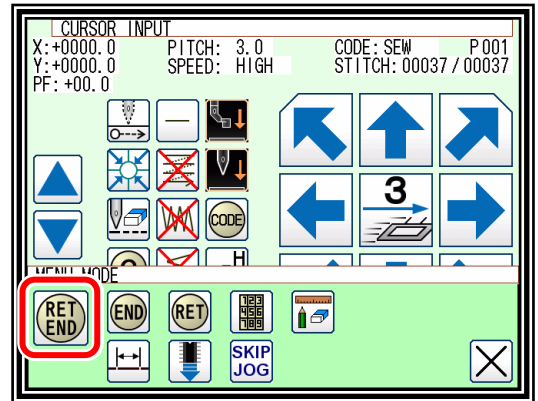
 **Caution** The work holder will automatically return to the home position. Take care when the needle is lowered, etc.



▶ A prompt for home position return will appear. Press  .

 **Caution** The needle will rise to the UP position. If the needle is not at the UP position, it may lower once and then return to the UP position.



(9) Select a saving method.

▶ After selecting the saving method, press  icon.  
(Refer to page [5] - 7.)

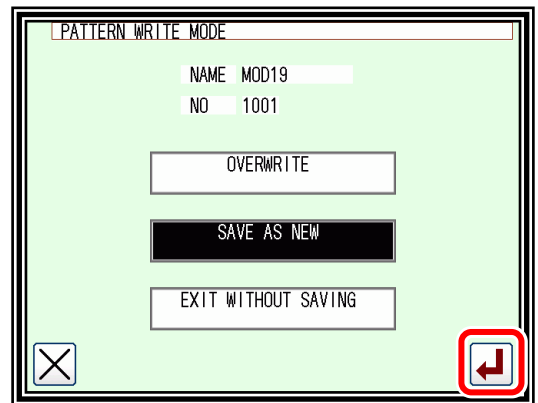
▶ Return to the standard screen.



(10) Confirming the data.

▶ Confirm the data. Press the jog icons ( ) so the sewing machine movement can be confirmed.  
(Even if the data input has not been completed, if the data input last has been set, the movement can be confirmed in the same manner.)

▶ If the data must be modified, refer to “section [11]”.

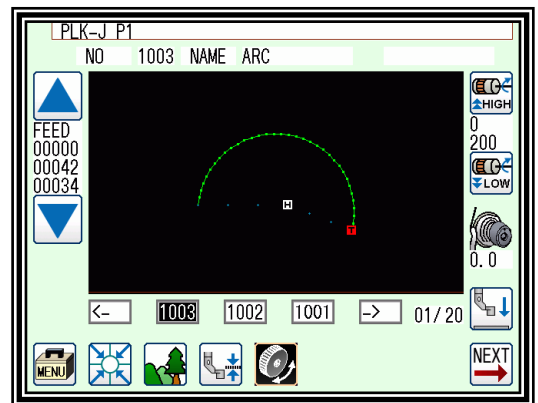

**Note** The size display of the pattern data is explained when "The arc" or "The Circle" is made and the image display is pushed from a standard screen,  the image display screen is opened.

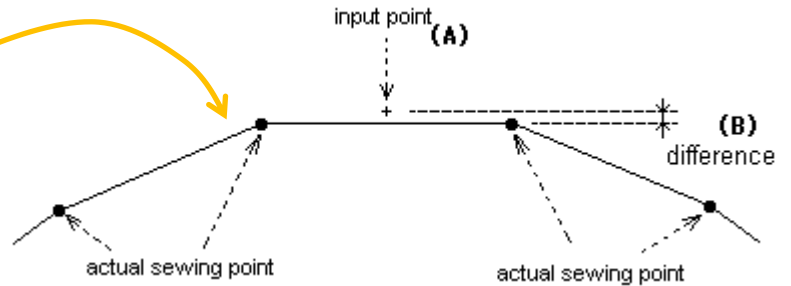
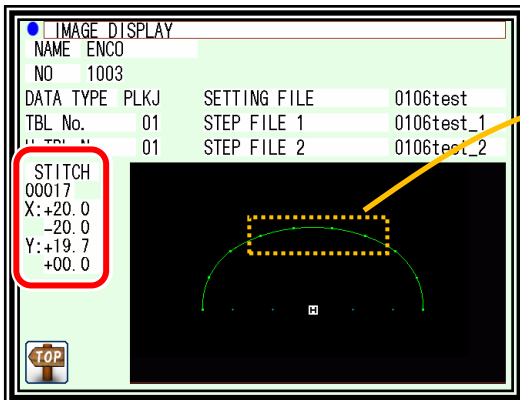

For instance, when made the 20mm half circle data but the size display is not [20.0] Y axially, is [19.7] it like the above figure.

The reason for this is that the displayed value is calculated with an actual sewing point. Tries to make the circle or the circular arc which passes input point as shown in the figure below, the data is made according to the specified stitch length, it is not match that sewing point and input point (A). There is difference (B) of the figure below because the value is calculated with the sewing point.



### 3. Circle input

#### Operation points

- Designate circle input
- Input three points (A circle, passing through the current position (already input) and two newly input points, is created.)



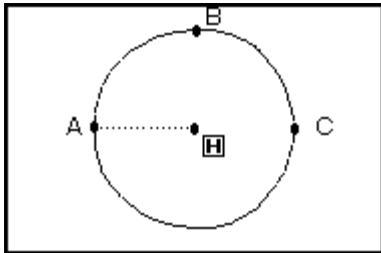

**Caution** Note that the work holder will go back to the circle start position after the data is created.

[Example] The following type of sewing data will be created.





#### Operation details

(1) Inputting feed data to A point.

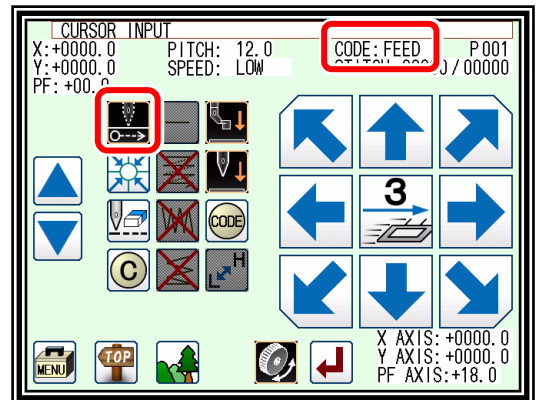
- ▶ Press  and  on the Standard screen. After making the various settings on the Data Setting Input screen, the Arrow Input screen will open. (Refer to page [6] - 4)
- ▶ Check that the code is set to FEED. If different code is set, press  and set the code to FEED.
- ▶ Press the arrow icons and move to the A point. (Feed data to A point.)



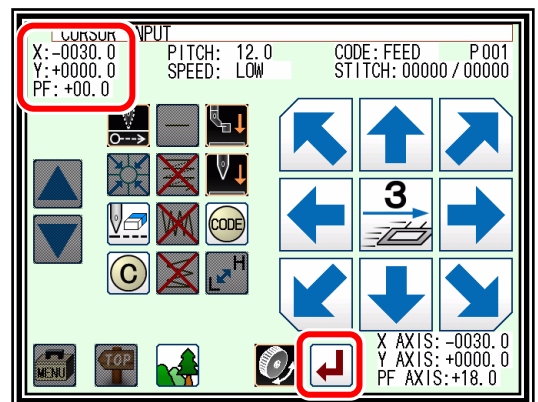

(2) Setting feed data to A point.

- ▶ The movement amount can be confirmed.
- ▶ Press  to set the data. (Data on feed data to point A will be created.)
- ▶ To change the stitching type to "Circle input", press the input method setting icon. (In this case, the  icon.)



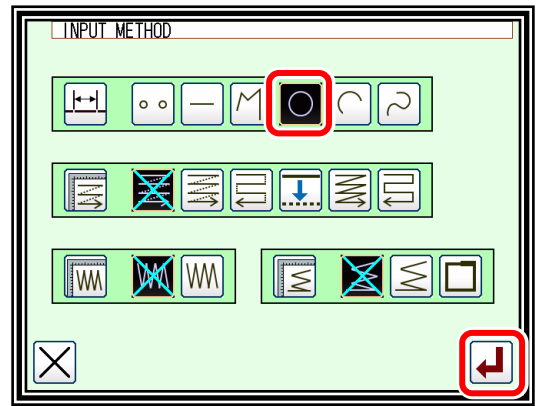

(3) Designating circle input.

- ▶ Press .
- ▶ Press  and set the data.
- ▶ The system will return to the arrow input screen.



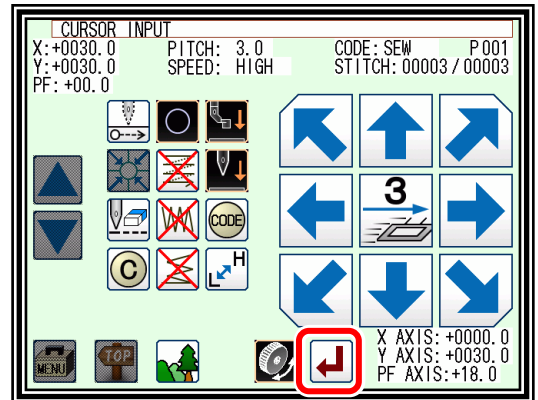

(4) Setting B point and C point.

- ▶ Using the arrow icons, move to the B point.
- Press  to determine point B.
- ▶ The Arrow Input screen will reappear, so press the arrow icons and move to the C point.
- Press  to determine point C.



(5) Creating the circle input data.

- ▶ The confirmation message "Create circle" will appear.
- ▶ Press  to return to the point C data entry panel.
- ▶ Press  and start creation of the circle input data.
- ▶ A message indicating that the data is being created will appear.

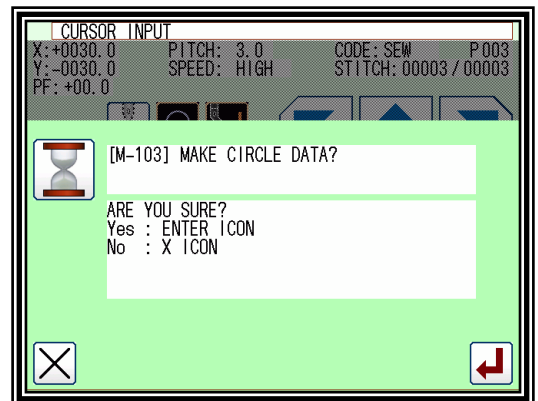

 **Caution** Note that the work holder will move to the current position after the data is created.

(6) Completing circle input.

- ▶ Press .

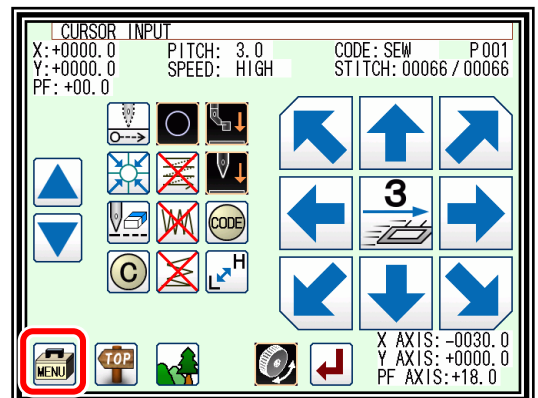



(7) Inputting the return/end code.

▶ Press  .

(Data on feed data to the home position and the end code will be created.)

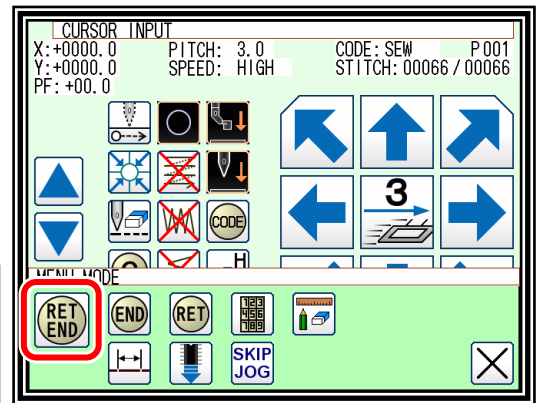
 **Caution** The work holder will automatically return to the home position. Take care when the needle is lowered, etc.



▶ A prompt for home position return will appear. Press  .

 **Caution** The needle will rise to the UP position. If the needle is not at the UP position, it may lower once and then return to the UP position.



(8) Select a saving method.

▶ After selecting the saving method, press  icon.  
(Refer to page [5] - 7.)

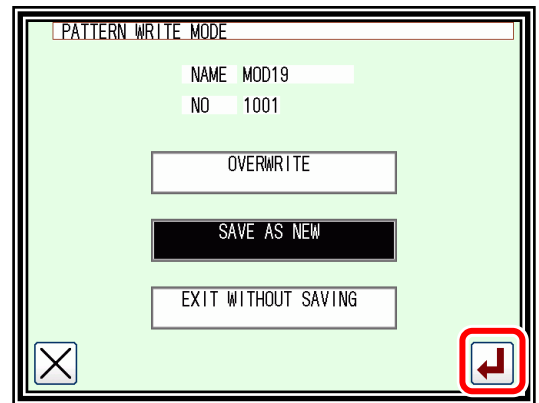
▶ Return to the standard screen.



(9) Confirming the data.

▶ Confirm the data. Press the jog icons ( ) so the sewing machine movement can be confirmed.  
(Even if the data input has not been completed, if the data input last has been set, the movement can be confirmed in the same manner.)

▶ If the data must be modified, refer to “section [11]”.

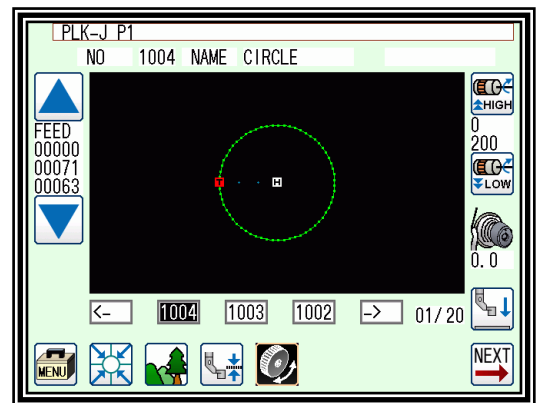

## 4. Curve input

### Operation points

- Designate curve input
- Up to 300 points can be input (A curve, passing through the current position and the input points, is created.)
- A delimiter point can be inserted at a pointed corner to continuously input the curve.

[Example] The following type of sewing data will be created.

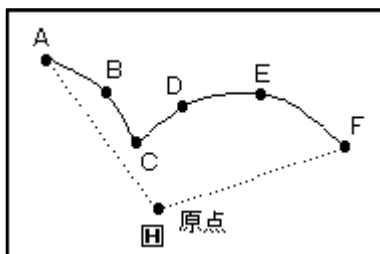



A delimiter is set at the C point.

[Note] Set the stitch length between 0.1 to 10.0mm.



### Operation details

(1) Inputting feed data to A point.

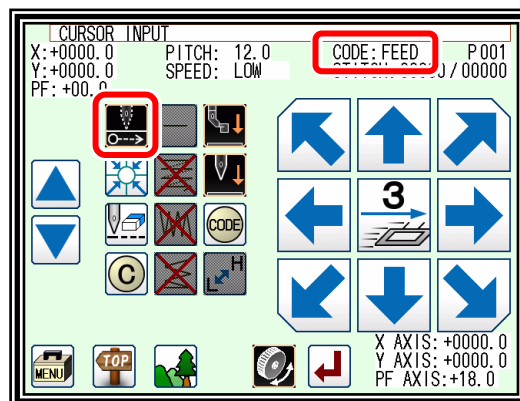
- ▶ Press  and  on the Standard screen. After making the various settings on the Data Setting Input screen, the Arrow Input screen will open. (Refer to p. page [6] - 4)
- ▶ Check that the code is set to FEED. If different code is set, press  and set the code to FEED.
- ▶ Press the arrow icons and move to the A point. (Feed data to A point.)



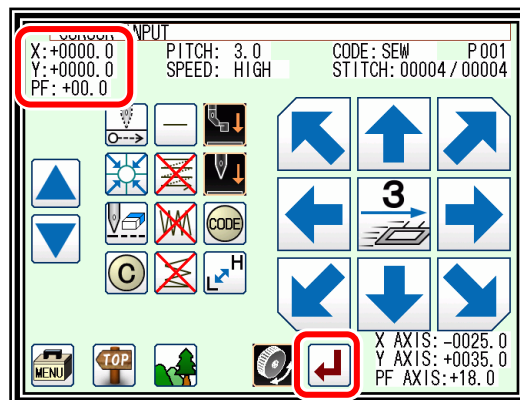

(2) Setting feed data to A point.

- ▶ The movement amount can be confirmed.
- ▶ Press  to set the data. (Data on feed data to point A will be created.)
- ▶ To change the stitching type to "CURVE INPUT", press the input method setting icon. (In this case, the  icon.)



(3) Designating curve input.

- ▶ Press .
- ▶ Press  and set the data.
- ▶ The system will return to the arrow input screen.

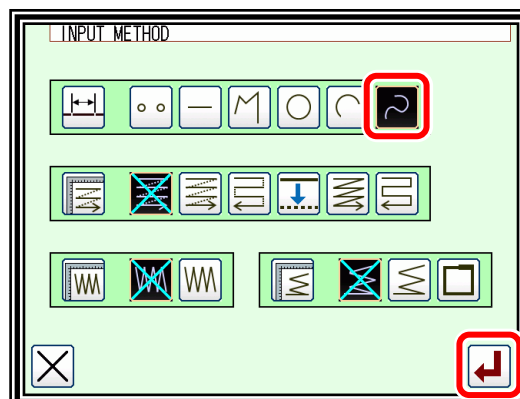

(4) Setting B point.

▶ Press the arrow mark icon to move to point B.

▶ Press  to determine point B.

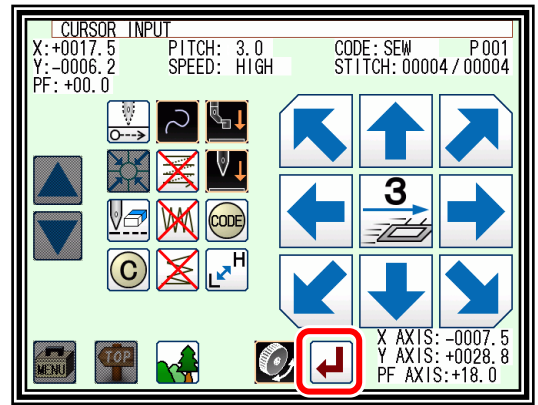

(5) Setting C point.

▶ Press the arrow mark icon to move to point C.

Press  to determine point C.

▶ Press  again to enter the breakpoint.

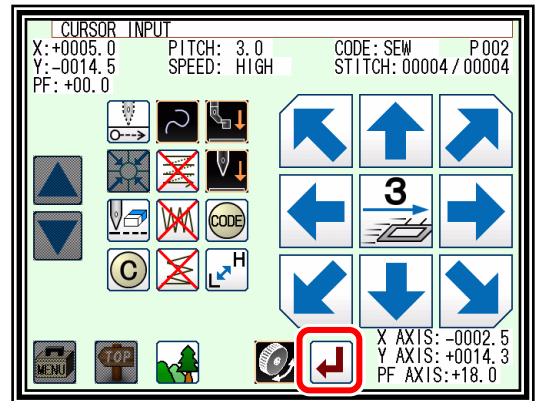

(6) Inserting a delimiter point.

▶ The data creation confirmation message "Create breakpoint data" will appear.

▶ Press  to return to the point C data entry screen.

▶ Press . The breakpoint will be set here.

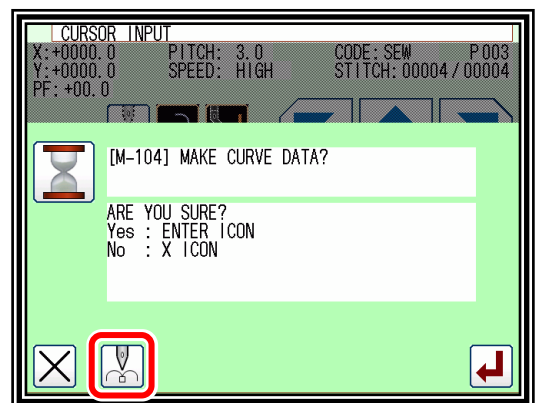

(7) Setting the D point, E point and F point, and setting the curve input.

▶ The Arrow Input screen will reappear.

▶ Press the arrow icons, and move to the D point.

Press  to determine point D.

▶ Press the arrow icons again, and move to the E point.

Press  to determine point E.

▶ Press the arrow icons again, and move to the F point.

Press  to determine point F.

(Up to 300 points can be input.)

▶ At the completion of all point data entry, press  again to create data.

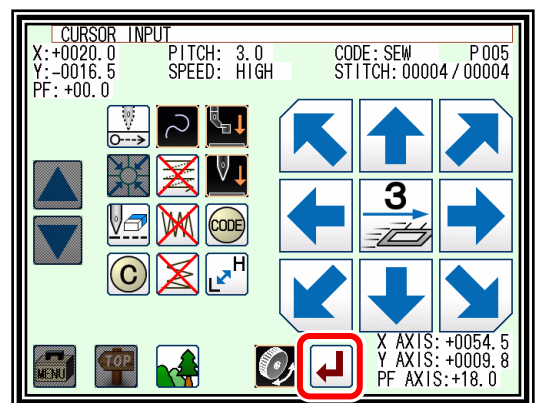

(8) Creating the curve input.

▶ The data creation confirmation message "Create breakpoint data" will appear.

▶ Press  to return to the last point input screen.

▶ Press  to start creation of the curve input data.

▶ A message indicating that the data is being created will appear.

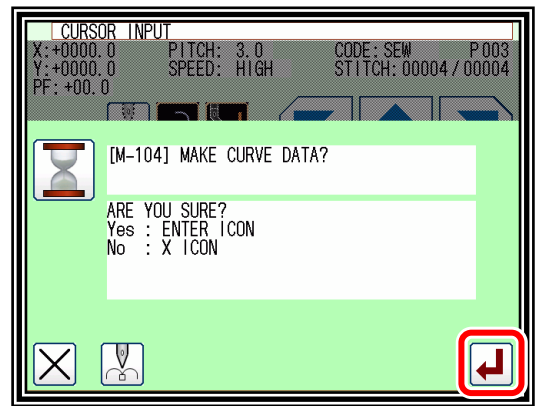

(9) Completing curve input creation.

▶ Press .

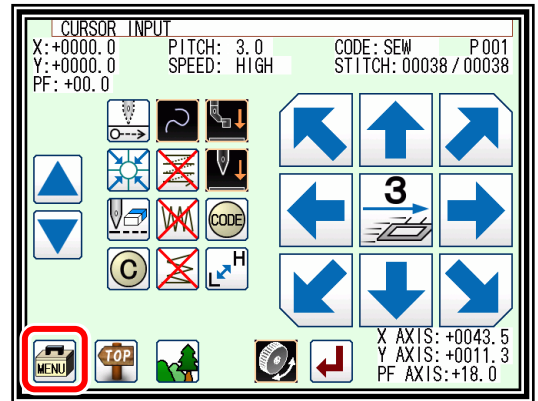



(10) Inputting the return/end code.

▶ Press .

(Data on feed data to the home position and the end code will be created.)

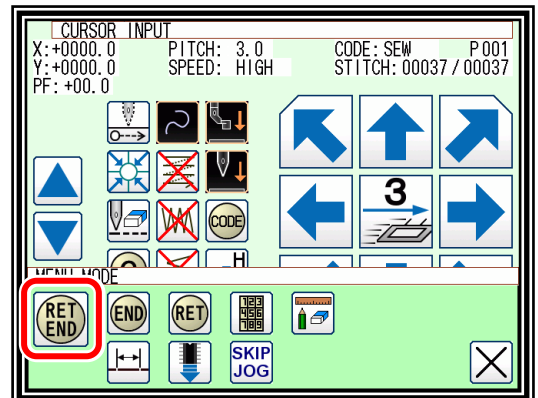
**Caution** The work holder will automatically return to the home position. Take care when the needle is lowered, etc.



▶ A prompt for home position return will appear. Press .

**Caution** The needle will rise to the UP position. If the needle is not at the UP position, it may lower once and then return to the UP position.

(11) Select a saving method.

▶ After selecting the saving method, press  icon.

(Refer to page [5] - 7.)

▶ Return to the standard screen.

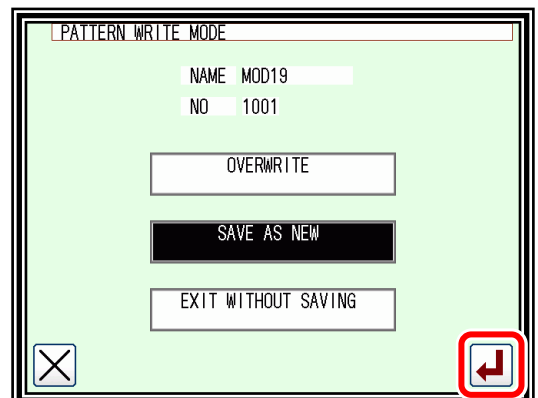

(12) Confirming the data.

- ▶ Confirm the data. Press the jog icons (▲ ▼) so the sewing machine movement can be confirmed.

(Even if the data input has not been completed, if the data input last has been set, the movement can be confirmed in the same manner.)

- ▶ If the data must be modified, refer to “section [11]”.

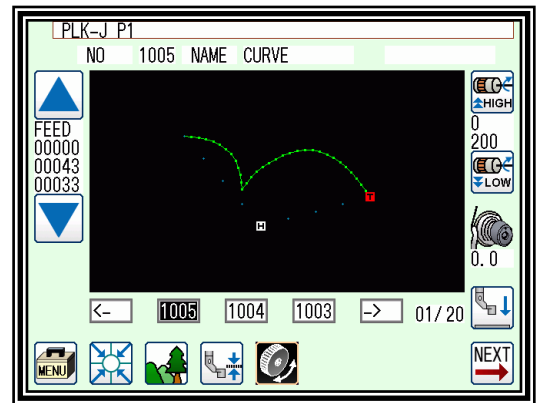

**Note** If the distance between the curve start point and the end point is less than 0.5 mm, the pattern will be regarded as the "closed pattern", and the same coordinate value will be automatically set for both the start point and end point.

Precautions for inputting a curve

- ▶ For shape data as shown below, continuous curve input is possible by selecting a delimiter point where the corner is pointed (K point).  
(This can also be applied for discontinuity points such as for offset stitching, multiple stitching, and reverse multiple stitching.)

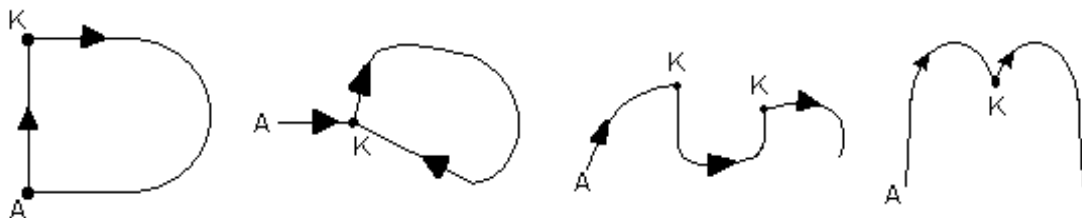

## 5. Broken line input

### Operation points

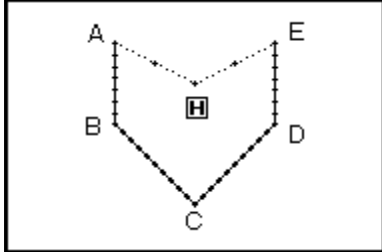

- Designate broken line input
- Up to 300 points can be input  
(A broken line connecting the current position and input points is created.)

[Example] The following type of sewing data will be created.





### Operation details

(1) Inputting feed data to A point.

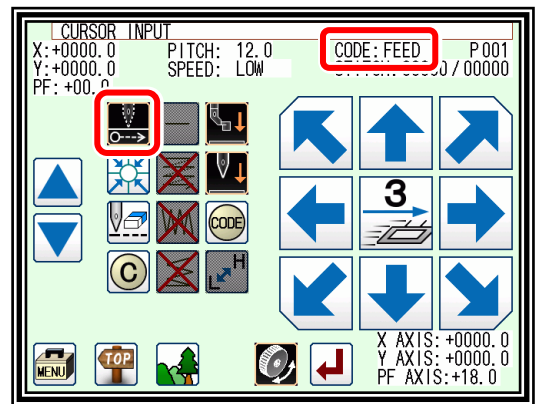
- ▶ Press  and  on the Standard screen. After making the various settings on the Data Setting Input screen, the Arrow Input screen will open. (Refer to page [6] - 4)
- ▶ Check that the code is set to FEED. If different code is set, press  and set the code to FEED.
- ▶ Press the arrow icons and move to the A point.  
(Feed data to A point.)



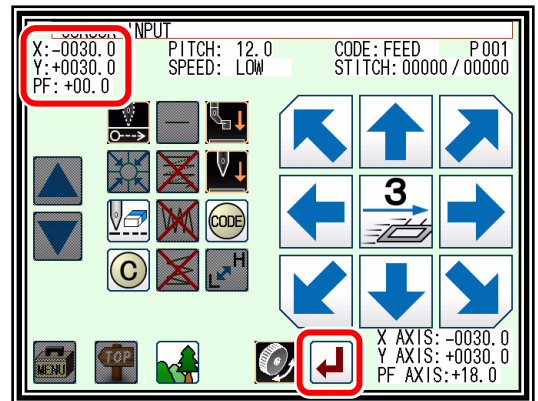

(2) Setting feed data to A point.

- ▶ The movement amount can be confirmed.
- ▶ Press  to set the data.  
(Data on feed data to point A will be created.)
- ▶ To change the stitching type to "Broken line input", press the input method setting icon.  
(In this case, the  icon.)



(3) Designating broken line input.

- ▶ Press .
- ▶ Press  and set the data.
- ▶ The system will return to the arrow input screen.

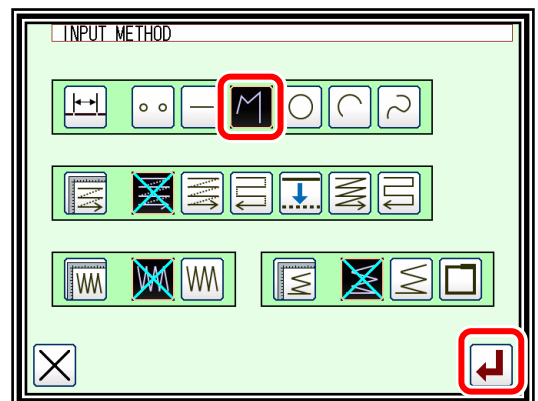



(4) Setting B point, C point, D point, E point.

- ▶ Press the arrow mark icon to move to point B.

Press  to determine point B.

- ▶ Press the arrow mark icon to move to point C.

Press  to determine point C.

- ▶ Press the arrow mark icon to move to point D.

Press  to determine point D.

- ▶ Press the arrow mark icon to move to point E.

Press  to determine point E. (Up to 300 points can be input.)

- ▶ At the completion of all point data entry, press  again to create data.

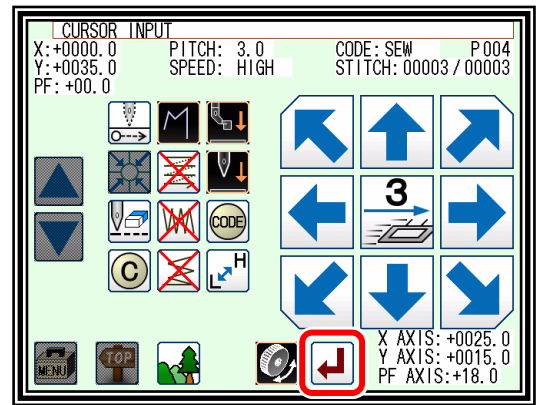

(5) Creating the broken line input.

- ▶ The data creation confirmation message "Create breakpoint data" will appear.

- ▶ Press  to return to end point input screen.

- ▶ Press  to start creation of the broken line input data. (The broken line will be created.)

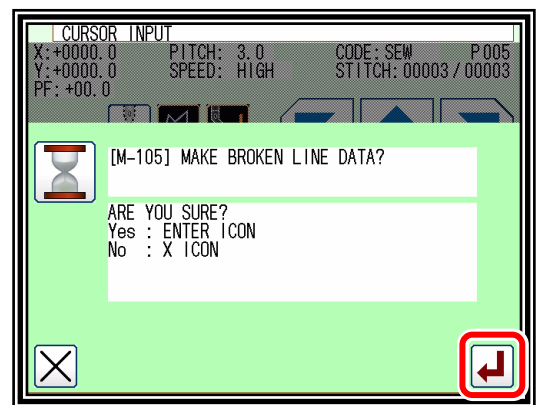

- ▶ A message indicating that the data is being created will appear.

(6) Creating the broken line input.

- ▶ Press  .

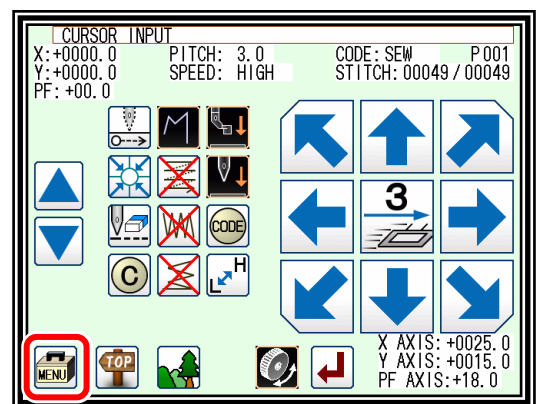



(7) Inputting the return/end code.

▶ Press .

(Data on feed data to the home position and the end code will be created.)

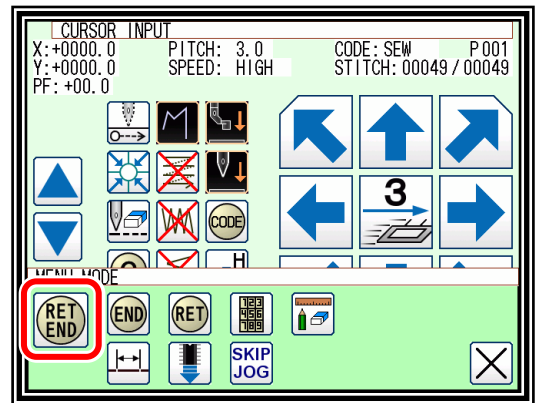
 **Caution** The work holder will automatically return to the home position. Take care when the needle is lowered, etc.



▶ A prompt for home position return will appear. Press .

 **Caution** The needle will rise to the UP position. If the needle is not at the UP position, it may lower once and then return to the UP position.



(8) Select a saving method.

▶ After selecting the saving method, press  icon.  
(Refer to page [5] - 7.)

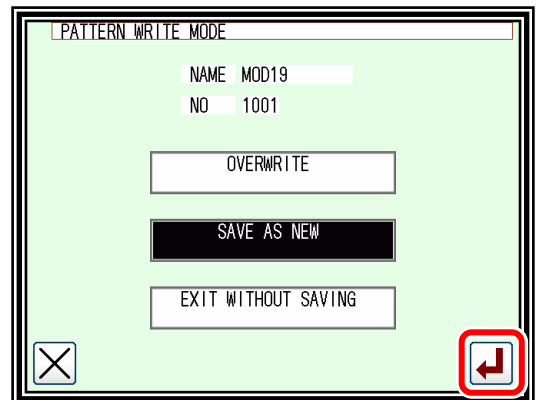
▶ Return to the standard screen.



(9) Confirming the data.

▶ Confirm the data. Press the jog icons (   )  
so the sewing machine movement can be confirmed.

(Even if the data input has not been completed, if the data input last has been set, the movement can be confirmed in the same manner.)

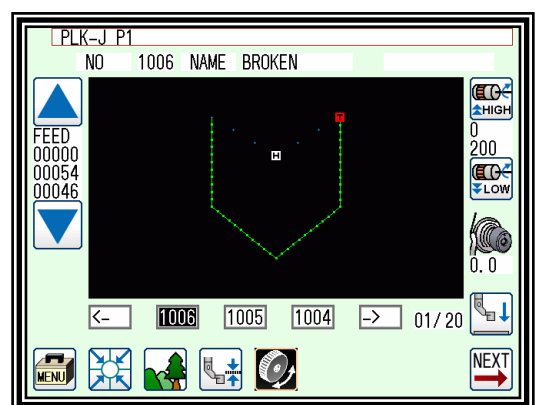

▶ If the data must be modified, refer to "section [11]".

**Note** If the distance between the broken line start point and the end point is less than 0.5 mm, the pattern will be regarded as the "closed pattern", and the same coordinate value will be automatically set for both the start point and end point.

## 6. Point input



### Operation points

- Designate point input
- The distance between the points must be within 20mm

[Example] The following type of sewing data will be created.

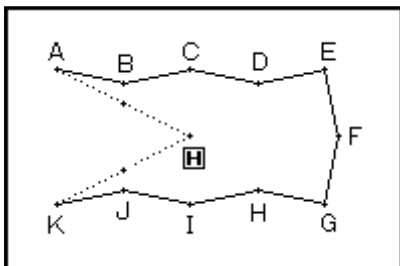

### Operation details

(1) Inputting feed data to A point.

- ▶ Press and on the Standard screen. After making the various settings on the Data Setting Input screen, the Arrow Input screen will open. (Refer to page [6] - 4)
- ▶ Check that the code is set to FEED. If different code is set, press and set the code to FEED.
- ▶ Press the arrow icons and move to the A point. (Feed data to A point.)

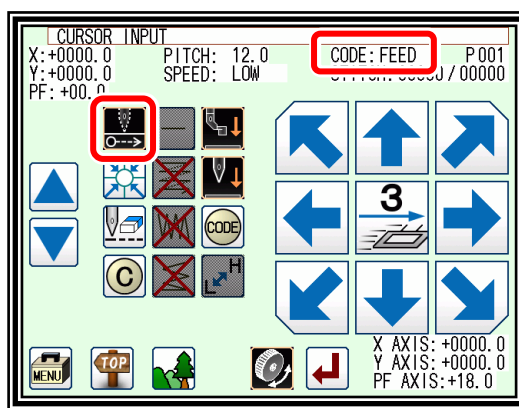

(2) Setting feed data to A point.

- ▶ The movement amount can be confirmed.
- ▶ Press to set the data. (Data on feed data to point A will be created.)
- ▶ To change the stitching type to "POINT INPUT", press the input method setting icon. (In this case, the icon.)

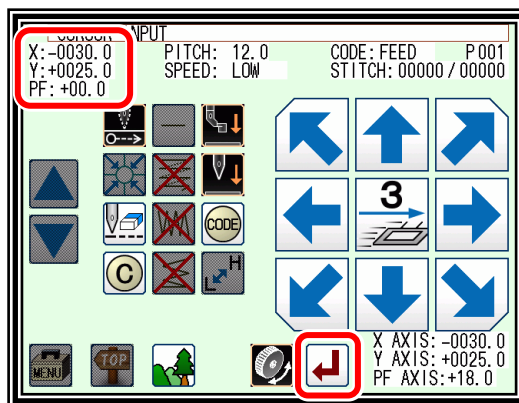

(3) Designating point input.

- ▶ Press .
- ▶ Press and set the data.
- ▶ The system will return to the arrow input screen.

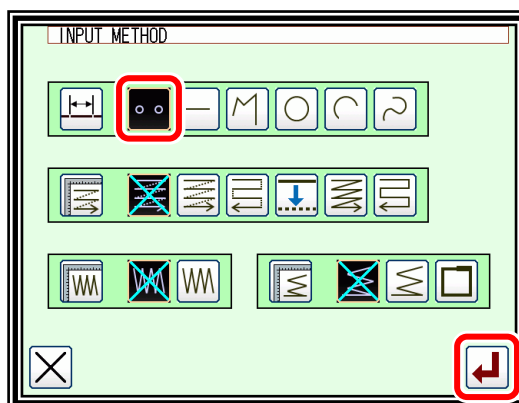

(4) Setting B point to K point.

- ▶ Press the arrow mark icon to move to point B.

Press  to determine point B.

**Note** The distance between the points must be within 20mm.

- ▶ Press the arrow mark icon to move to point C.

Press  to determine point C.

- ▶ The Arrow Input screen will reappear, so press the arrow icons and move to the D point to K point in the same manner.

- ▶ Press .

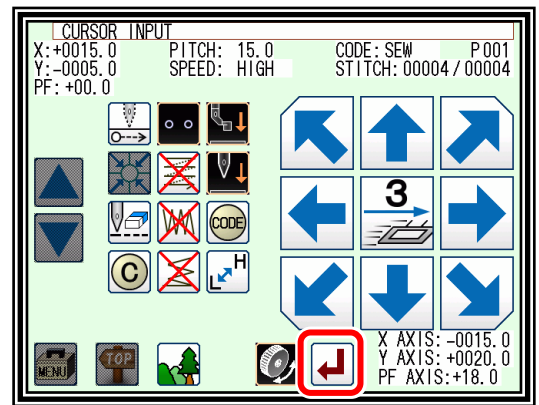



(5) Inputting the return/end code.

- ▶ Press .

(Data on feed data to the home position and the end code will be created.)

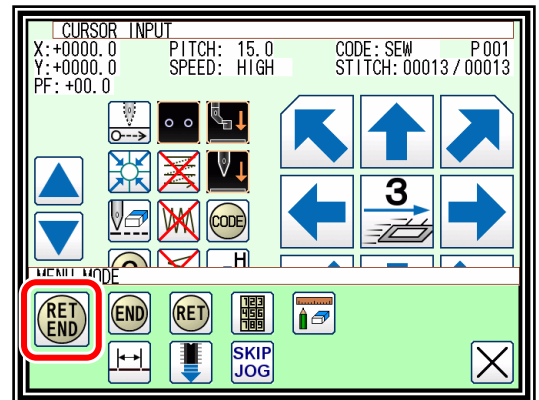
**Caution** The work holder will automatically return to the home position. Take care when the needle is lowered, etc.



- ▶ A prompt for home position return will appear. Press .

**Caution** The needle will rise to the UP position. If the needle is not at the UP position, it may lower once and then return to the UP position.



(6) Select a saving method.

- ▶ After selecting the saving method, press  icon.  
(Refer to page [5] - 7.)

- ▶ Return to the standard screen.



(7) Confirming the data.

- ▶ Confirm the data. Press the jog icons (   ) so the sewing machine movement can be confirmed.

(Even if the data input has not been completed, if the data input last has been set, the movement can be confirmed in the same manner.)

- ▶ If the data must be modified, refer to “section [11]”.

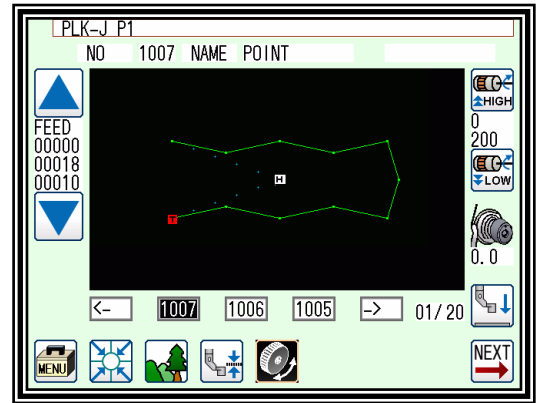

## 7. Code data input



### Operation points

- Designate code data input
- Select and input the code data from the code data list

[Example] The following type of sewing data will be created.

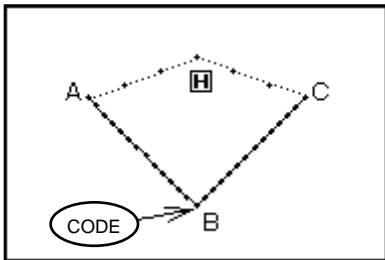

Input the "NEEDLE UP HALT" code at the B point between the A-B point linear line and B-C linear line.

[Memo] Code data cannot be inserted when inputting with a linear, circle, arc, curve or polygonal line. To input, add the code data with the modification mode. (Input between the linear lines is possible as shown in the example.)

### Operation details

(1) Inputting a linear line from A point to B point.

- ▶ Input a linear line from the A point to B point using the linear input procedures.

(2) Inputting the code data. (NEEDLE UP HALT)

- ▶ Press .

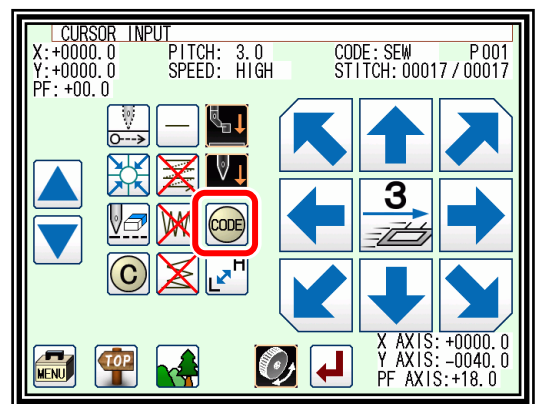

- ▶ Press .  
(Refer to the code list of the next page.)

- ▶ Press to set the code.  
(The "NEEDLE UP HALT" code will be created.)

- ▶ The system will return to the arrow input screen.

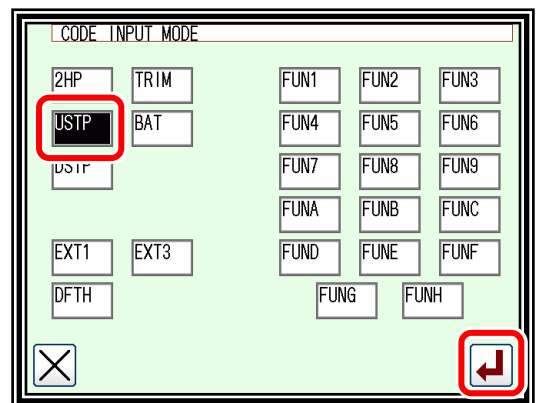

(3) Inputting a linear line from B point to C point.

- ▶ Input a linear line from the B point to C point using the linear input procedures.

(4) Inputting the return end and the data completion.

- ▶ The return end is input and it is completion.

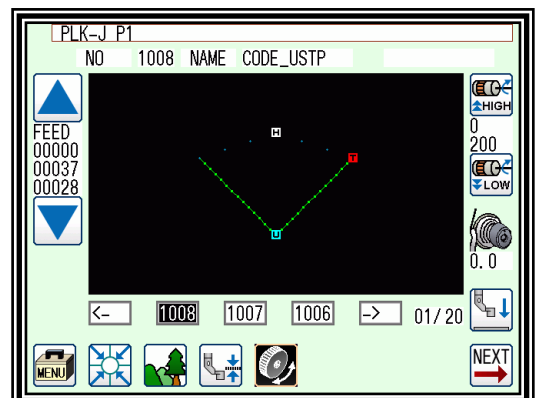

■ List of code data

Code	Function	Code	Function
2HP	2nd home position	FUN1	Function code 1
USTP	Needle UP halt	FUN2	Function code 2
DSTP	Needle DOWN halt	FUN3	Function code 3
TRIM	Thread trimming	FUN4	Function code 4
BAT	Basting	FUN5	Function code 5
<div style="border: 1px solid black; padding: 2px; margin-bottom: 5px;">EXT1 : Extension code</div> ASRT : Automatic start after stopping		FUN6	Function code 6
		FUN7	Function code 7
		FUN8	Function code 8
		FUN9	Function code 9
		FUNA	Function code A
		FUNB	Function code B
		FUNC	Function code C
		FUND	Function code D
		FUNE	Function code E
		FUNF	Function code F
		FUNG	Function code G
		FUNH	Function code H
		<div style="border: 1px solid black; padding: 2px; margin-bottom: 5px;">EXT3 : Extension code</div> F1_H to FH_H : FN (1 to H) Output ON F1_L to FH_L : FN (1 to H) Output OFF	
<div style="border: 1px solid black; padding: 2px; margin-bottom: 5px;">EXT2 : Extension code</div> DFTH : Detecting material thickness setting			

Making method of using BAT (Basting or more than 20mm stitch length) code.

The sewing data which exceeds the stitch length limitation of 20mm can be made by using this BAT code.

[Example] The following type of sewing data will be created.

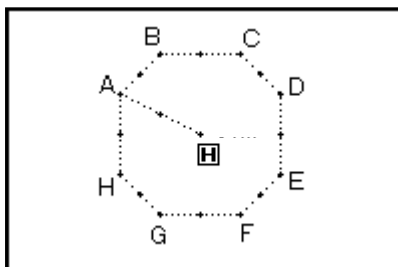

(1) Input the "BAT" codes after input the feed data to A point.

► Press  .

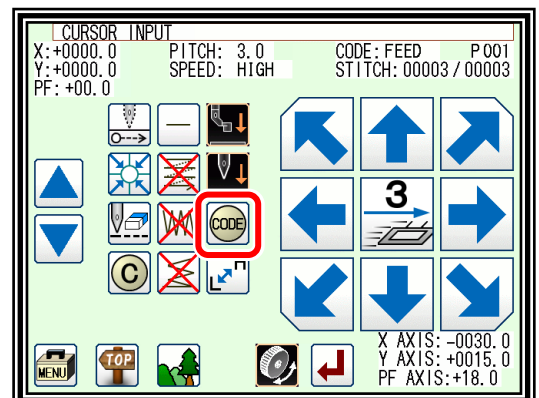

(2) Code selection on code selection screen.

- ▶ Press **BAT**.
- ▶ Press  to set the code.  
(The BAT code is made.)
- ▶ Returns to the arrow input screen.

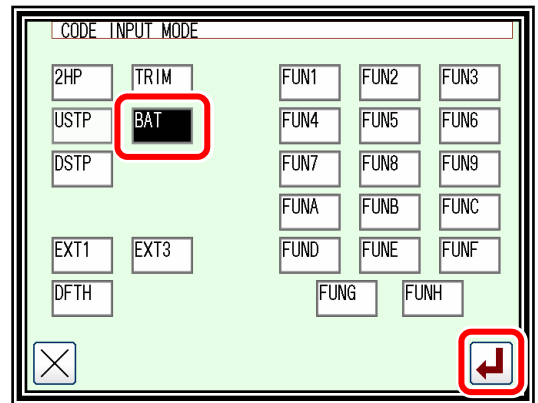

(3) Arrow input screen.

- ▶ Does not become SEW (Sewing) input mode and it is FEED input mood after input the "BAT" code.
- ▶ Input the feed data to the next B point.
- ▶ Input the "BAT" code and the feed data from H point to A point repeating.

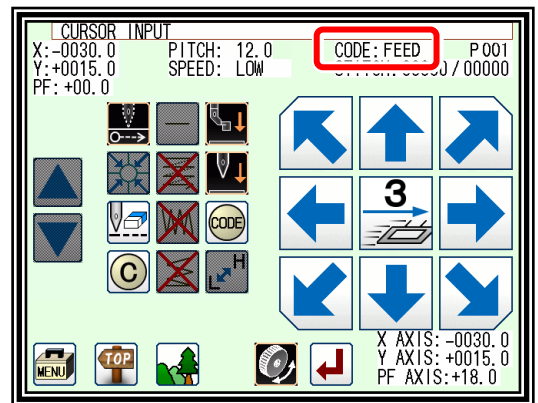

(4) The pattern data input before return end.

- ▶ It is not input the "BAT" code before the last of return end but the sewing data is input. Inputs here only by 1 stitch of the straight line.

**Note** The purpose of inputting the sewing data at the end is to put the thread trimmer (TRIM) code by the automatic operation when the return end is input. The thread trimmer (TRIM) code cannot be input after the sewing data.

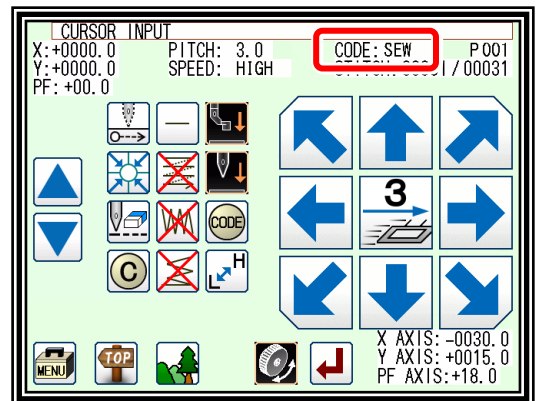

(5) Input the return end and the data completion.

- ▶ The return end is input and it is completion.

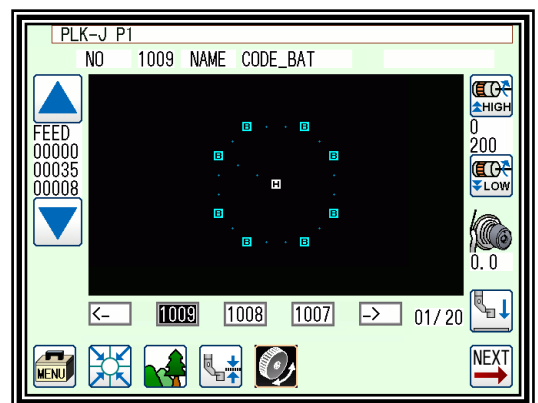



## About Extension code 1 (EXT1)

Press the Extension screen display key **EXT1**,  
and press .

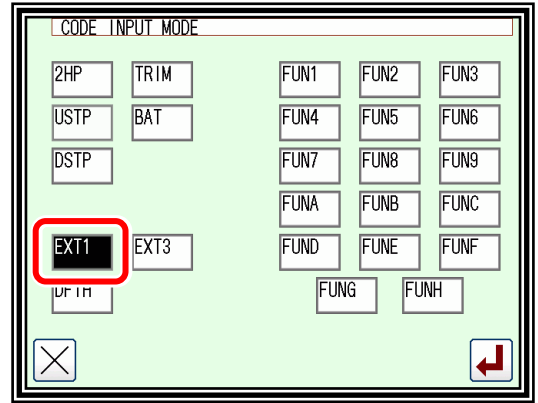

► "ASRT" : Automatic start after stopping  
using the numeric keypad, set the time that stops  
until starting automatically.

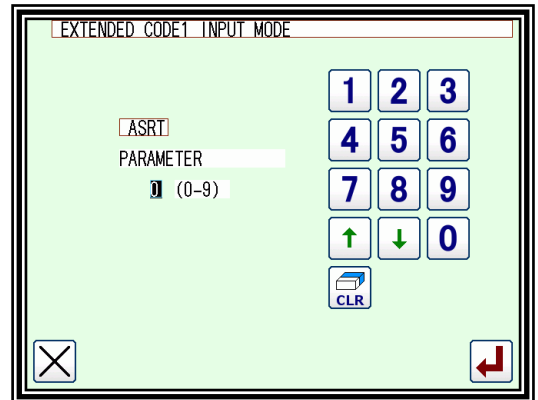



## About the Function code (FUN1 to FUNH)

Output signal FN1 to FNH can be controlled by set in the pattern data. (Refer to page [15] - 9)

When code data FUN1 is read in the pattern data while sewing, FN1 output is reversed.  
(same as FUN2 to FUNH)

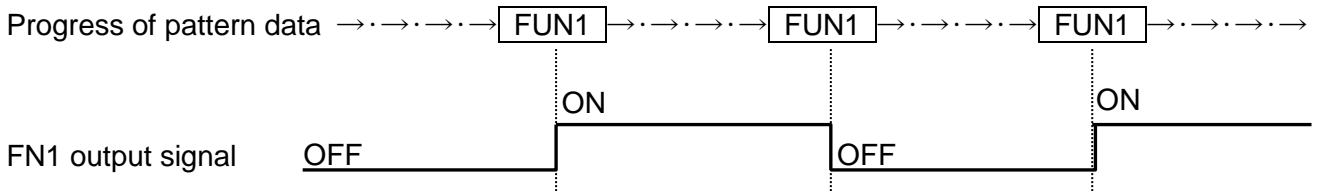
[example. Timing chart when FUN1 code is set in the pattern data]



 **Caution** PLEASE DO NOT MIX F1\_H to FH\_H or F1\_L to FH\_L code  
with FUN1 to FUNH code in the same data.

## About Extension code 3 (EXT3)

‡ Press the Extension screen display key [EXT3], and press .

These signal also controls output signal FN1 to FNH as well as above mentioned extension code.

(FUN1 to FUNH). (Refer to page [15] - 9)

When code data F1\_H is read in the pattern data while sewing, FN1 output is turned on.

When code data F1\_L is read in the pattern data while sewing, FN1 output is turned off.

(Same as F2\_H to FH\_H, F2\_L to FH\_L)

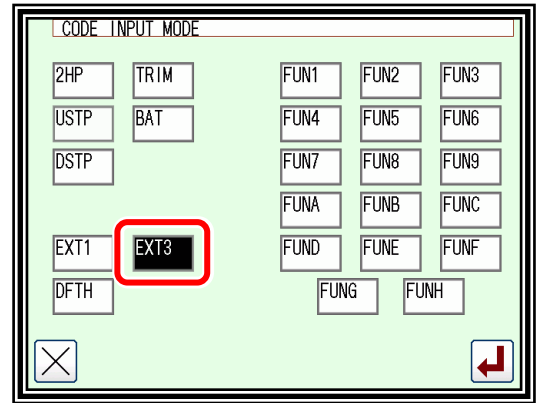

 **Caution** PLEASE DO NOT USE [F1\_H] CODE REPEATEDLY AFTER THE SAME CODE. PLEASE DO NOT USE [F1\_L] CODE REPEATEDLY AFTER THE SAME CODE. PLEASE USE [F1\_H] CODE AND [F1\_L] CODE ALTERNATELY. (Also F2\_H to FH\_H, F2\_L to FH\_L)

 **Caution** [F1\_L] CODE MUST BE INPUTTED AFTER [F1\_H] CODE IS ALREADY INPUTTED.(Also F2\_H to FH\_H, F2\_L to FH\_L)

 **Caution** PLEASE DO NOT MIX FUN1 to FUNH code with F1\_H to FH\_H or F1\_L to FH\_L code in the same data.

[example. Timing chart when F1\_H/F1\_L code is set into the pattern data]

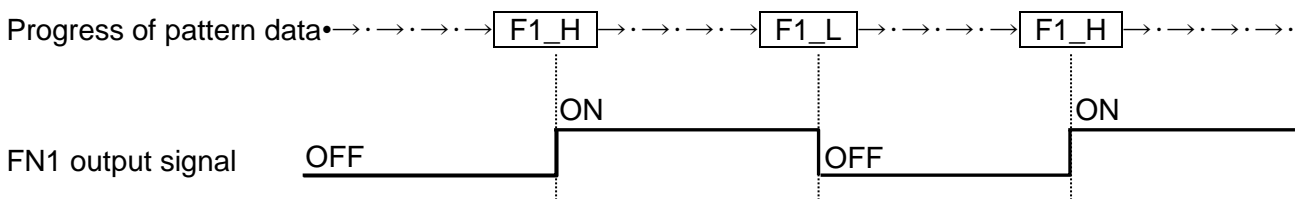

### [Example of prohibition]



[Same code repetition] • → • → • → • → [F1\_H] → • → • → • → [F1\_H] → • → • → • →

[Start from off code] • → • → • → • → [F1\_L] → • → • → • → [F1\_H] → • → • → • →

[Mixed use] • → • → • → • → [F1\_H] → • → • → • → [FUN1] → • → • → • →

## About Extension code 2 (DFTH)

Select the DFTH display key on the code input screen and press  to display the DFTH input screen.

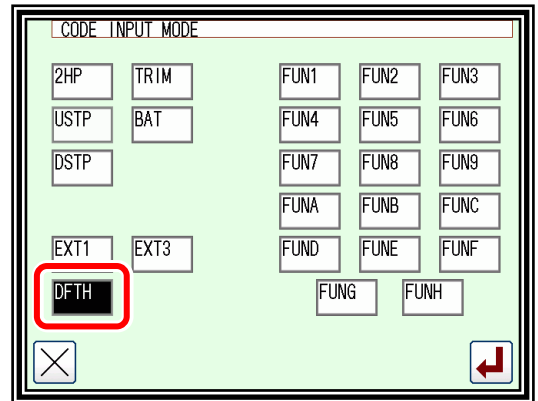

Set the thickness to be detected.  
For details, refer to “section [12]”.

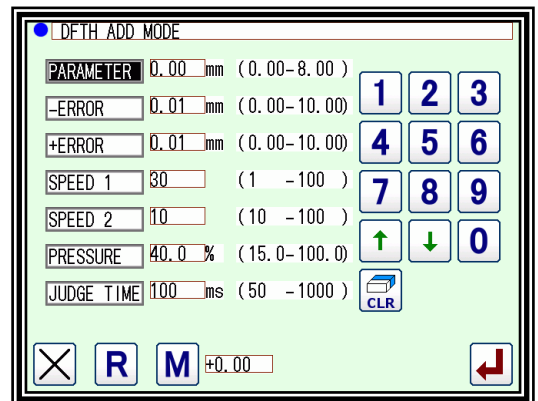





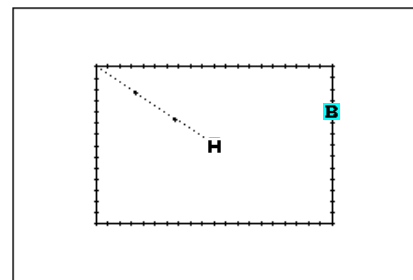



Confirming on the image screen (in the case of code input)

- T** : Thread Trimming (TRIM)
- U** : Needle UP Halt (USTP)
- D** : Needle DOWN Halt (DSTP)
- B** : Basting (BAT)
- F** : Function code, Extension code 3 (FUN, FN)
- O** : Extension code 1 or code 2 (ASRT, DFTH)



## Application inputs

Various types of stitching, including back tacking, multiple stitching, offset stitching and zigzag stitching can be carried out. Various types of stitching data can be created by combining the basic inputs and these types. (Refer to “section [9]”.) Note that the application inputs cannot be combined with point inputs to input data.

Function	icon	
Back tacking (page [7]-26)	 Start/end back tacking	
	 Overlap back tacking	
Multiple stitching (page [7]-30)	 Multiple stitching (Feed data specifications)	 Multiple stitching (stitching specifications)
	 Reverse multiple stitching (Feed data specifications)	 Reverse multiple stitching (stitching specifications)
Offset stitching (page [7]-33)		
Zigzag stitching (page [7]-35)		

## 8. Back tacking (start/end back tacking)

[Example] The following type of sewing data will be created.

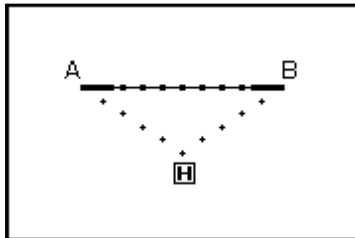



With the linear input, the N mode and 3-stitch back tacking will be inserted for both the start and end of stitching.  
(The bold sections indicate start/end back tacking.)

### Operation details

(1) Setting the input method.

▶ Set the feed data from the home position to the A point with the procedures for linear input, and open the Input Method Setting screen.

▶ Press Linear Input .

▶ Press back tacking .

▶ Press the back tacking details setting icon .

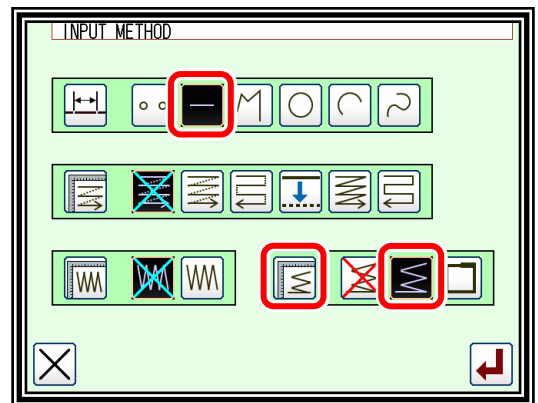



(2) Setting the back tacking details.

► The details are set on this screen.

(The details set here are,  (start/end back tacking),

start mode  (N mode), three start stitches,

end mode  (N mode), three end stitches.)

► Press  to determine these set values.

The system will return to the input method setting screen.

► Press  to determine the set values.

The system will return to the arrow input screen.

Determine the B point with the linear input procedures, and create a linear line.

► After creating the linear line, press .

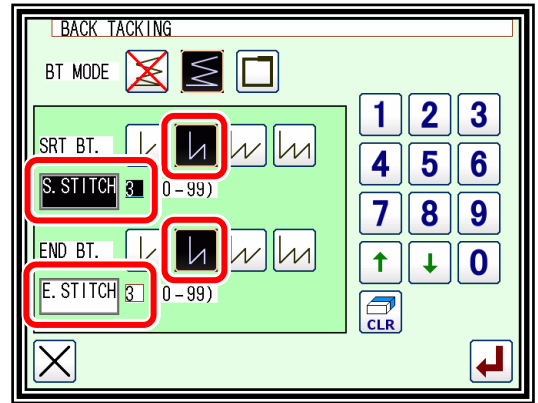

(3) Confirming the data.

► The start/end back tacking data for the linear line has been created.

**Note** Regarding back tacking mode

 V mode: Back tacking will be performed only once.

 N mode: Back tacking will be performed twice.

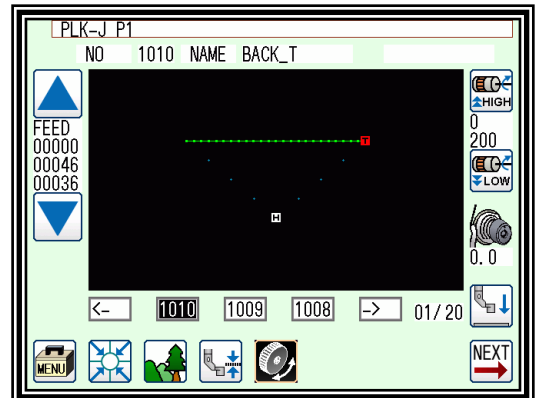

 M mode: Back tacking will be performed third.

 W mode: Back tacking will be performed fourth.



**Note** Regarding number of stitches.

Press the icon of the desired position (  or  ) to invert the icon.

After that, set data using the numeric icons or  .

**Note** Press the back tacking data setting icon on the arrow input screen to directly display the "detailed back tacking data setting" screen.

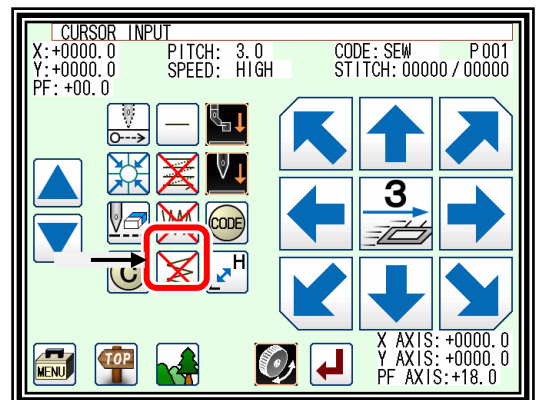

## 9. Back tacking (overlap back tacking)

[Example] The following type of sewing data will be created.

Input a rectangle as a broken line, and then insert overlap back tacking at the end. (The overlap mode is entered once; three overlap stitches are made.) (The bold section is the overlap back tacking section.)

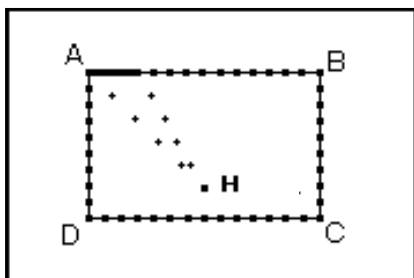

**Note** It is a shutting figure in the figure made in [Broken line], [Circle], [Curve] to be able to do multiple back tacking.

That is, it is not possible to do by combining "Straight line" in the plural in the enclosed figure.

Moreover, it is not possible to do by plural combining "Straight line" and "Curve" also even in the enclosed figure. The multiple back tacking can be made only by 1 place per 1 "Sewing" data origination.

### Operation details

#### (1) Setting the input method.

▶ Set the feed data from the home position to the A point with the procedures for broken line input, and open the Input Method Setting screen.

▶ Press broken Line Input .

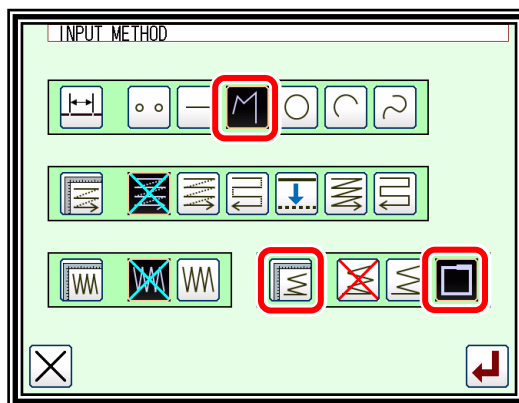

▶ Press Overlap back tacking .

▶ Press the back tacking details setting icon .



#### (2) Setting the back tacking details.

▶ The details are set on this screen.

(The details set here are, , (overlap back tacking), overlap mode , three overlap stitches.)

▶ Press  to determine these set values.

The system will return to the input method setting screen.

▶ Press  to determine the set values.

The system will return to the arrow input screen.

Determine the B, C, D and A points with the broken line procedures, and create the broken line data. (A broken line having overlap back tacking will be created.)

▶ After creating the broken line data input .

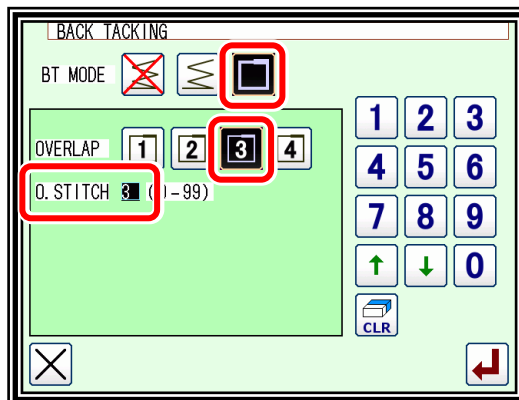

(3) Confirming the data.

- ▶ The overlap back tacking will be created with the rectangle made with broken lines.

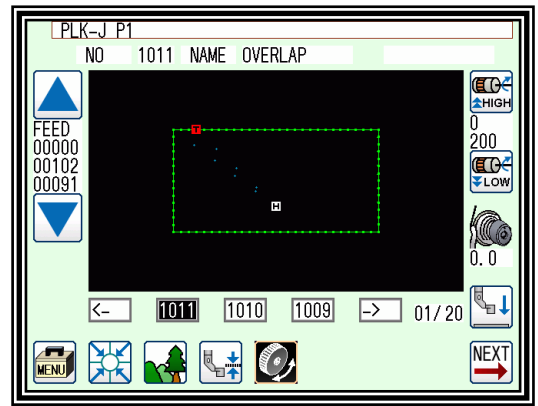

**Note** Overlap mode.

**1** **2** **3** **4** in the overlap mode indicate the number of overlapped sections.



**Note** Number of overlap stitches.

This is the number of stitches at the overlapped section. (Set a value between 0 and 99.)

**Note** If the distance between the broken line start point and the end point is 0.5 mm or more, the overlap back tacking data will not be created. (If the distance between the broken line start point and the end point is less than 0.5, the pattern will be regarded as the "closed pattern", and the same coordinate value will be automatically set for both the start point and end point.)

# 10. Multiple stitching

Type	Connection	icon	Stitching data image	Explanation
Multiple	Feed data			"Stitching" in a set direction is connected with "feed without stitching".
	Stitching			"Stitching" in a set direction is connected with "stitching".
Reverse multiple	Feed data600			"Stitching" in alternating reverse directions is connected with "feed data".
	Stitching			"Stitching" in alternating reverse directions is connected with "stitching".

 and  (dotted line) in the image indicates "feed data".  
 and  (solid line) in the image indicates "stitching".

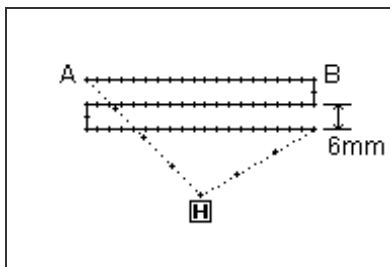

[Example] The following type of sewing data will be created.



Create the linear reverse multiple (stitching specification) data.  
 (The multiple distance is 6mm, the number of times is three, the direction is right.)

## Operation details

(1) Setting the input method.

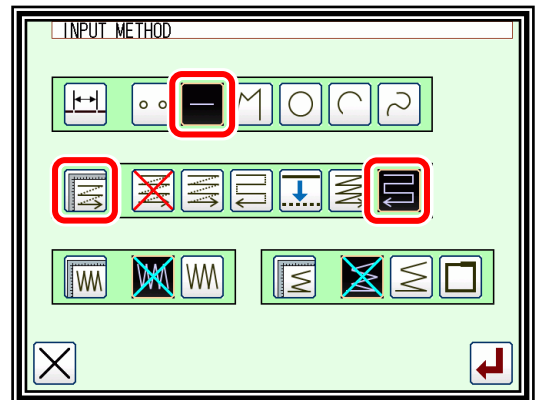

- ▶ Set the feed data from the home position to the A point with the procedures for linear input, and open the Input Method Setting screen.
- ▶ Press Linear input .
- ▶ Press reverse multiple (stitching specifications) .
- ▶ Press the reverse multiple details. Press .





(2) Setting the reverse multiple stitching details

► The details are set on this screen.

(Press  and , and set the distance to 6.0, and the number of times to 3.)

► Press  to set the data.

The system will return to the input method setting screen.

► Press  to set the data.

The system will return to the arrow input screen.

Determine the B point with the linear input procedures, and create a linear line. (A straight line having reverse multiple (stitching specification) will be created.)

► After creating the linear line, input .

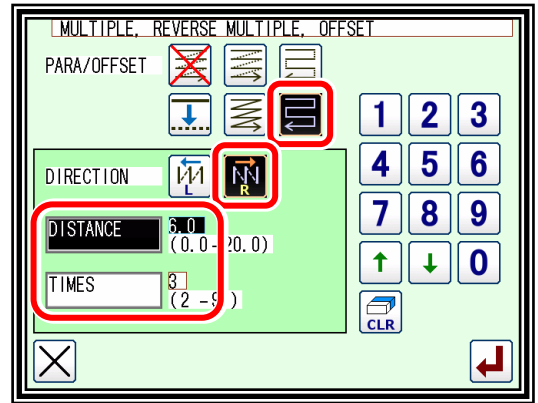

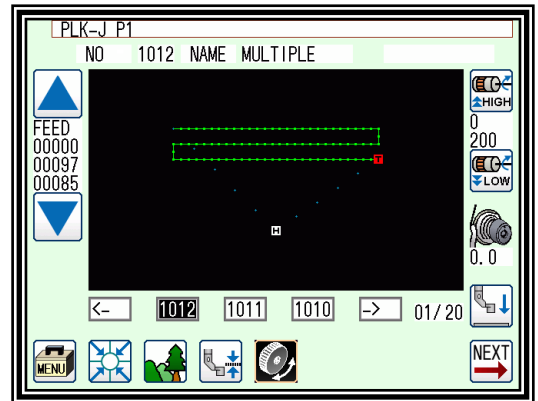

(3) Confirming the data

► Linear reverse multiple data has been created.



**Note** Direction

When creating multiple stitching to the left of the input stitching line, press  (left side).

When creating multiple stitching to the right of the input stitching line, press  (right side).

**Note** Distance

This is the distance between the multiple stitching and adjacent line. Set between 0.0mm and 20.0mm. To input the distance data, press the DISTANCE icon to invert the icon. After that, input the data using the numeric icons or the up/down arrow mark icons.

**Note** Number of times

Set the number of multiple stitching layers. Set between 2 and 9. To input the number of times, press the NUMBER OF TIMES icon to invert the icon. After that, input the data using the numeric icons or the up/down arrow mark icons.

**Note** Or press the MULTI, REVERSE MULTI, OFFSET icon on the arrow input screen to directly display the MULTI, REVERSE MULTI, OFFSET setting screen.

**Note** (A) It is for the combination data of a curve input and multiple (offset) sew.

The data like the figure below (right) is made as shown in the figure below (left) when curves which pass point 2, point 3, and point 4 after an feed from the home position to point 1 are combined with multiple sewing and inputs. (Distance = 10mm and 2 times of "Frequency")  
 The distance of the multiple data becomes "It is narrow" the data as shown in figure.

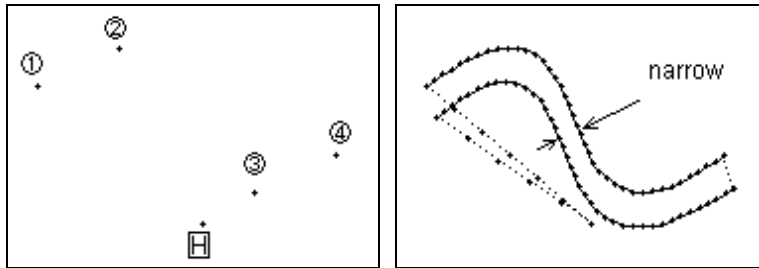

They are not like to make this partially narrow multiple data, to make a constant distance multiple data as much as possible, please input 2' between 2 and 3 as shown in the figure below (left). The multiple data as shown in the figure below (right) is made.

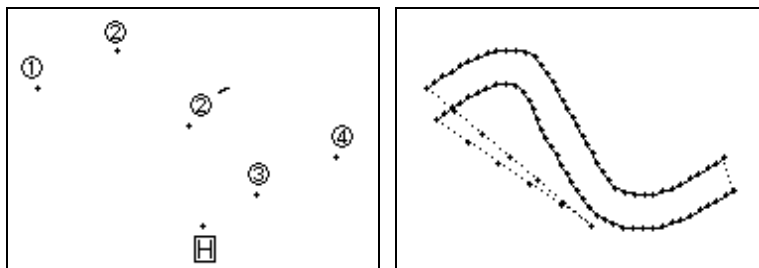

**Note** (B) It is for the combination data of a curve input (Broken line input) and multiple sew.

The data like the figure below (right) is made as shown in the figure below (left) when curves which pass point 2, point 3, and point 4 after an feed from the home position to point 1 are combined with multiple sewing and inputs. (Distance = 8mm and 4 times of "Frequency")

The data is made in the curve that the fourth curve is different as understood from figure (right).

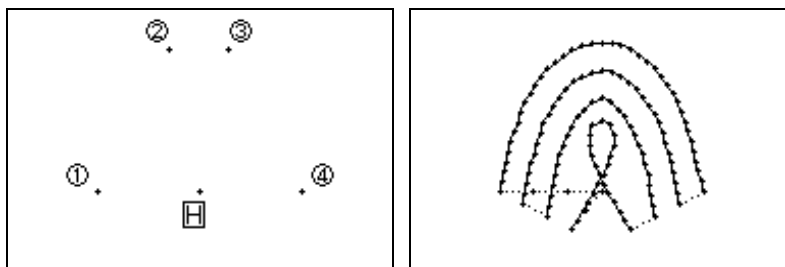

When the virtual input point which makes the multiple is requested by the operation, such a situation like the figure below, the reason for it is to intersect in the multiple.

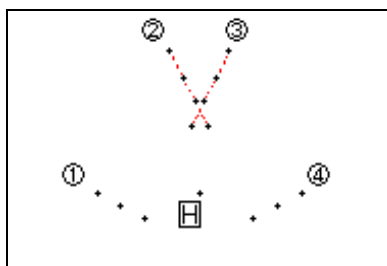

Moreover, such a situation changes variously depending on the condition of the input point etc. of "Distance", "Frequency" of the multiple data, and the curve.  
 Please use a variety of trying.

# 11. Offset stitching (with overlap back tacking)





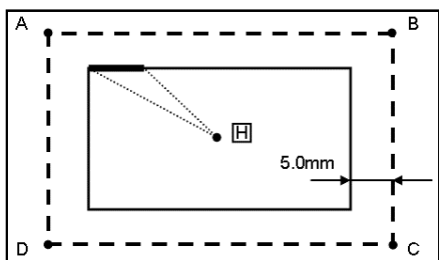

[Example] The following type of sewing data will be created.



Input offset stitching with overlap back tacking as a broken line. (Set the offset distance to "5.0 mm", direction to "right", overlap back tacking mode to "1", and number of stitches to "3".)  
 (The bold section indicates the overlap back tacking section.)  
 (The dotted line (- - - - -) indicates the actual input line (position before offset.))



## Operation details

### (1) Setting the input method.

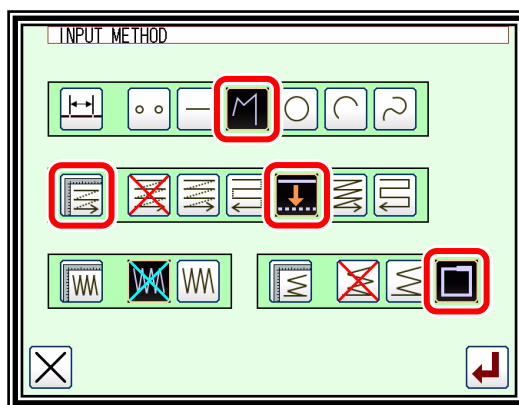
- ▶ Set the feed data from the home position H to the A point with the procedures for broken line input, and open the Input Method Setting screen.
- ▶ Press Broken Line input  .
- ▶ Press Offset  .
- ▶ Press Overlap Back Tacking  .
- ▶ Set the application input details. Press  .



### (2) Setting the offset details.

- ▶ The details are set on this screen.  
 (Press  , and set the distance to 5.0.)  
 ‡ The offset amount can be set in 0.1mm increments between 0 and 20mm.
- ▶ After inputting the details, press  to set the data.

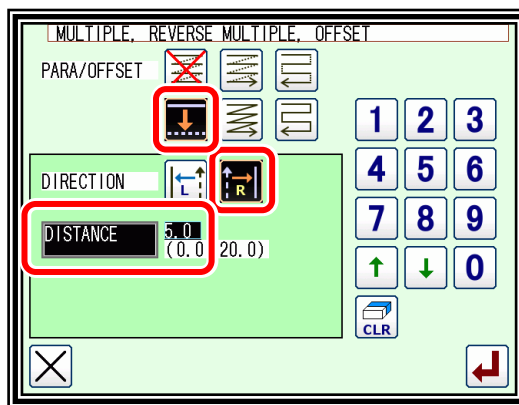

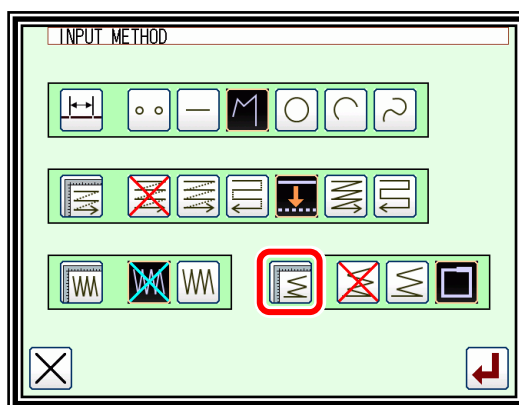

### (3) Setting the back tacking details.

- ▶ After returning to the Input Method Setting screen, press the back tacking details setting icon  .



(4) Setting the overlap back tacking details.

- ▶ The details are set on this screen.  
(The details set here are,  (overlap back tacking),  
overlap mode , three overlap stitches.)

- ▶ Press  to set the data.

The system will return to the input method setting screen.

- ▶ Press  to set the data.

The system will return to the arrow input screen.

Determine the B, C D and A points with the broken line procedures, and create the broken line data.

- ▶ After creating the broken line data, input .

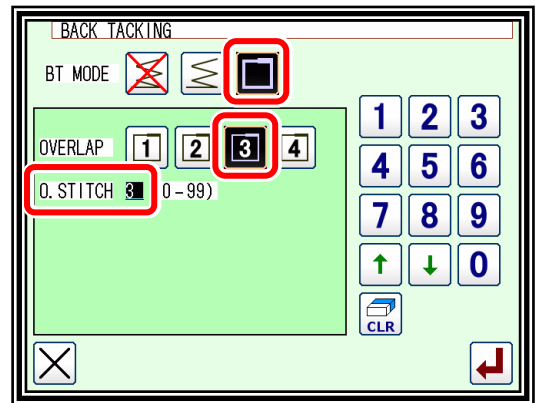

(5) Confirming the data.

- ▶ The offset data will be displayed on the image screen.

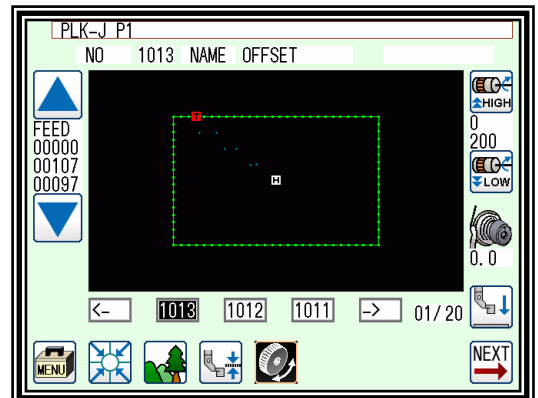

**Note** Or press the MULTI, REVERSE MULTI, OFFSET icon on the arrow input screen to directly display the MULTI, REVERSE MULTI, OFFSET setting screen.

## 12. Zigzag stitching (with overlap back tacking)



[Example] The following type of sewing data will be created.

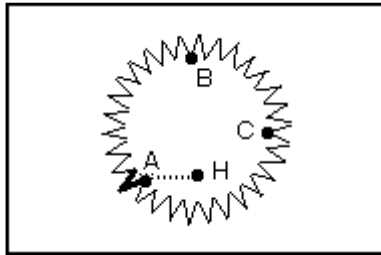

Input zigzag stitching with overlap back tacking as circle. (The zigzag deflection width will be 5.0mm, the feed amount will be 3.0mm, the direction is left, the overlap back tacking mode will be carried out once, and three overlap stitches will be made.)

(The bold section is the overlap back tacking section.)

### Operation details

#### (1) Setting the input method.

▶ Set the feed data from the home position H to the A point with the procedures for broken line input, and open the Input Method Setting screen.

▶ Press Circle .

▶ Press Zigzag .

▶ Press Overlap Back Tacking .

▶ Set the zigzag details. Press .

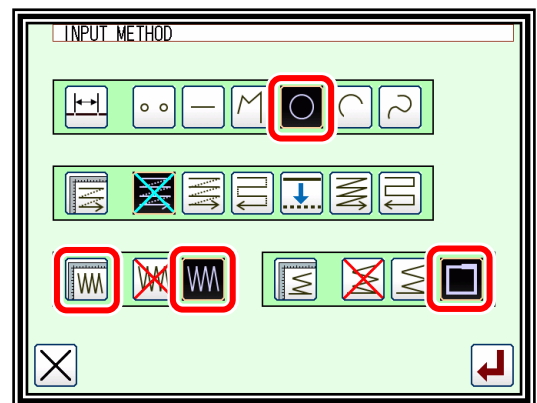

#### (2) Setting the zigzag details.

▶ The details are set on this screen.

(Press , set the deflection width to 5.0, feed amount to 3.0 and direction to "left" )

‡ The zigzag deflection width can be set in 0.1mm increments between 0.2 and 19.0mm.

‡ The zigzag feed amount can be set in 0.1mm increments between 0.2 and 10.0mm.

(Refer to the "Deflection width, feed amount and creation direction" section given later for details.)

▶ After inputting the details, press to set the data.

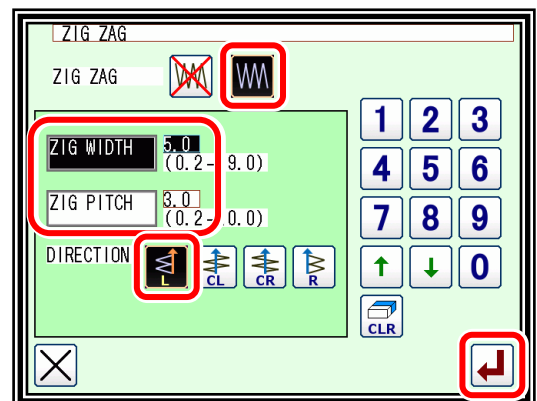

**Note** To input the ZIG WIDTH/ ZIG PITCH, press the ZIG WIDTH/ ZIG PITCH icon to invert the icon. After that, input the data using the numeric icons or the up/down arrow mark icons.

**Note** Deflection width, feed amount and creation direction.

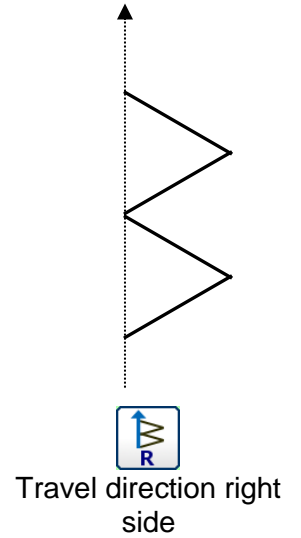
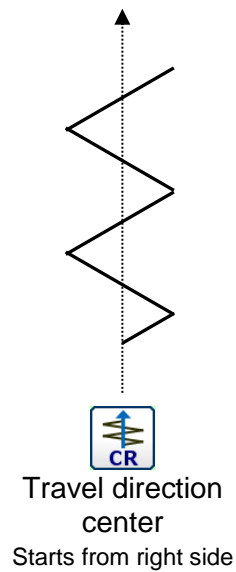
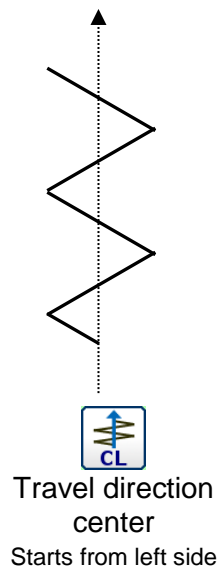
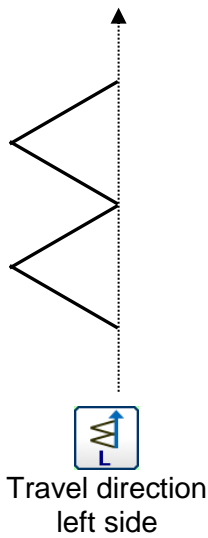
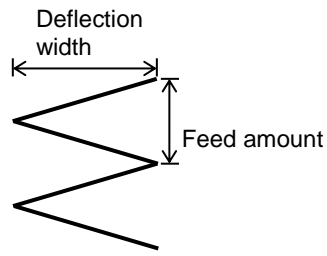

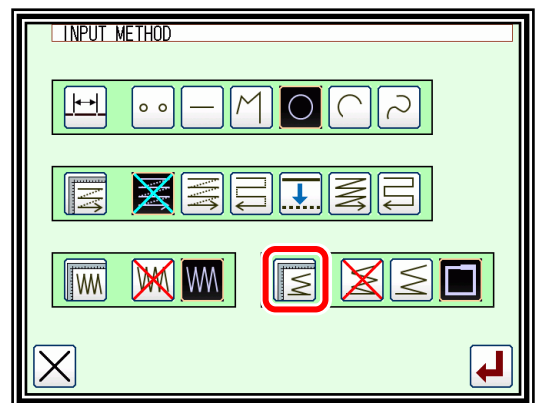

(3) Setting the back tacking details.

► After returning to the Input Method Setting screen, press the back Tacking Details Setting icon  .



(4) Setting the overlap back tacking details.

- ▶ The details are set on this screen.  
(The details set here are  ,  
overlap mode  , three overlap stitches.)
- ▶ After inputting the details, press  to set the data.

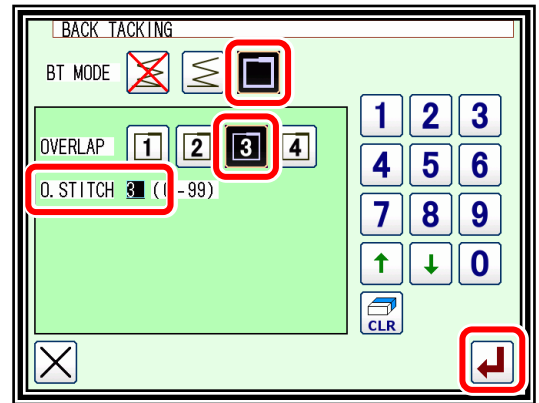

The system will return to the input method setting screen.

- ▶ Press  to determine the set values.

The system will return to the input method setting screen.

While following the circle data entry procedure, determine points B and C to create the circle data.

- ▶ After creating the circle data, press .

(5) Confirming the data.

- ▶ Zigzag stitching. (with overlap back tacking.)

**Note** Or press the ZIGZAG icon on the arrow input screen to directly display the ZIGZAG setting screen.

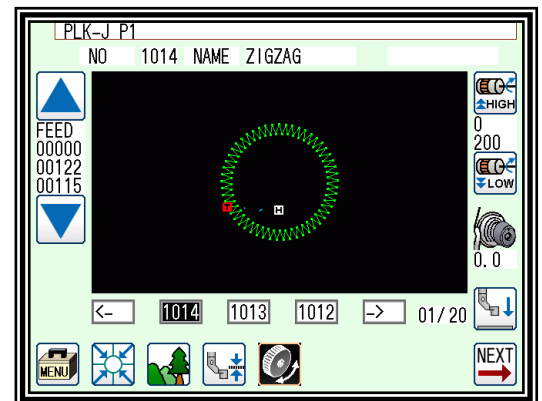

# [8] Controlling the Presser Foot

## 1. Setting for PF height

The lowest position when the presser foot is lowered can be corrected by following setting. Before sewing operation, please adjust the lowest position of the presser foot.

(1) Display standard screen.

▶ Press PF height setting 

**Note** For enter to PF height setting screen, presser foot needs to be up position.

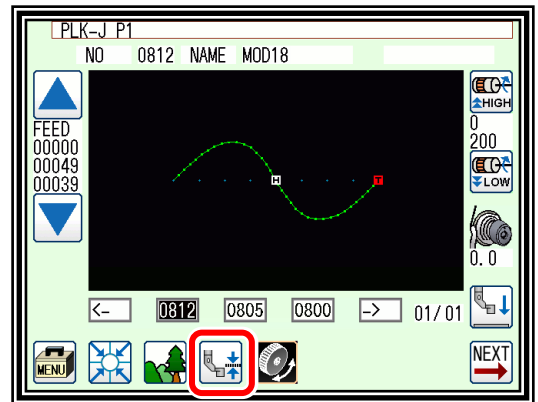

(2) Sets PF height.

▶ Press  to lower the presser foot so you can set the presser foot height.

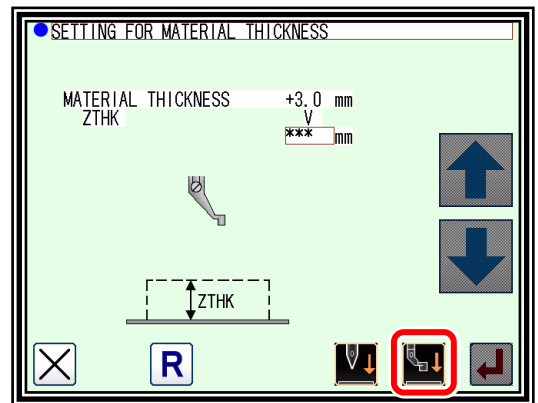

▶ Press up or down arrow icon and adjust PF height. Setting range is from 0.0 mm to 8.0 mm by 0.2 mm resolution. (Example is set in 4.0 mm in right figure.)

▶ After setting value, press .

▶ Setting is complete, then display is back to standard screen.

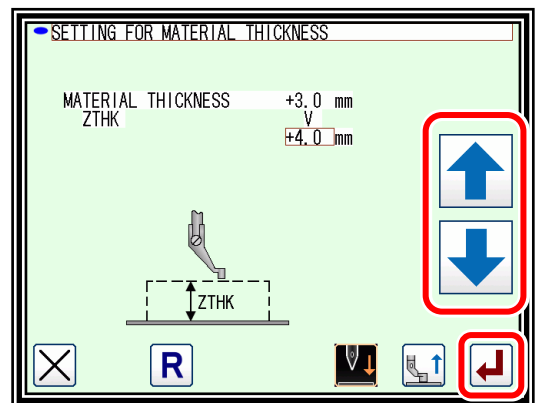









**Note** When HPW = ON, the height of the presser foot stored in the pattern is displayed. Set the presser foot height again, the changed presser foot height will be saved in the pattern.







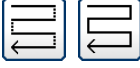

**Note** Press  to set the reference point of DFTH.

Even if the power is turned OFF / ON, the reference value remains at the set value



# [9] Table of stitching type combinations

Basic input	Application input					
	Multiple 	Reverse multiple 	Offset 	Zigzag 	Start/end back tacking 	Overlap back tacking 
Linear 	Yes					
		Yes				
			Yes			
				Yes		
	Yes				Yes	
	Yes			Yes		
	Yes				Yes	
		Yes		Yes		
		Yes			Yes	
		Yes		Yes	Yes	
			Yes	Yes		
			Yes		Yes	
			Yes	Yes	Yes	
			Yes	Yes	Yes	
Arc 	Yes					
		Yes				
			Yes			
				Yes		
	Yes			Yes		
	Yes				Yes	
	Yes			Yes	Yes	
		Yes		Yes		
		Yes			Yes	
			Yes	Yes		
			Yes		Yes	
			Yes	Yes	Yes	
			Yes	Yes	Yes	
			Yes	Yes	Yes	
Circle 	Yes					
		Yes				
			Yes			
				Yes		
					Yes	
						Yes
	Yes			Yes		
	Yes				Yes	
	Yes					Yes
	Yes			Yes	Yes	
	Yes			Yes		Yes
		Yes		Yes		
		Yes			Yes	
		Yes		Yes	Yes	
		Yes		Yes		Yes
			Yes	Yes		
			Yes		Yes	
			Yes	Yes	Yes	

Basic input	Application input					
	Multiple 	Reverse multiple 	Offset 	Zigzag 	Start/end back tacking 	Overlap back tacking 
Curve 	Yes					
		Yes				
			Yes			
				Yes		
					Yes	
						Yes
	Yes			Yes		
	Yes				Yes	
	Yes					Yes
	Yes			Yes	Yes	
	Yes			Yes		Yes
		Yes		Yes		
		Yes			Yes	
		Yes				Yes
		Yes		Yes	Yes	
		Yes		Yes		Yes
			Yes	Yes		Yes
			Yes		Yes	
			Yes	Yes	Yes	Yes
				Yes	Yes	Yes
Broken line 	Yes					
		Yes				
			Yes			
				Yes		
					Yes	
						Yes
	Yes			Yes		
	Yes				Yes	
	Yes					Yes
	Yes			Yes	Yes	
	Yes			Yes		Yes
		Yes		Yes		
		Yes			Yes	
		Yes				Yes
		Yes		Yes	Yes	
		Yes		Yes		Yes
			Yes	Yes		
			Yes		Yes	Yes
			Yes	Yes		Yes
				Yes	Yes	
			Yes		Yes	
Point 	(Combination inputs with application inputs are not possible.)					

Combined pattern

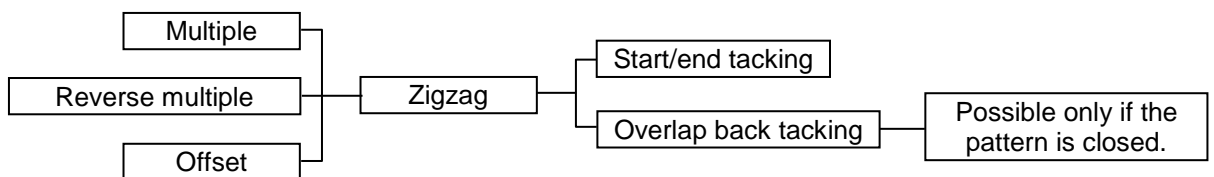

One of the three can be selected.

One of the two can be selected

# [10] Call-up function

In the sewing data input mode, you can call up the sewing data from the internal memory, and can combine the called-up data with the currently-created data to create a new sewing data. You can determine whether the first and final feed data should be deleted.

[Example of call-up function]

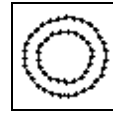

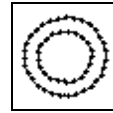

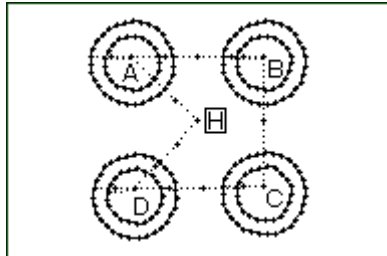
To create the following sewing data, preliminarily create the double circle data (  ), and then use the feed data and call-up functions.



## Operation details

- (1) Creation of data on feed data from home position H to point A.
- (2) Display of call-up screen.

- ▶ Press the data entry mode  .
- ▶ Press  in the menu.

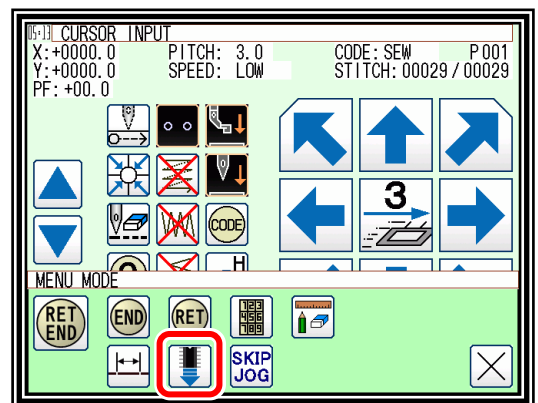



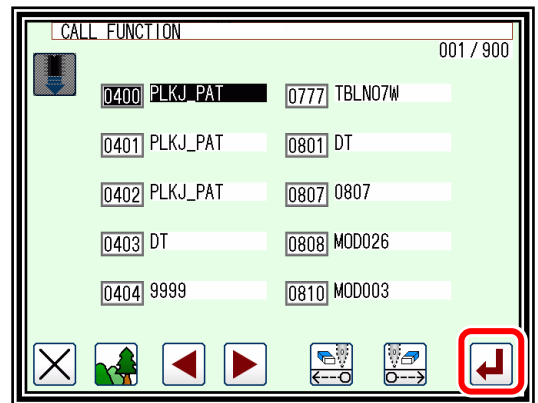

- (3) Selection of call-up data.

- ▶ Select data to be called up, and then press  .

**Caution**  The work holder will automatically move in accordance with the called-up data. If the needle is lowered, be careful not to get injured.



**Note** After calling up "feed" data, you can modify the original "feed" data as follows

-  : The feed data at the sewing start point can be deleted.
-  : The feed data at the sewing end point can be deleted.
-  : The feed data at the sewing start point can be left undeleted.
-  : The feed data at the sewing end point can be left undeleted.

Start

End































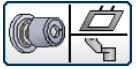

Delete

Undelete



- (4) For B, C, and D, call up the data in the same way, and complete the data.

# [11] Modification mode

## 1. Main modification mode functions



Function	icon	Details	Details setting
 Stitch	Modifying the stitching start position (page [11]-6)	 The stitching start position moves.	-
	Deleting a stitch (page [11]-8)	 Deletes the designated stitch.	 Designated No. of Stitches.  All After Designated Stitch.
	Adding a stitch (page [11]-12)	 Data for one stitch is added at designated position.	 One Stitch Addition.  Same Stitch Addition.
	Modifying the stitch position (page [11]-16)	 The position of the stitch is modified.	<After modification position>  Fixed  Relative Movement.
	Moving a block (page [11]-20)	 Data in a designated range is moved.	<Prior/Subsequent data>  Change  Add new stitch in between.
	Modifying a block (page [11]-24)	 The area between two points to be modified is modified with linear, broken line, arc, curve, zigzag or feed data.	-
	Modifying stitch length (page [11]-39)	 The stitch length in the designated range is modified.	 Designated distance modification  All After Designated Stitch.
 Modify sewing quality items	M3 feed angle width setting (page [11]-49)	 Sets the speed and angle (operating speed) of the feed plate on X and Y axes.	-
	Digital tension setting (page [11]-51)	 Set the strength of the tension.	-
	PF holding power setting (page [11]-53)	 Set the holding power (torque) of Presser foot.	-
	PF stroke setting (page [11]-55)	 Set the stroke (amplitude) of Presser foot.	-
	PF height (page [11]-57)	 Modify the height of the Presser foot at the specified position.	-
Modifying the stitching speed (page [11]-43)	 The stitching speed is modified from the designated stitch.	 Designated No. of Stitches.  All After Designated Stitch.	
Modifying code data (page [11]-46)	 Code data is added to or deleted from designated stitch position.	 Add  Delete	

## 2. Entering the modification mode

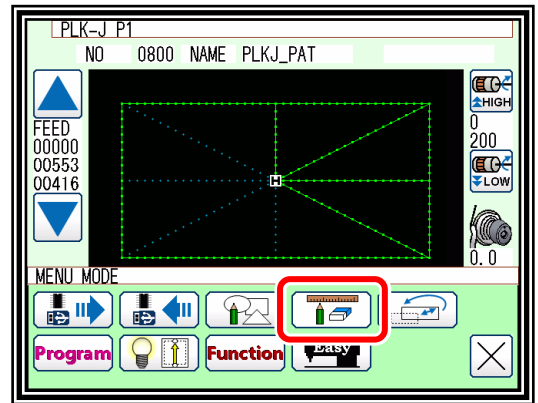
- (1) Press  and  on the Standard screen to enter the modification mode.



Method that uses standard

- (2) Press  and  in the input mode to enter the modification mode.

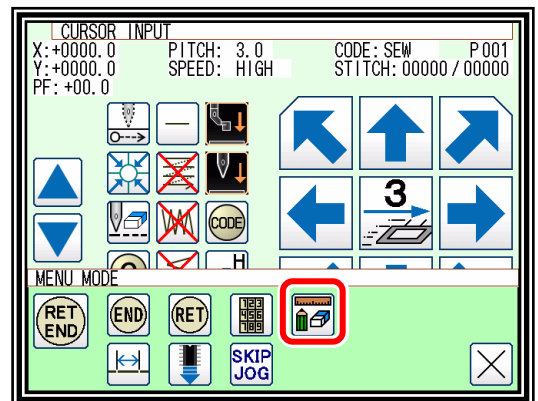

Method that uses data input

## 3. Quitting the modification mode

- After making modifications, press  to quit the modification mode.

(When  is pressed, the modifications executed last will be undone.)

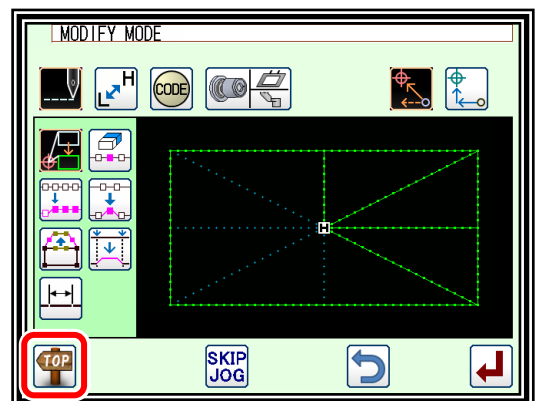

## 4. Changing the feed data to home position

- ▶ An example for adding the A' point by adding one stitch to the original stitching data, as shown on the left, is explained in this section.

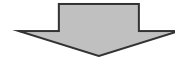
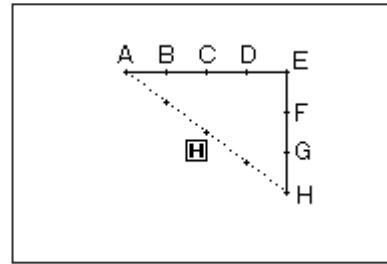

- ▶ Add the A' point as shown on the right.

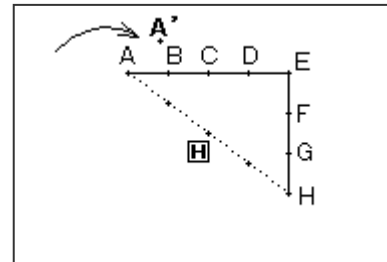

- ▶ The B point to H point positions will change when the A' point is added. Thus, the feed data from the H point to the home position will also change. The method for changing this feed data can be selected with the following icons.

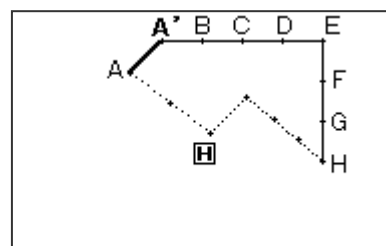
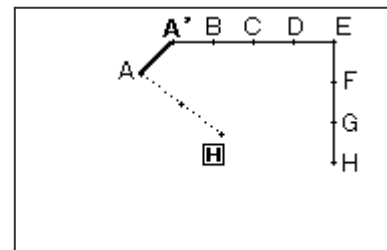

[ Add return ]

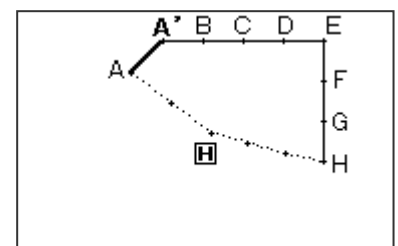

[ Change return ]

**Note** Before modification, check the data. If the data on feed data from the sewing end point to the home position includes code data, the feed data following the code data will be modified.

## 5. Confirming on the image screen

If the image display icon  is pressed in the input mode, modification mode or conversion mode, the Image screen will open. This Image screen can be used effectively when modifying (converting) data in the modification (conversion mode), and the data can be modified (converted) easily.

An example of the Image screen in the modification mode is shown below. The Image screen can be confirmed after the data modification (conversion) mode is entered, regardless of before and after modifications made.

▪When stitching start position is modified.

 : Closes the Image screen, and opens the previous screen. (Common for all Image screens.)

**H** : Indicates the home position.  
(Common for all Image screens.)

**S** : Indicates the original stitching start position.

**P** : Indicates the modified stitching start position.  
(Current position moved to with the arrow icons.)

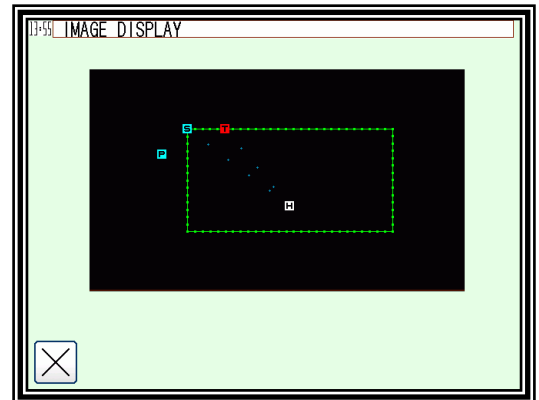

<Only the image section is shown in the following explanations.>

▪Deleting stitches

**H** : Indicates the home position.  
(Common for all Image screens.)

**S** : Indicates the stitch deletion start position.

**E** : Indicates the stitch deletion end position.

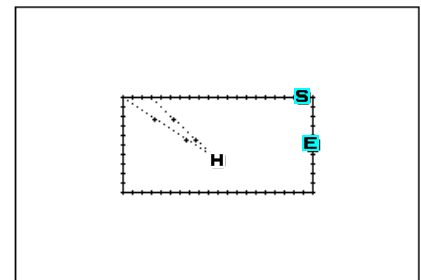

▪Modifying the stitch position and adding stitches.

**H** : Indicates the home position.  
(Common for all Image screens.)

**S** : Indicates the original stitch position/stitch addition reference position.

**P** : Indicates the modified stitch position/added stitch position. (Current position moved to with the arrow icons.)

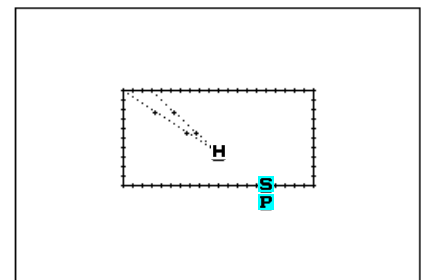

▪Moving a block

**H** : Indicates the home position.  
(Common for all Image screens.)

**S** : Indicates the block movement start position.

**E** : Indicates the block movement end position.

**P** : Indicates the position after block movement modification.

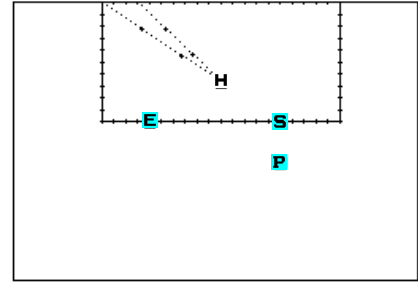

▪Modifying a block (The broken line input data is created with block modification.)

**H** : Indicates the home position.  
(Common for all Image screens.)

**S** : Indicates the block modification start position.

**E** : Indicates the block modification end position.

**1** : Broken line transit point 1.

**2** : Broken line transit point 2.

**3** : Broken line transit point 3.

**4** : Broken line transit point 4.

**P** : Indicates the current position moved to with the arrow icons.

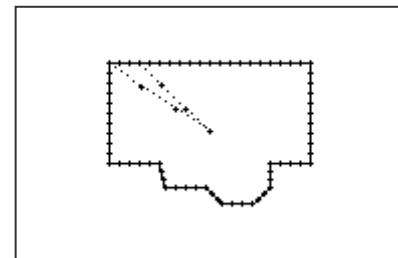
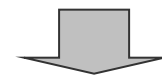
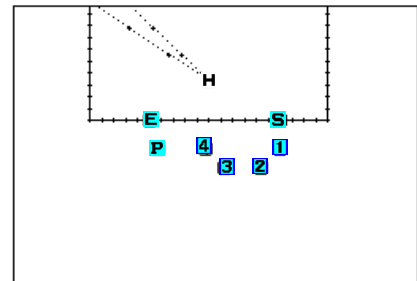



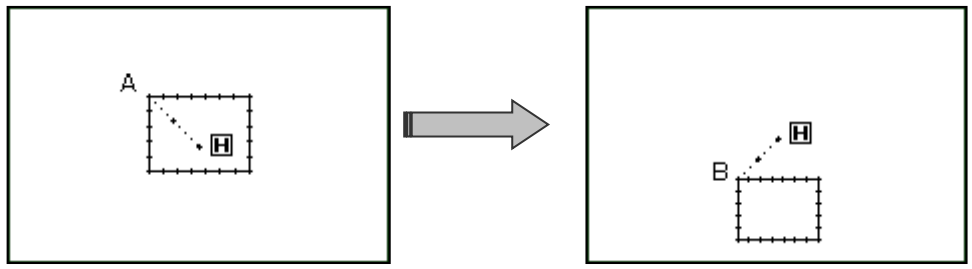

## 6. Modifying the stitching start position

[Example] The stitching start position A point in the stitching data will be modified to the B point as shown below.



### Operation details

(1) Selecting the stitching start position movement.

- ▶ Enter the modification mode. (Refer to Page [11] - 2)
- ▶ Press Stitch Data Change  and Stitching Start Position Move .
- ▶ Press  to set the data.

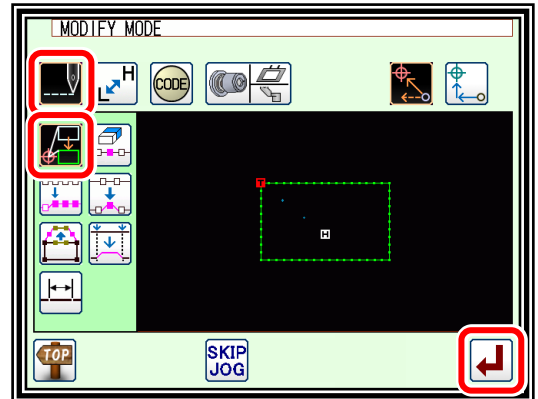



**Caution**  The work holder will automatically move to the current stitching start position. (\*1)Take care when the needle is lowered, etc.

(2) Moving to the modification position and setting the data.

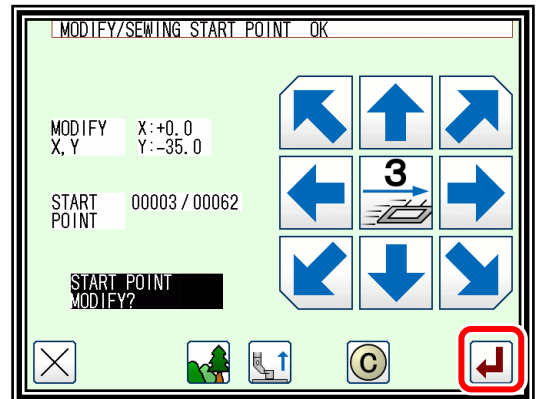

- ▶ Press the arrow icons to move the position to the B point.
  - ▶ Press .
- (The sewing start position will be modified.)

**Caution**  When the modifications are undone, the work holder will automatically return to the home position. Take care when the needle is lowered, etc.



- ▶ If  is pressed here, the screen will change to the previous screen.

(3) Confirming the modified data.

- ▶ Quit the modification mode. Press  to change to the saving mode screen. It returns to the standard screen after saving the data. (When  is pressed, the modifications executed last will be undone.)

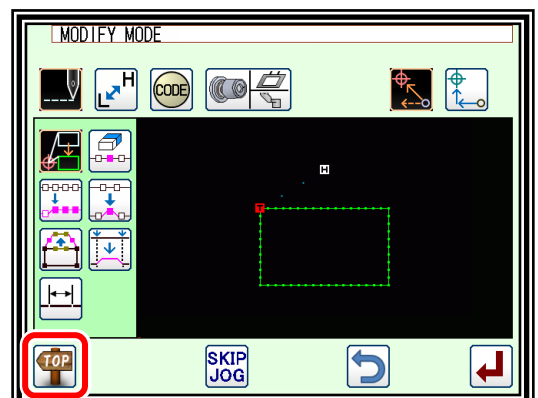

(4) Select a saving method.

► After selecting the saving method, press  icon.

**Note** If you try to write an existing data number, you will see a message to confirm overwriting.

► After saving the data, it returns to the standard screen.

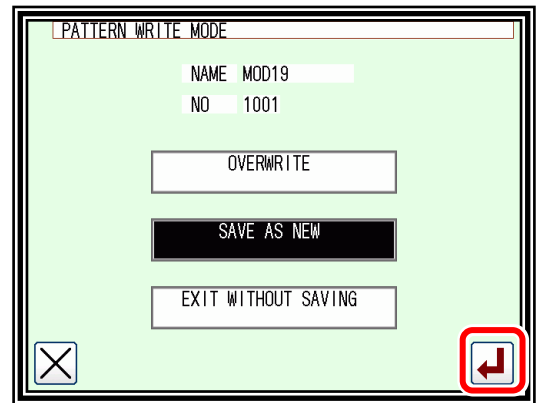

(5) Confirming with the Standard screen.

► The stitching start position has been modified.

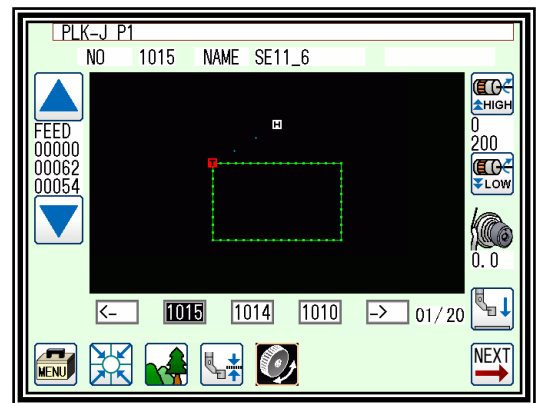

(\*1)

**Note** Please note that there is a characteristic explained as follows about "Modifying the stitching start position" of the data with the back tacking. The data of the figure below is the straight line data which puts the start/end back tacking of V mode. (A fat part is back tacking). In this case, is sewn in order of A→B→C→D. Therefore, the actual stitch starting position is "A point." (Starting location of the data origination (input) is "B point.")



Please specify whether to correct the B point because "Starting location (B) at the data input "after work holder automatically moves to "Actual stitch starting position (A)" when enters to "Modifying the stitching start position".

## 7. Deleting a stitch



### (Deleting the designated No. of stitches)

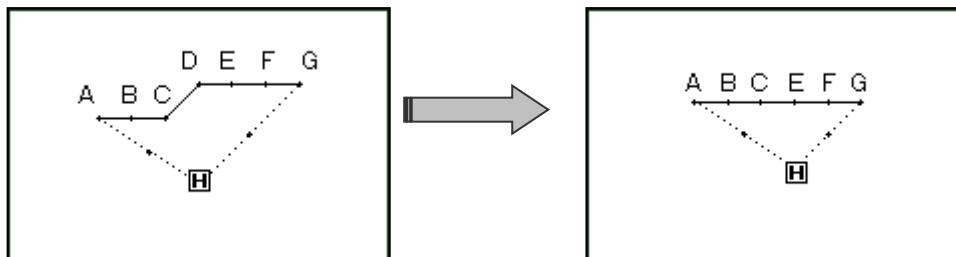

[Example] The stitching pattern between the C point and D point in the following type of stitching data will be deleted.



#### Operation details

(1) Selecting deletion of stitches.

▶ Enter the modification mode. (Refer to Page [11] - 2)

▶ Press Stitch Data Change  and  
Stitch Delete .

▶ Press  to open the next screen.

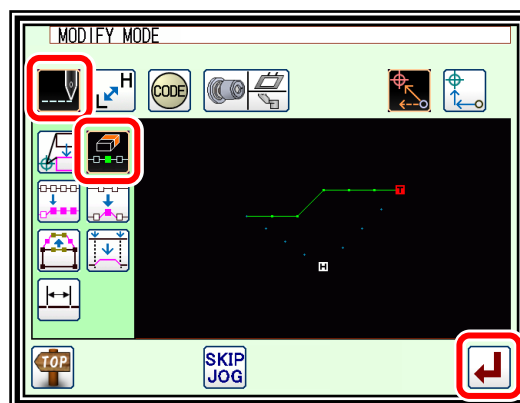

(2) Determining the deletion method and the deletion range. (start point)

▶ Press No. of Stitch Designation .

▶ Using Jog   determine the start point position (C point).

▶ Press  when the position has been set.

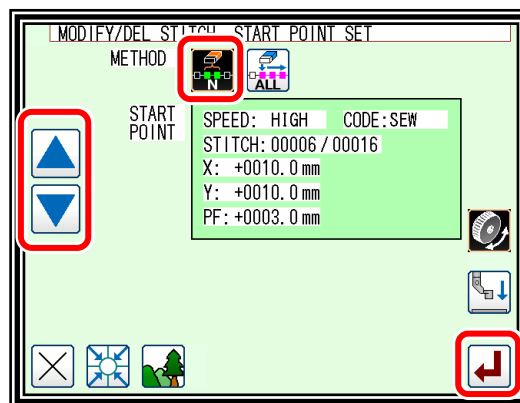

(3) Determining the deletion range. (end point)

▶ Using Jog   determine the end point position (D point).

▶ Press  when the position has been set.

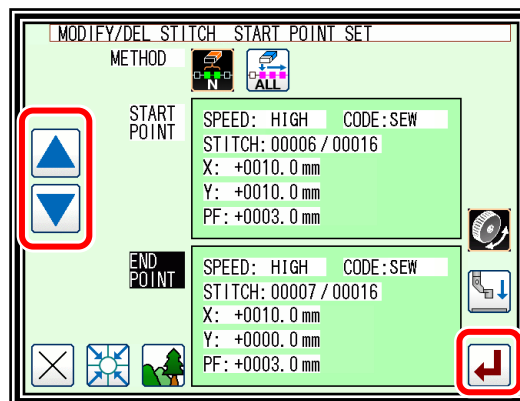

**Caution** When the end point is determined, the work holder will automatically return to the start point. Take care when the needle is lowered, etc.

(4) Confirming execution.

▶ Press  .

(The stitch will be deleted.)



(5) Confirming after stitch deletion.

▶ Quit the modification mode. Press  to change to the saving mode screen. It return to the standard screen after saving the data.

(When  is pressed, the modifications executed last will be undone.)

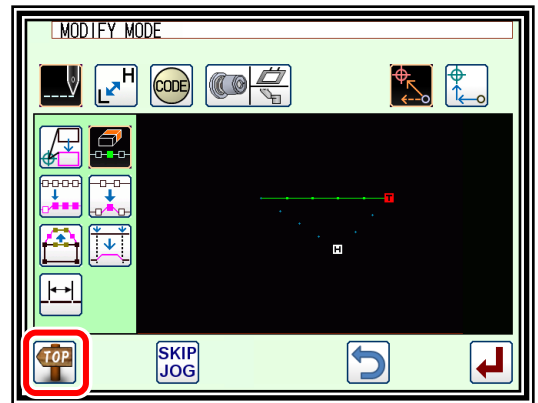

(6) Confirming with the Standard screen.

▶ The stitch has been deleted.



## 8. Deleting a stitch

### (Deleting all stitches after the designated position)

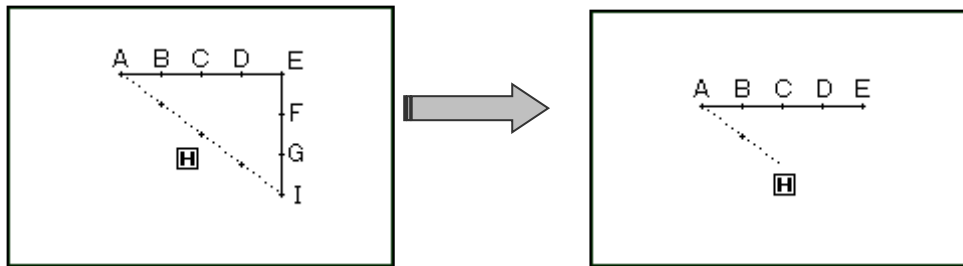

[Example] The stitching pattern after the E point in the following type of stitching data will be deleted.



#### Operation details

(1) Selecting deletion of stitches.

▶ Enter the modification mode. (Refer to Page [11] - 2)

▶ Press Stitch Data Change  and  
Stitch Delete .

▶ Press  to open the next screen.

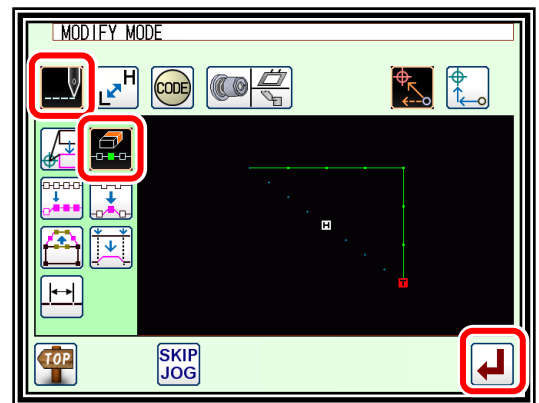

(2) Determining the deletion method and the deletion range. (start point)

▶ Press All after Designated Stitch . (All the data below the specified position will be deleted.)

▶ Using Jog   determine the start point position (E point).

▶ Press  when the position has been set.

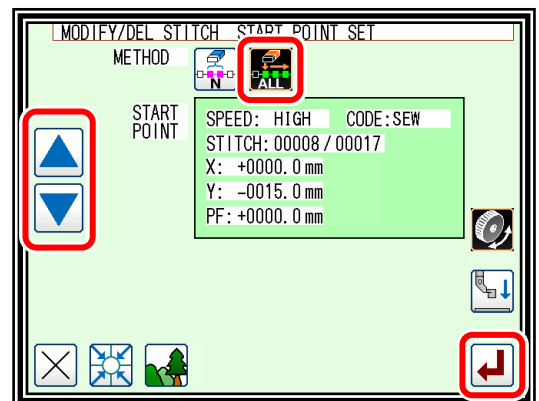



(3) Confirming execution.

▶ press .  
(All the data below the specified position will be deleted.)



(4) Confirming after stitch deletion.

- ▶ Quit the modification mode. Press  to change to the saving mode screen. It return to the standard screen after saving the data.  
(When  is pressed, the modifications executed last will be undone.)

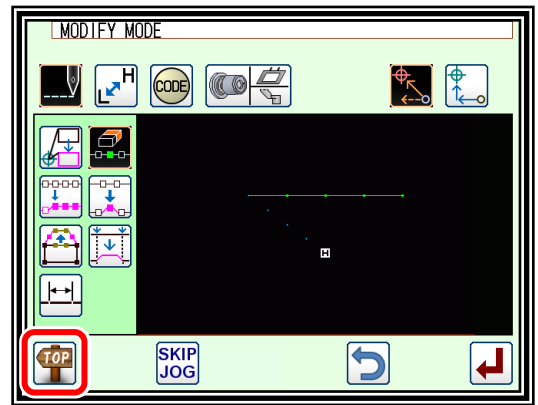

(5) Confirming with the Standard screen.

- ▶ The stitches have been deleted.



## 9. Adding a stitch (Adding one stitch)



[Example] The required stitch length A' will be added to the A point of the following type of stitching.  
(The maximum stitch length is 20mm (between A and A').)

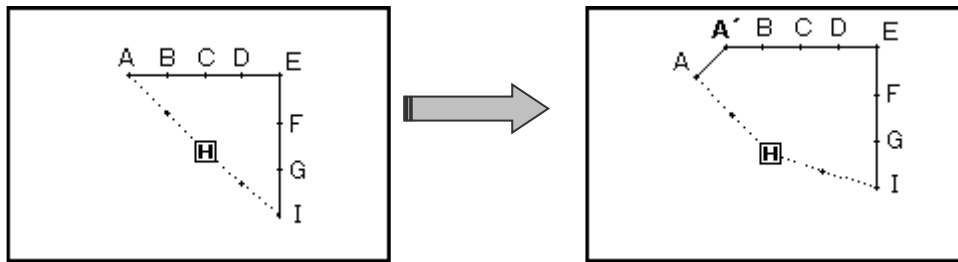

### Operation details

(1) Selecting stitch addition.

▶ Enter the modification mode. (Refer to Page [11] -2)

▶ Press **Stitch Data Change**

and **Stitch Add**

▶ Press to open the next screen.

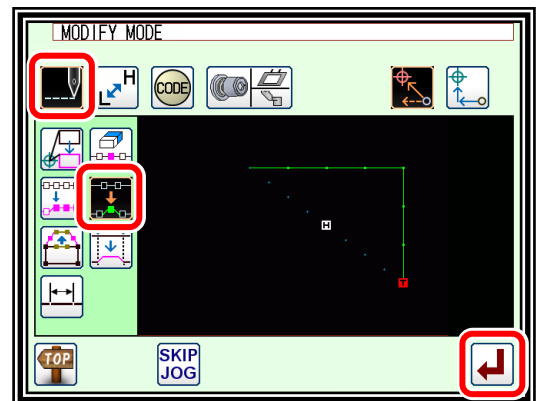

(2) Determining the addition position.

▶ Using Jog determine the position to be added. Move to the addition position (point A).

▶ Press when the position has been set.

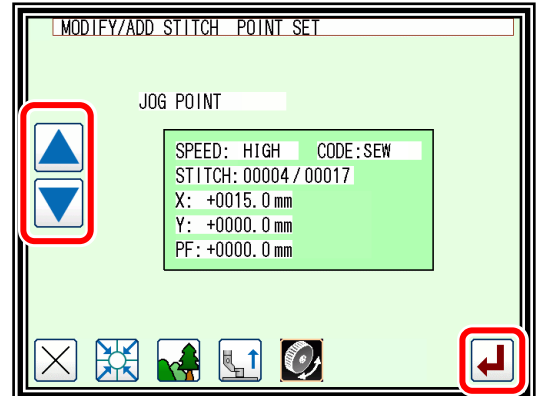



(3) Setting the addition method.

▶ Press **One Stitch Addition** , and then use the arrow icons to move and input the stitch position to be added. (A' point)

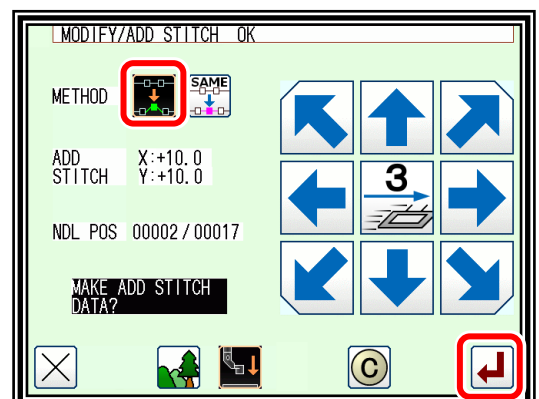
▶ Press .  
(One stitch will be added.)



(4) Confirming after stitch addition.

- ▶ Quit the modification mode. Press  to change to the saving mode screen. It return to the standard screen after saving the data.  
(When  is pressed, the modifications executed last will be undone.)

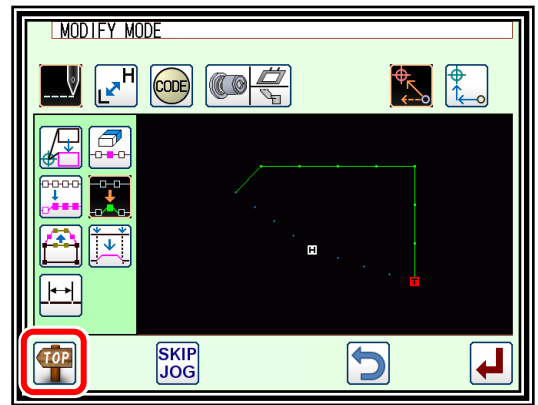

(5) Confirming with the Standard screen.

- ▶ One stitch has been added.

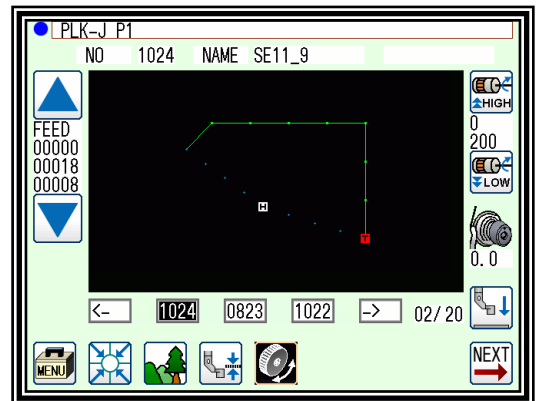



## 10. Adding a stitch (Adding the same stitch)



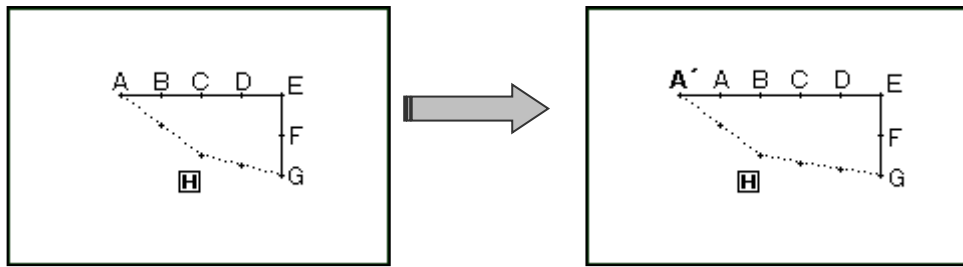

[Example] The stitch A' point, the same as A, will be added to the A point of the following type of stitching data.



### Operation details

(1) Selecting stitch addition.

▶ Enter the modification mode. (Refer to Page [11] - 2)

▶ Press Stitch Data Change  and Stitch Add .

▶ Press  to open the next screen.

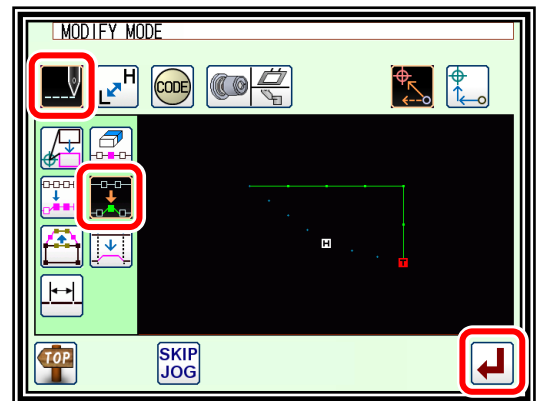



(2) Determining the addition position.

▶ Using Jog   determine the position to be added. Move to the addition position (point A).

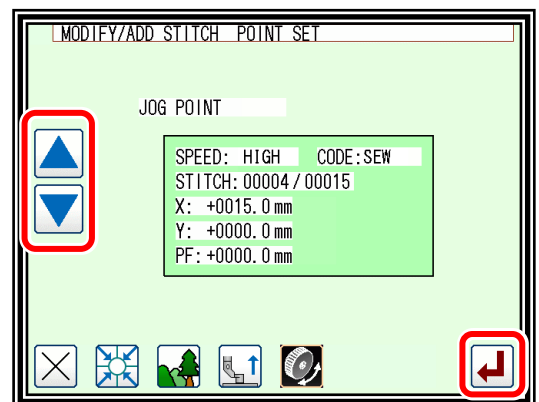
▶ Press  when the position has been set.





(3) Setting the addition method.

▶ Press Same Stitch Addition , and then press .

(The same stitch will be added.)



(4) Confirming after stitch addition.

- ▶ Quit the modification mode. Press  to change to the saving mode screen. It return to the standard screen after saving the data.  
(When  is pressed, the modifications executed last will be undone.)

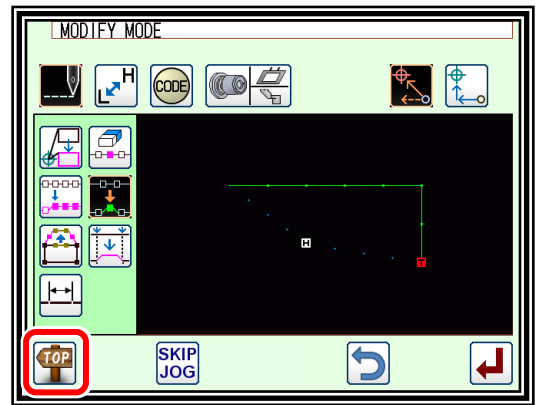

(5) Confirming with the Standard screen.

- ▶ The same stitch has been added.

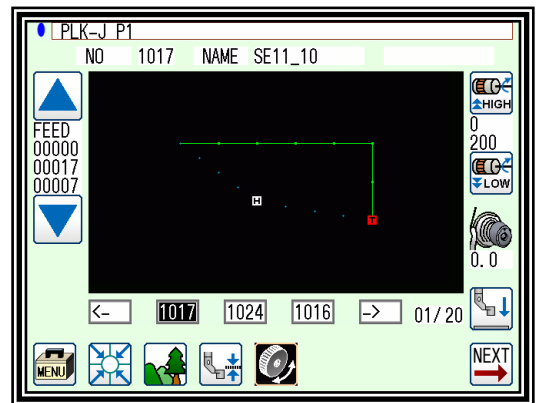

# 11. Modifying the stitch position (Position of subsequent data fixed)

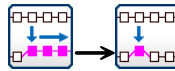

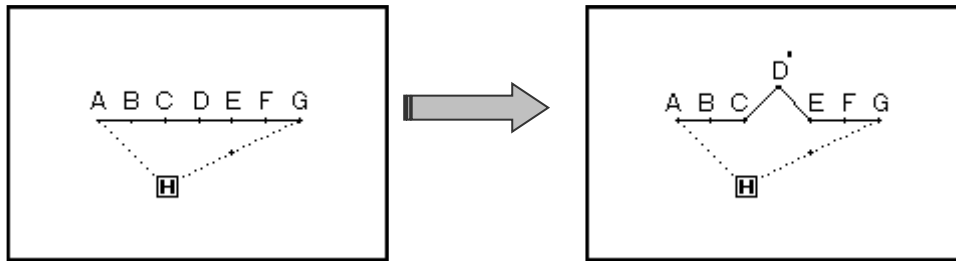

[Example] The D point in the following type of stitching data will be moved.





## Operation details

(1) Selecting stitch position modification.

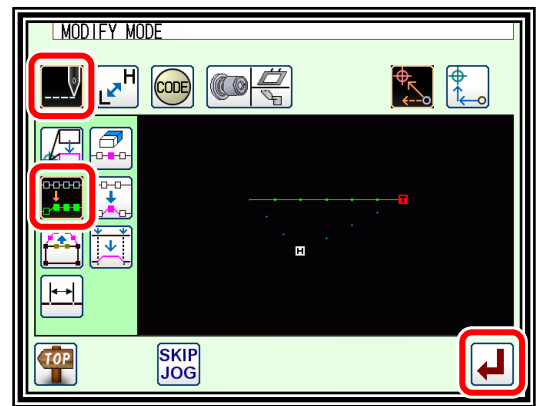
- ▶ Enter the modification mode. (Refer to Page [11] - 2)
- ▶ Press Stitch Data Change  and Stitch Position Modify .
- ▶ Press  to open the next screen.



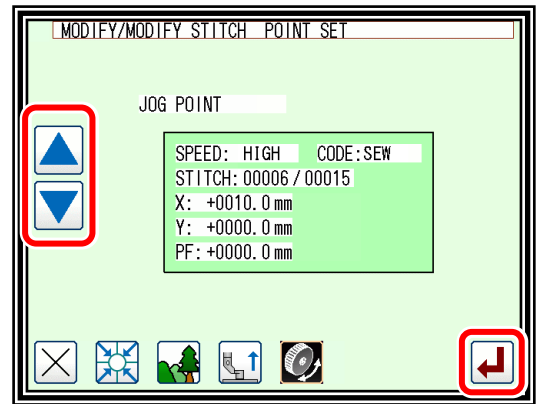

(2) Determining the modification position.

- ▶ Using Jog   determine the position to be modified. (D point)
- ▶ Press  when the position has been set.



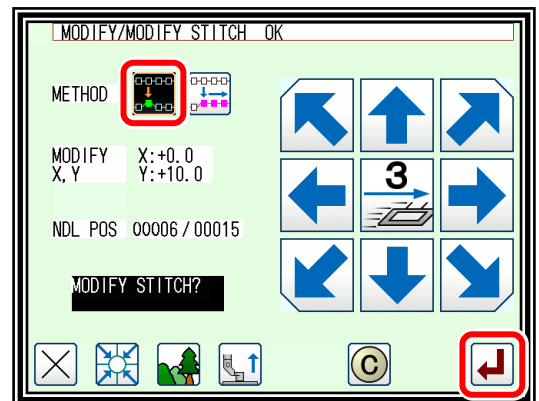

(3) Setting the modification method and modification amount.

- ▶ To set the method, press  (pattern data after modification stitch fixed), and move to the modification position (point D') using the arrow mark icons.
- ▶ Press . (The stitch position will be modified.)



**Note** Move the stitch length so that it is within the range of 20mm at the maximum.

(4) Confirming after modification.

- ▶ Quit the modification mode. Press  to change to the saving mode screen. It return to the standard screen after saving the data.  
(When  is pressed, the modifications executed last will be undone.)

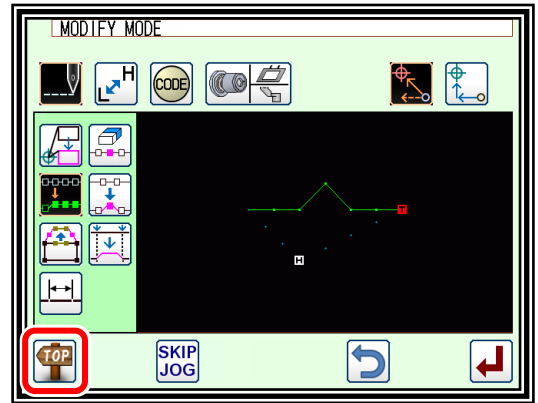

(5) Confirming with the Standard screen.

- ▶ The stitch position has been modified.

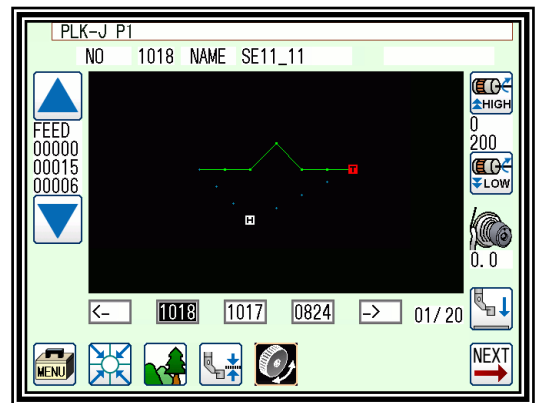

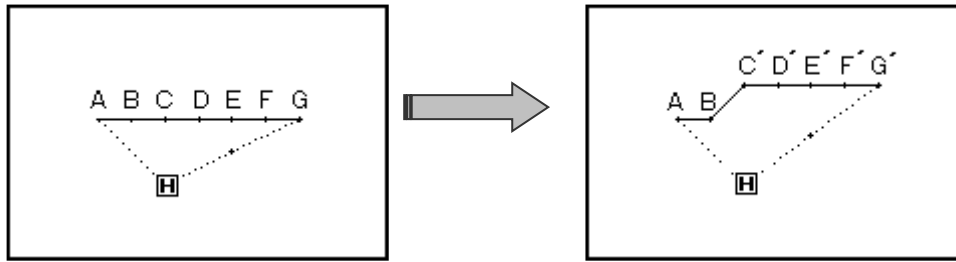

## 12. Modifying the stitch position (Subsequent data position moved)

[Example] The C point in the following type of stitching data will be moved.  
(The D, E, F and G points will move)





### Operation details

(1) Selecting stitch position modification.

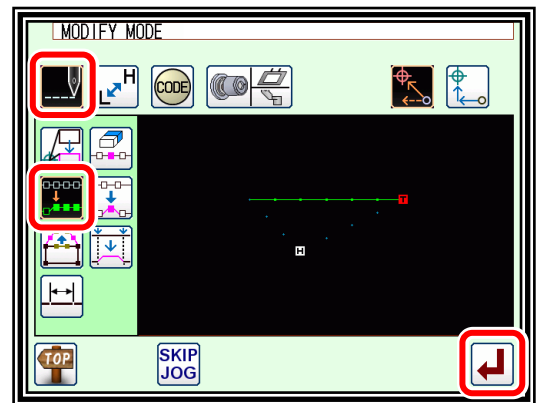
- ▶ Enter the modification mode. (Refer to Page [11] - 2)
- ▶ Press Stitch Data Change  and  
Stitch Position Modify .
- ▶ Press  to open the next screen.



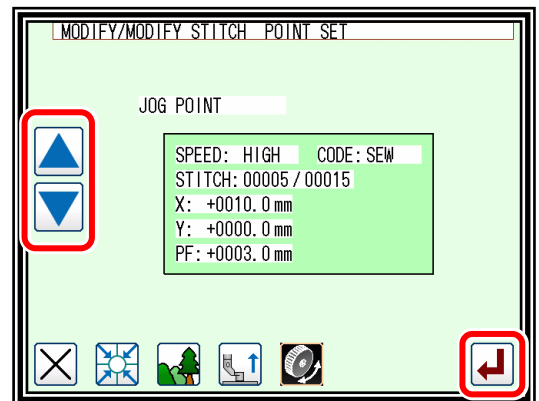

(2) Determining the modification position.

- ▶ Using Jog   determine the position to be modified. (C point)
- ▶ Press  when the position has been set.



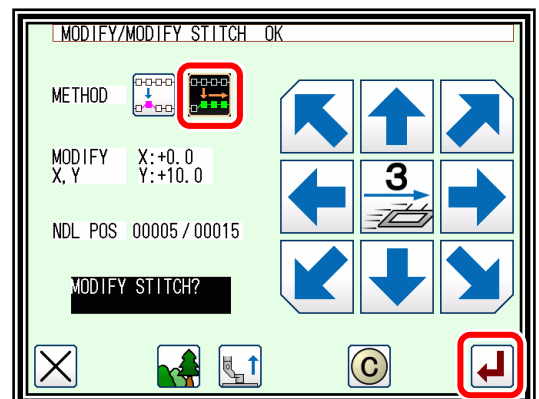

(3) Setting the modification method and modification amount.

- ▶ To set the method, press .  
(pattern data after modification stitch moved), and Move to the modification position (point C') using the arrow mark icons.
- ▶ Press .
- (The stitch positions will be modified.)



**Note** Move the stitch length so that it is within the range of 20mm at the maximum.

(4) Confirming after modification.

- ▶ Quit the modification mode. Press  to change to the saving mode screen. It return to the standard screen after saving the data.  
(When  is pressed, the modifications executed last will be undone.)

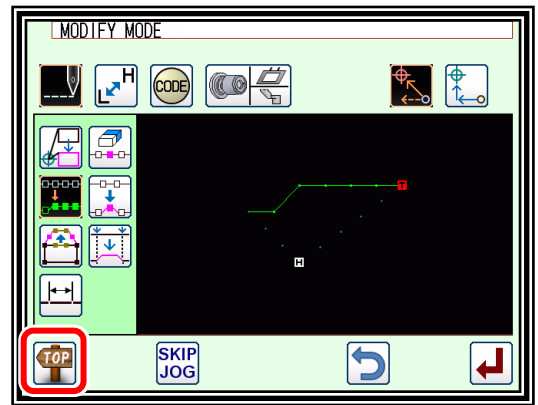

(5) The stitch position has been modified.

- ▶ The stitch positions have been modified.

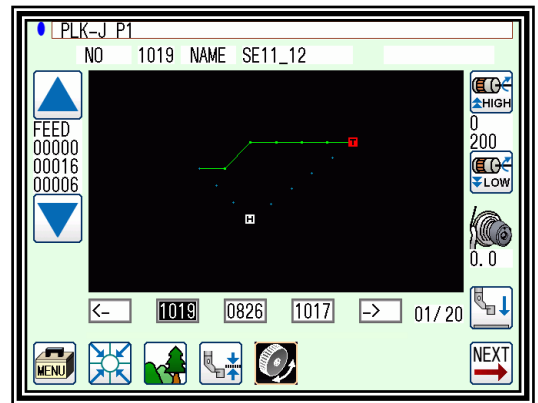

### 13. Moving a block (Changing the prior/subsequent data)

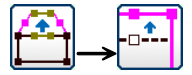

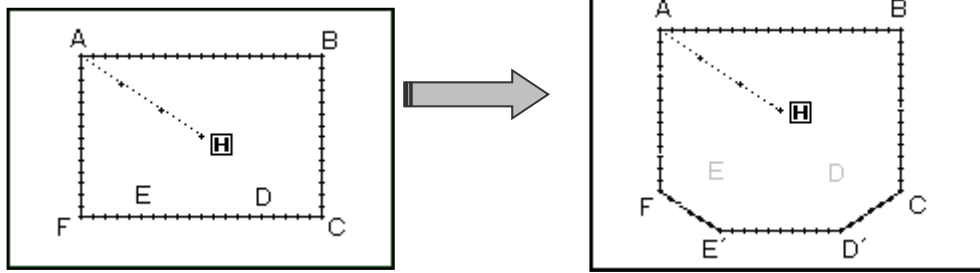

[Example] The section between the D point and E point of the following type of stitching data will be moved to the D' point to E' point. At this time, the data prior to and after the D' point to E' point will be changed.



#### Operation details

(1) Selecting block movement.

▶ Enter the modification mode. (Refer to Page [11] - 2)

▶ Press **Stitch Data Change**  and **Block Move** .

▶ Press  to open the next screen.

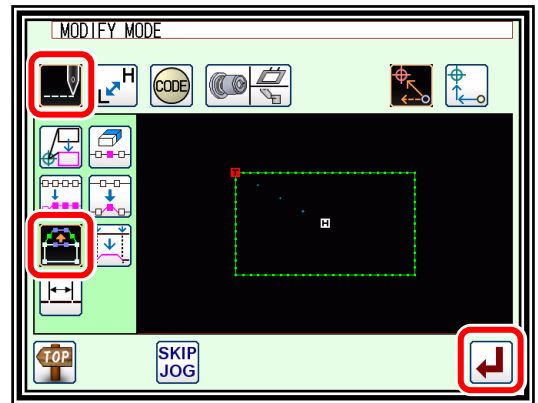

(2) Determining the block modification range. (start point)

▶ Using Jog   determine the start point position. (D point)

▶ Press .

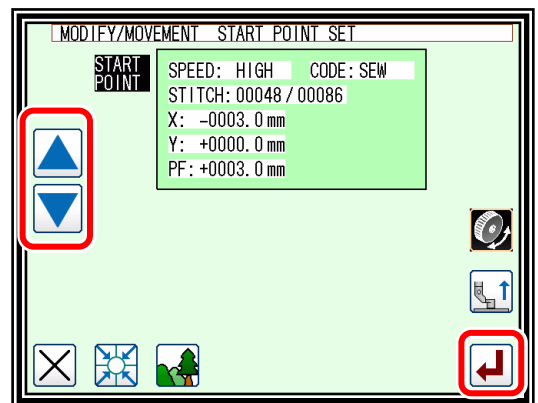

(3) Determining the block modification range. (end point)

▶ Using Jog   determine the end point position.

▶ Press .

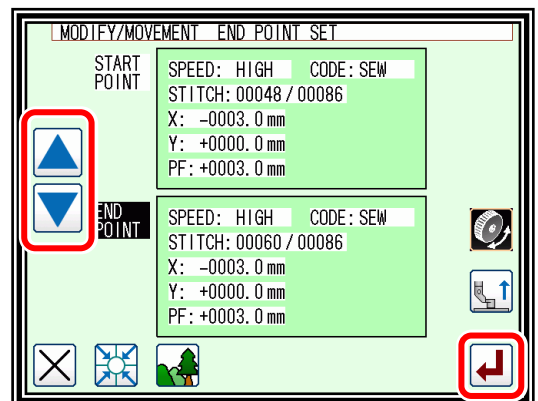

**Caution** When the end point is determined, the presser will automatically return to the start point. Take care when the needle is lowered, etc.

(4) Setting the movement method and stitch length.

▶ Set the movement method. Press Prior/Subsequent Data Change .

▶ Set the stitch length.  
(Set to 3.0mm for this example.)

▶ Press .

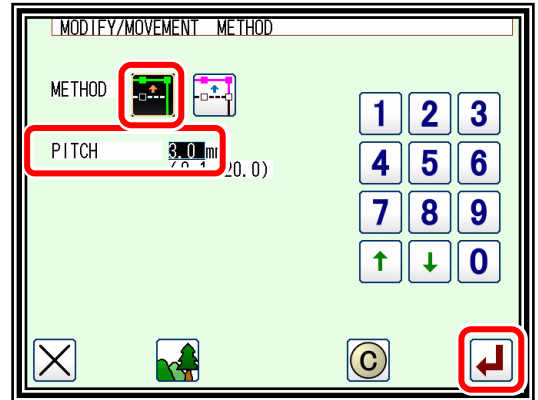



(5) Determining the movement amount.

▶ Using the arrow icons, determine the movement amount. "Move to the position. (point D')."

▶ Press .

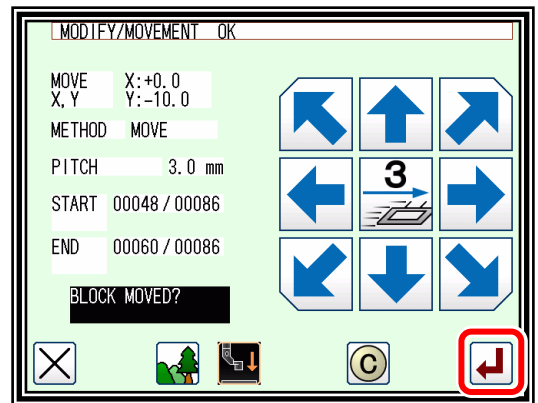
(The block position will be modified.)



 **Caution** The work holder will move.  
(The work holder will return to the start point of the section being modified; in this case the start point (A point) of the broken line input.)  
Take care when the needle is lowered, etc.

(6) Confirming after modification.

▶ Quit the modification mode. Press  to change to the saving mode screen. It return to the standard screen after saving the data.

(When  is pressed, the modifications executed last will be undone.)

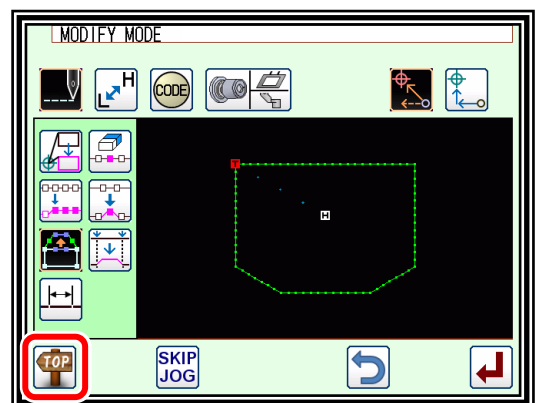



# 14. Moving a block

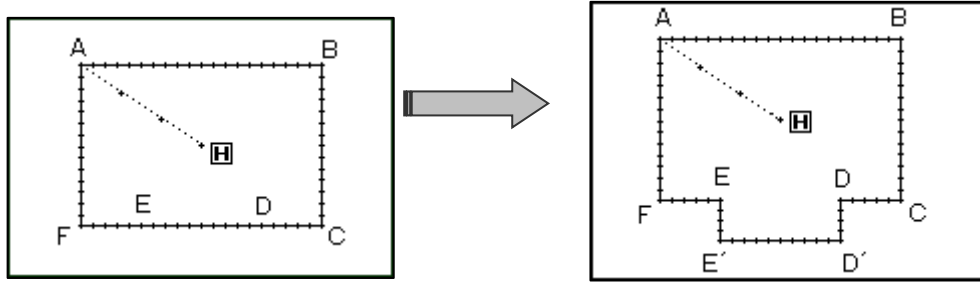

## (Adding new data to the prior/subsequent data)

[Example] The section between the D point and E point of the following type of stitching data will be moved to the D' point to E' point. At this time, new data will be added prior to and after the D' point to E' point. (The D point to D' point and the E point to E' point)





### Operation details

(1) Selecting block movement.

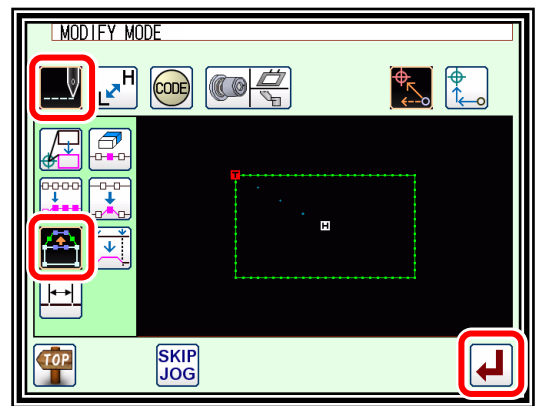
- ▶ Enter the modification mode. (Refer to Page [11] - 2)
- ▶ Press Stitch Data Change  and Block Move .
- ▶ Press  to open the next screen.



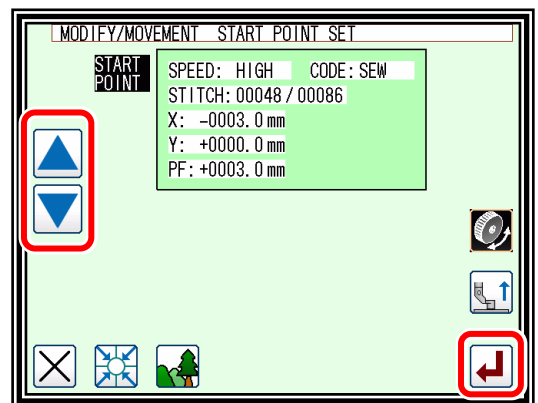

(2) Determining the block modification range. (start point)

- ▶ Using Jog   determine the start point position. (D point)
- ▶ Press .



(3) Determining the block modification range. (end point)

- ▶ Using Jog   determine the end point position. (E point)
- ▶ Press .

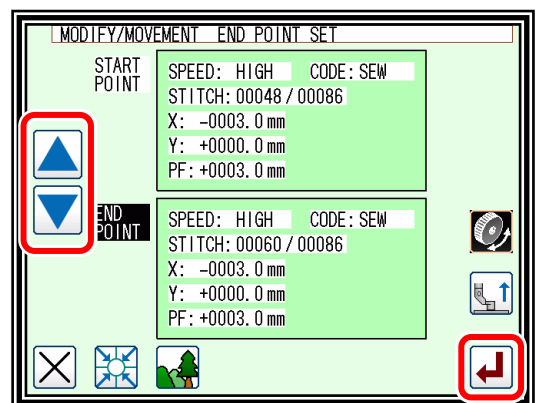

 **Caution** When the end point is determined, the presser will automatically return to the start point. Take care when the needle is lowered, etc.

(4) Setting the movement method and stitch length.

- ▶ Set the movement method.

Press Add New Stitch To Prior/Subsequent Data



- ▶ Set the stitch length.  
(Set to 3.0mm for this example.)

- ▶ Press

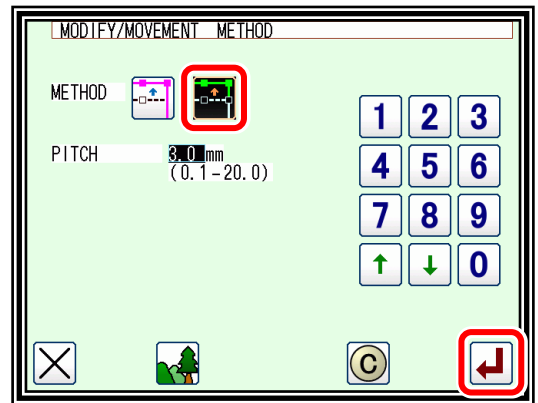

(5) Determining the movement amount.

- ▶ Using the arrow icons, determine the movement amount. (Move to the position (point D').)

- ▶ Press

(The block position will be modified.)

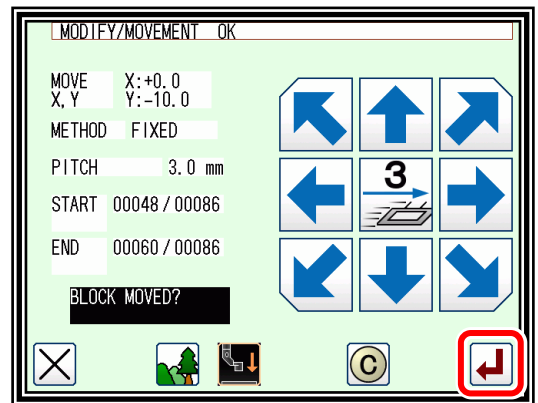

**Caution** The presser will move.  
(The presser will move to one stitch before the D point.)  
Take care when the needle is lowered, etc.

(6) Confirming after modification.

- ▶ Quit the modification mode. Press to change to the saving mode screen. It return to the standard screen after saving the data.

(When is pressed, the modifications executed last will be undone.)

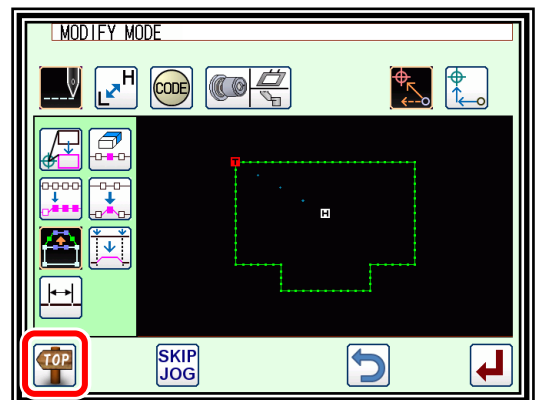

# 15. Modifying a block 1 (Linear input)

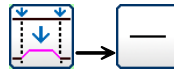

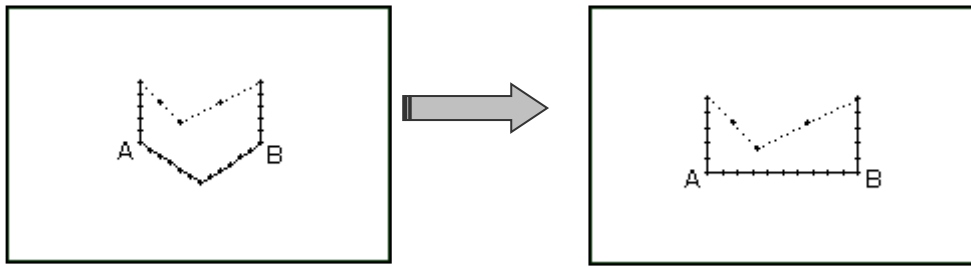

[Example] The section between the A point and B point of the following type of stitching pattern will be modified to a linear line.





## Operation details

(1) Selecting block modification.

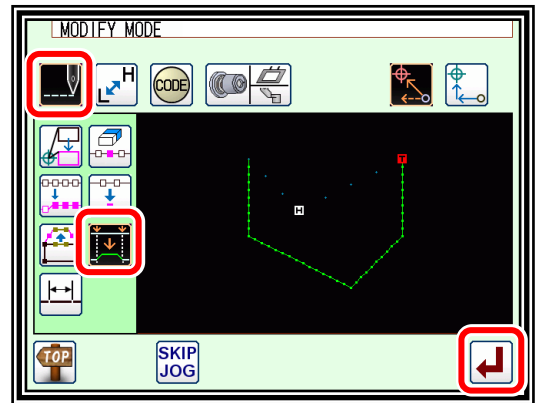
- ▶ Enter the modification mode. (Refer to Page [11] - 2)
- ▶ Press Stitch Data Change  and Block Modify .
- ▶ Press  to open the next screen.



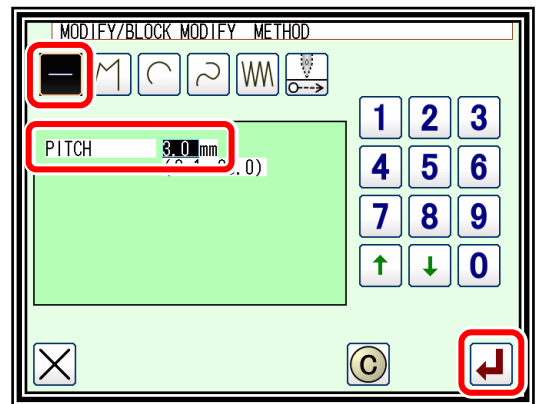

(2) Selecting the input type and the stitch length.

- ▶ Press Linear .
- ▶ Set the stitch length. (Set to 3.0mm for this example.)
- ▶ Press  to set the data.



(3) Determining the block modification range. (start point)

- ▶ Using Jog   determine the start point position. (A point)
- ▶ Press .

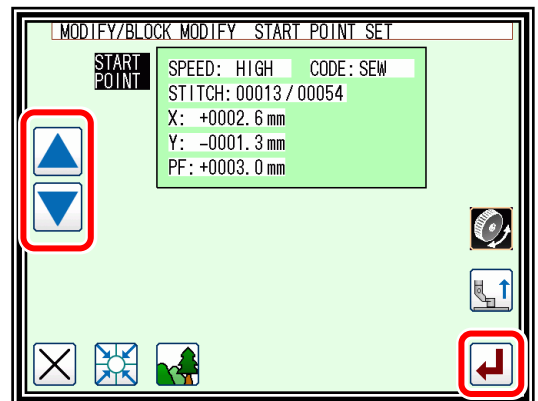

(4) Determining the block modification range. (end point)

▶ Using Jog   determine the end point position. (B point)

▶ Press .

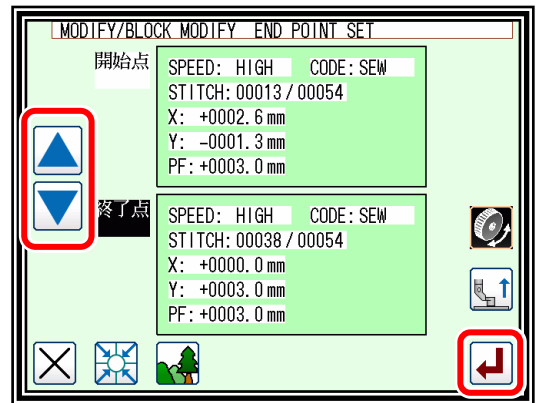

 **Caution** When the end point is determined, the work holder will automatically return to the start point. Take care when the needle is lowered, etc.



(5) Confirming the data creation.

▶ Press .

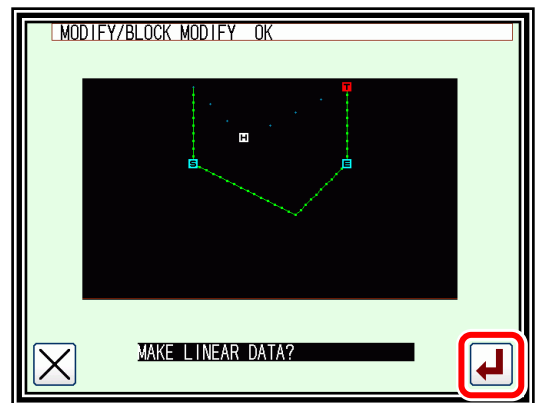
(The block position will be modified.)



(6) Confirming the modified data.

▶ Quit the modification mode. Press  to change to the saving mode screen. It return to the standard screen after saving the data.  
(When  is pressed, the modifications executed last will be undone.)

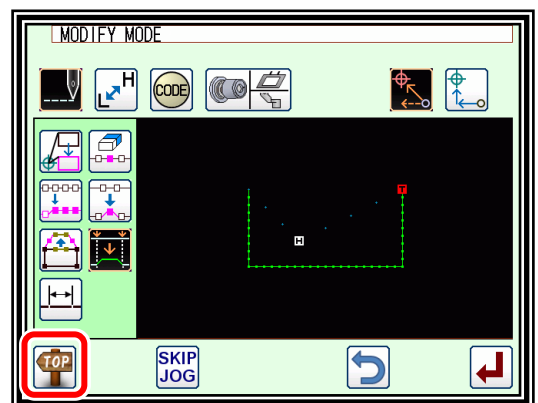

**Note**

1. When arc modification is selected for block modification: Arc modification will be executed just by indicating one point in the designated range.
2. When linear modification is selected for block modification: The modification range will be connected with linear lines.
3. If the block to be modified contains code data, the code data will be deleted.
4. The block modification start point and end point are explained below.

■ For modification other than feed data modification

The start point can be designated when the stitch is stitching data.

The end point can be designated when the section before the stitch is stitching data.

(Refer to following illustration.)

(The data between the start point and end point is irrelevant. However, the feed data between the start point and end point will be changed to stitching data.)

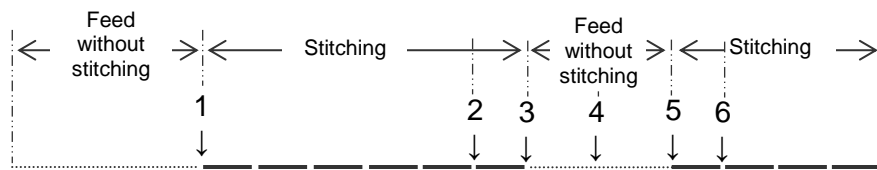

Start point	End point	Designation validity
1	- 2	Valid (OK)
1	- 3	Valid (OK)
1	- 4	Invalid (NG) ... Prior section is feed data
1	- 5	Invalid (NG) ... Prior section is feed data
1	- 6	Valid (OK)

■ For feed data modification

The start point can be designated when the stitch is stitching data or feed data.

The end point can be designated when the section before the stitch is stitching data or feed data.

(The data between the start point and end point is irrelevant.)

## 16. Modifying a block 2 (Broken line, arc, curve input)

Methods for designating the modification position with the jog icons. (This is handy when using the modification origin data as a reference.)

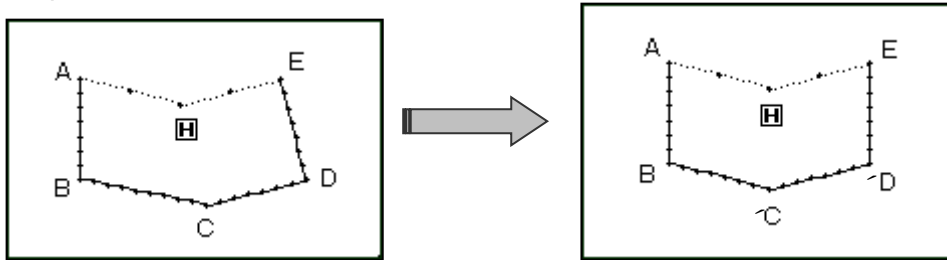

[Example] The C point and D point in the following type of data are each modified to the C' point and D' point.



### Operation details

(1) Selecting block modification.

▶ Enter the modification mode. (Refer to Page [11] - 2)

▶ Press Stitch Data Change  and Block Modify .

▶ Press  to open the next screen.

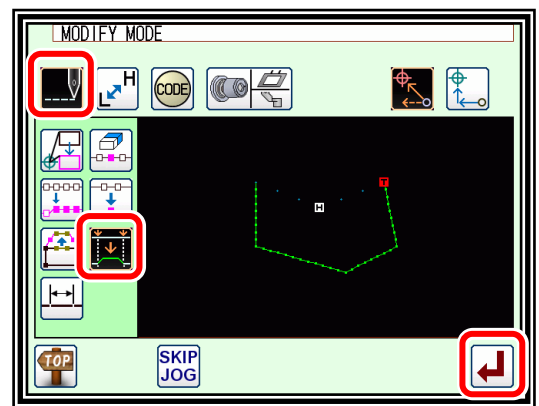

(2) Selecting the input type and the stitch length.

▶ In this case, press Broken Line .

▶ Set the stitch length. (Set to 3.0mm for this example.)

▶ Press  to set the data.

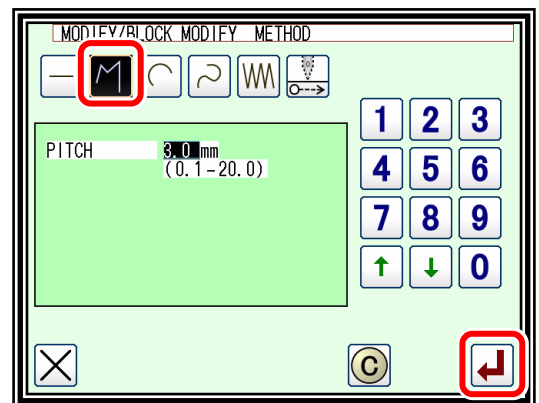

(3) Determining the block modification range. (start point)

▶ Using Jog   determine the start point position. (B point)

▶ Press .

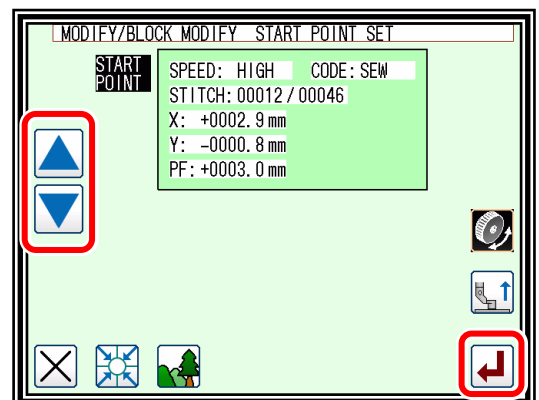

(4) Determining the block modification range. (end point)

► Using Jog   determine the end point position. (E point)



► Press Jog Validity 

► Press 

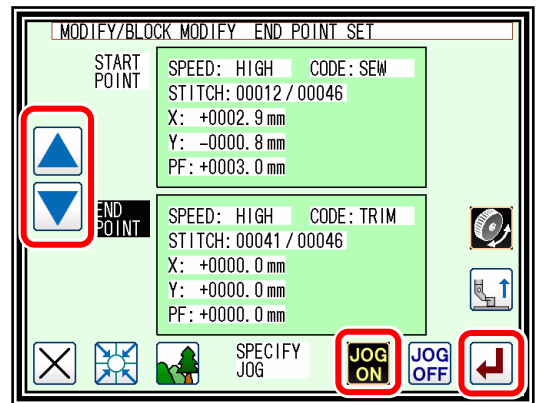
 **Caution** When the end point is determined, the work holder will automatically return to the start point. Take care when the needle is lowered, etc.



(5) Moving and setting the modification origin jog position.

► Using Jog   move to the position to be modified. (C point in this example.)

► Press 

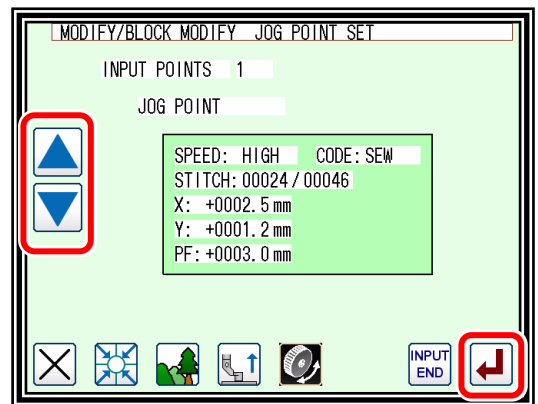

(6) Moving from the modification origin jog position to the modification position, and setting the data.



► Press the arrow icons and modify the position. (Move to the 'C' point in this example.)

► Press 

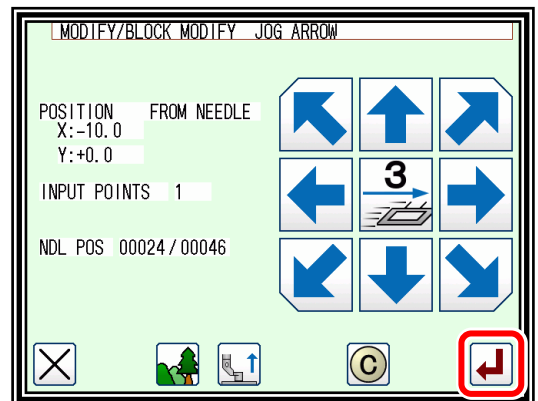
 **Caution** The work holder will automatically return to the modification origin jog position (Needle position specified at (5.)). Take care when the needle is lowered, etc.



(7) Moving and setting the modification origin jog position.

► Using Jog   move to the position to be modified. (D point in this example.)

► Press 

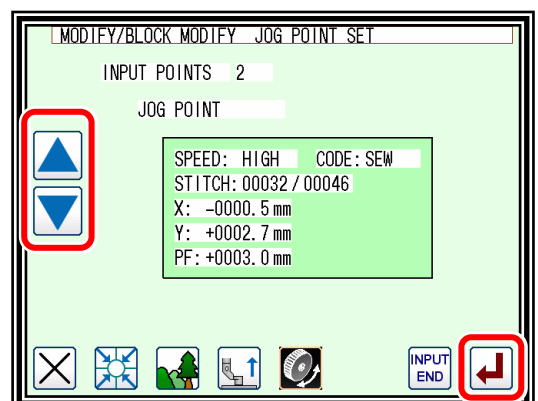

(8) Moving from the modification origin jog position to the modification position, and setting the data.

▶ Press the arrow icons and modify the position.  
(Move to the D' point in this example.)

▶ Press .

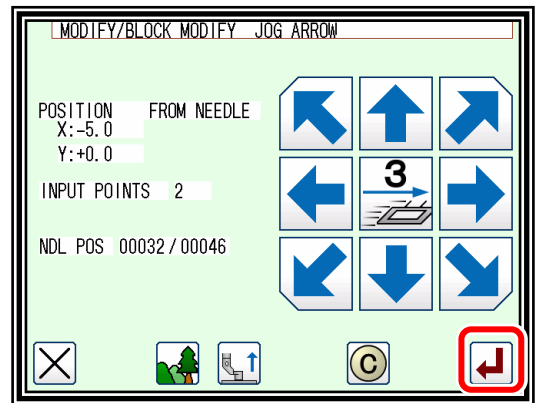

**Caution** The work holder will automatically return to the modification origin jog position (Needle position specified at (5.)). Take care when the needle is lowered, etc.

(9) Quitting position modification.

▶ After determining all modification positions, press .

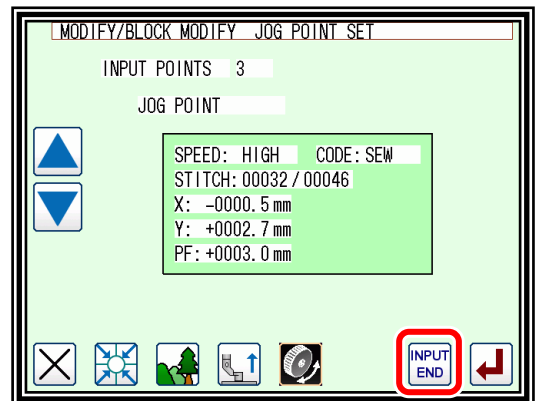

(10) Confirming the data creation.



▶ To create the data, press .

(The block position will be modified.)

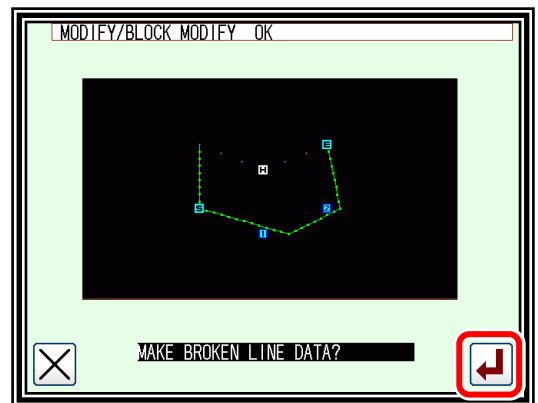
**Caution** The work holder will automatically return to the start point. Take care when the needle is lowered, etc.



(11) Confirming the modified data.

▶ Quit the modification mode. Press  to change to the saving mode screen. It return to the standard screen after saving the data.  
(When  is pressed, the modifications executed last will be undone.)

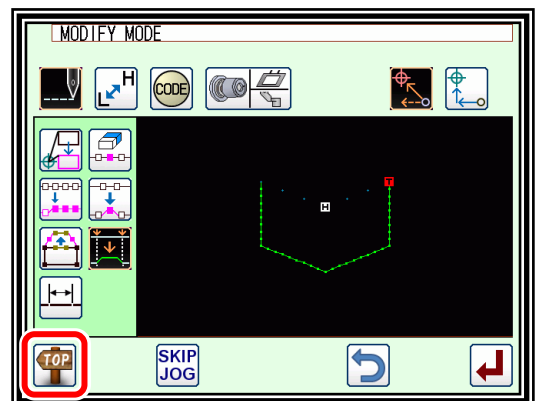



■ Designating the modification position without using jog icons (Handy for newly creating data.)

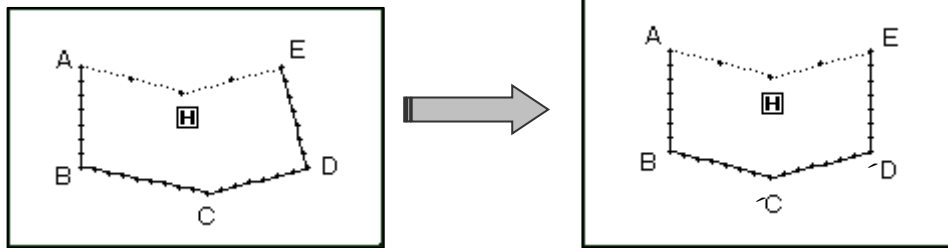

[Example] The C point and D point in the following type of data are each modified to the C' point and D' point.



### Operation details

(1) Selecting block modification.

▶ Enter the modification mode. (Refer to Page [11] - 2)

▶ Press Stitch Data Change  and Block Modify .

▶ Press  to open the next screen.

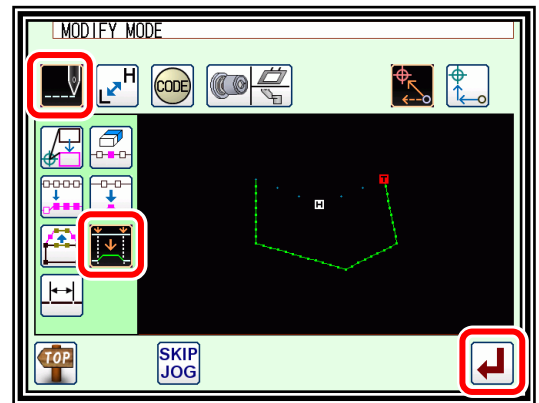

(2) Selecting the input type and the stitch length.

▶ In this case, press Broken Line .

▶ Set the stitch length. (Set to 3.0mm for this example.)

▶ Press  to set the data.

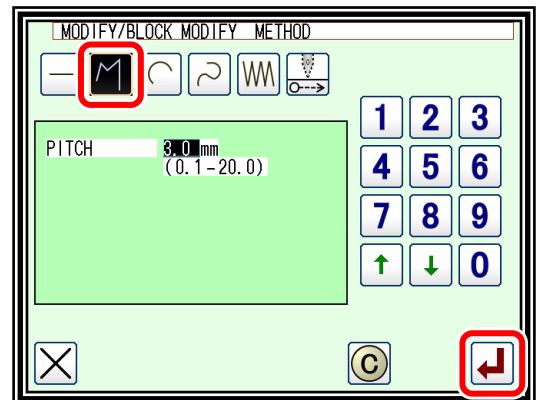



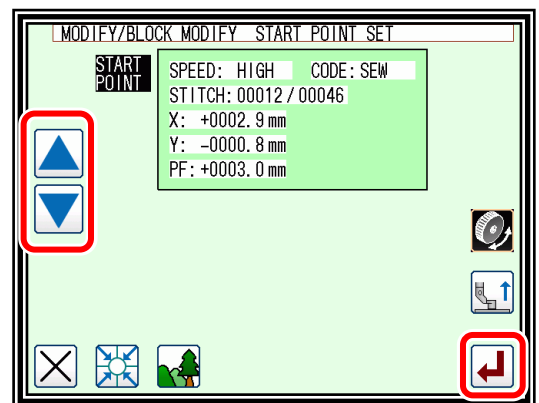

(3) Determining the block modification range. (start point)

▶ Using Jog   determine the start point position. (B point)

▶ Press .



(4) Determining the block modification range.

- ▶ Using Jog   determine the start point (B point) and end point. (E point).
- ▶ Press Jog Validity .
- ▶ Press .

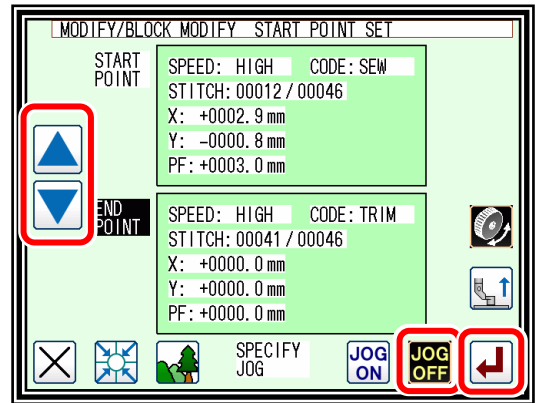



 **Caution** When the end point is determined, the work holder will automatically return to the start point. Take care when the needle is lowered, etc.

(5) Moving and determining the modification position.

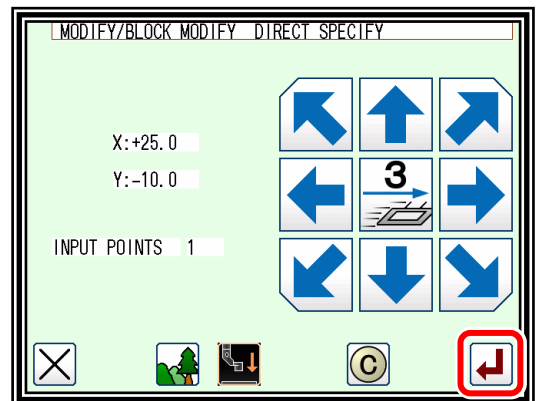
- ▶ Using the arrow icons, modify the position. (Move to C' point in this example.)
- ▶ Press .



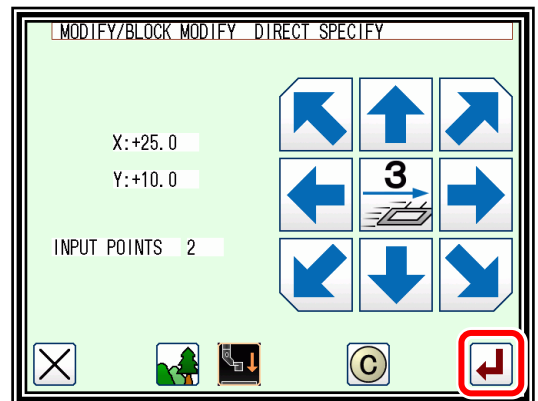

(6) Moving and determining the modification position.

- ▶ Using the arrow icons, modify the position. (Move to D' point in this example.)
- ▶ Press .
- ▶ press  again.





(7) Confirming the data creation.

- ▶ To create the data, Press .
- (The block position will be modified.)

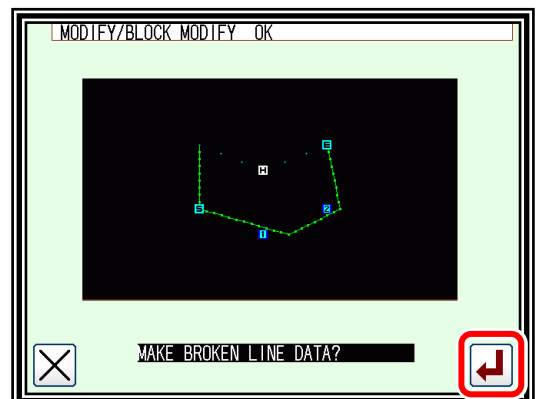
 **Caution** The work holder will automatically return to the start point. Take care when the needle is lowered, etc.



(8) Confirming the modified data.

- ▶ Quit the modification mode. Press  to change to the saving mode screen. It return to the standard screen after saving the data.
- (When  is pressed, the modifications executed last will be undone.)

## 17. Modifying a block 3 (Zigzag input)

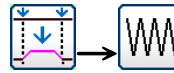

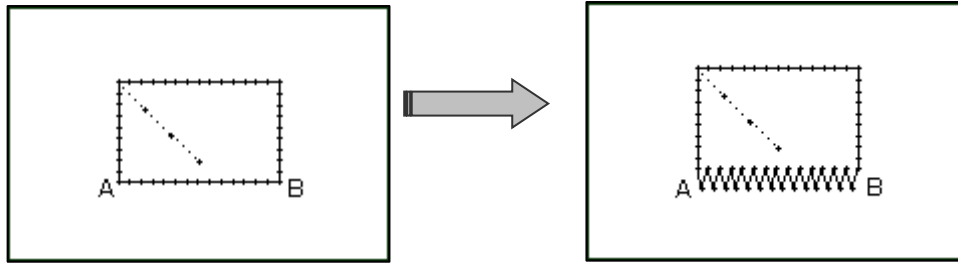

[Example] The section between the A point and B point in the following type of stitching data is modified to a zigzag pattern.





### Operation details

(1) Selecting block modification.

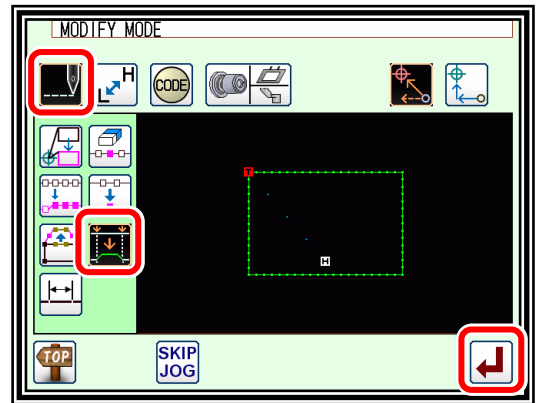
- ▶ Enter the modification mode. (Refer to Page [11] - 2)
- ▶ Press Stitch Data Change  and Block Modify .
- ▶ Press  to open the next screen.



(2) Selecting the input type.

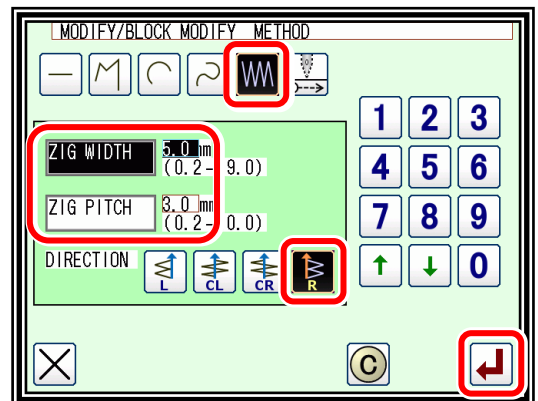

- ▶ Press Zigzag .
- ▶ Set the deflection width, feed amount and creation direction. Set the deflection width to 5.0mm, feed amount to 3.0mm, and the creation direction to right (R).
- ▶ Press  to set the data.



(At this time, if  is pressed, the deflection width and feed amount settings will be canceled.)

**Note** Refer to page [7] - 36 "12.Zigzag stitching (with overlap back tacking)" for details on the deflection width, feed amount and creation direction.

(3) Determining the block modification range. (start point)

- ▶ Using Jog   determine the start point position. (A point)
- ▶ Press .

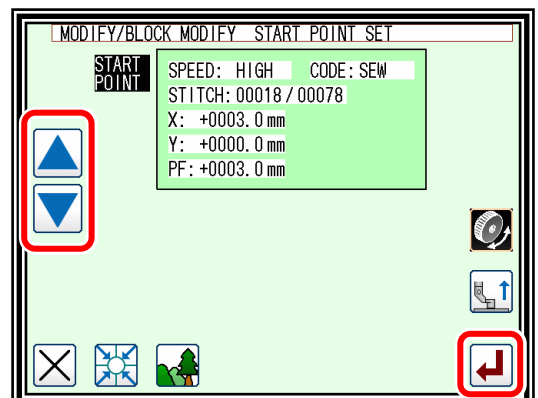

(4) Determining the block modification range. (end point)

► Using Jog   determine the end point position. (B point)

► Press .

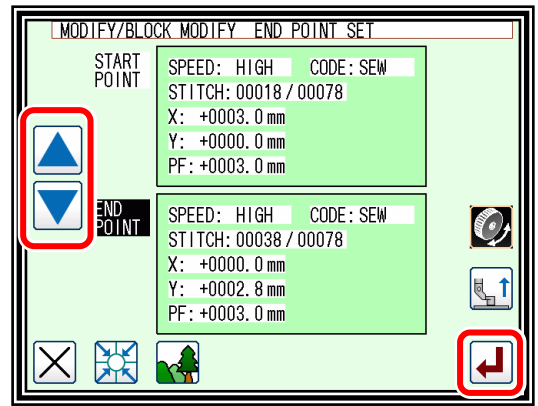

 **Caution** When the end point is determined, the work holder will automatically return to the start point. Take care when the needle is lowered, etc.



(5) Confirming the data creation.

► To create the data, press .

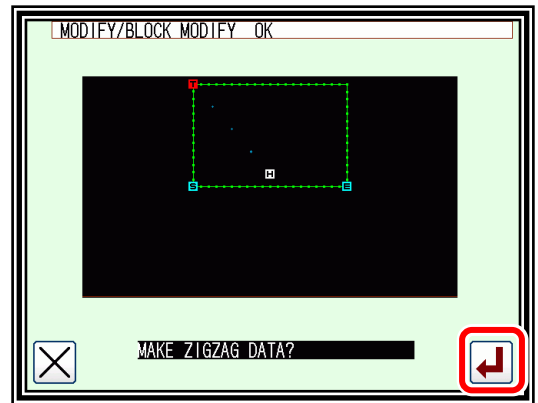
(The block position will be modified.)



(6) Confirming the modified data.

► Quit the modification mode. Press  to change to the saving mode screen. It return to the standard screen after saving the data.  
(When  is pressed, the modifications executed last will be undone.)

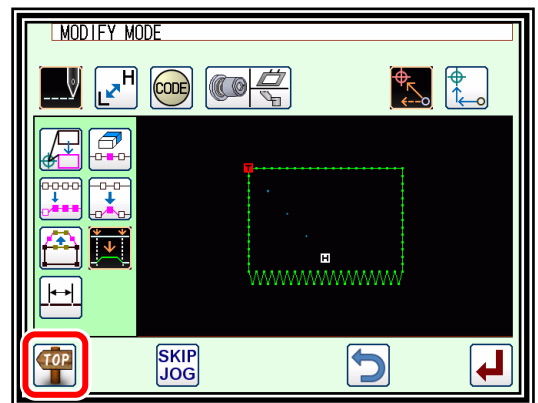

# 18. Modifying a block 4 (Changing the feed data)

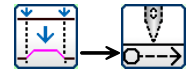

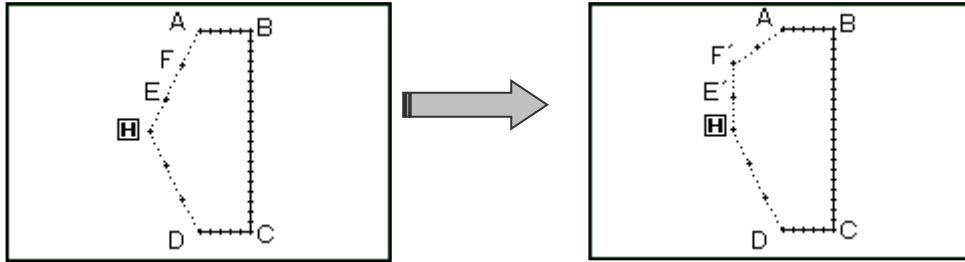

Methods for designating the modification position with the jog icons.  
 (This is handy when using the modification origin data as a reference.)

[Example] The E point and F point in the following type of data are each modified to the E' point and F' point.





## Operation details

(1) Selecting block modification.

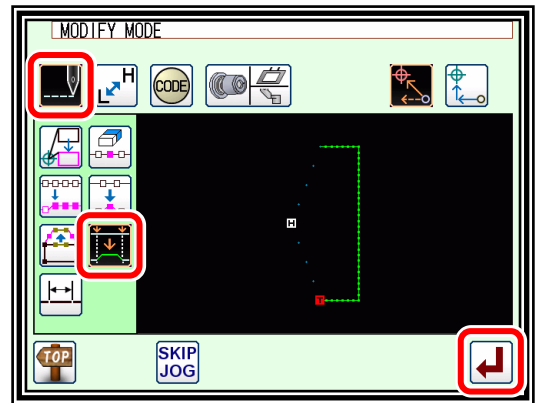
- ▶ Enter the modification mode. (Refer to Page [11] - 2)
- ▶ Press Stitch Data Change  and Block Modify .
- ▶ Press  to open the next screen.



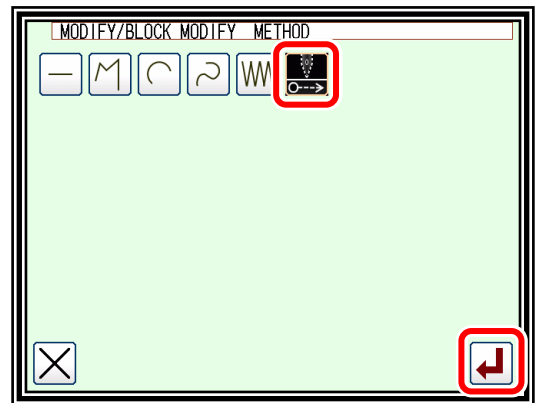

(2) Selecting the input type.

- ▶ Press Feed data .
- ▶ Press  to set the data.





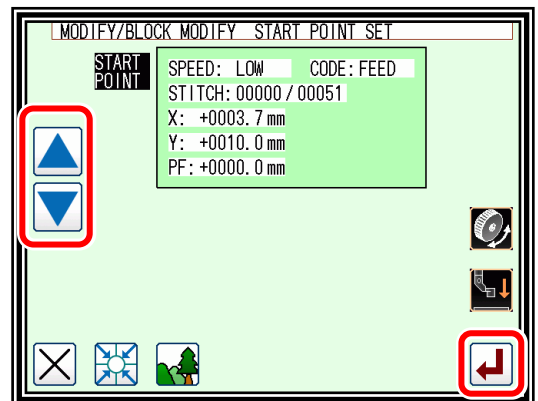

(3) Determining the block modification range. (start point)

- ▶ Using Jog   determine the start point position. (Home position)
- ▶ Press .



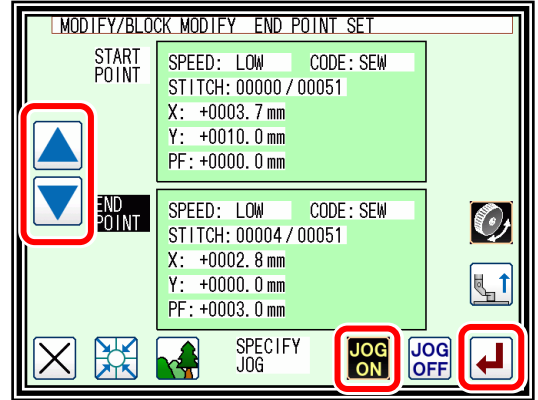

(4) Determining the block modification range. (end point)

- ▶ Using Jog   determine the end point position. (A point)
- ▶ Press Jog Validity .
- ▶ Press .



 **Caution** When the end point is determined, the work holder will automatically return to the start point. Take care when the needle is lowered, etc.

(5) Moving and setting the modification origin jog position.

- ▶ Using Jog   move to the position to be modified. (E point in this example.)
- ▶ Press .

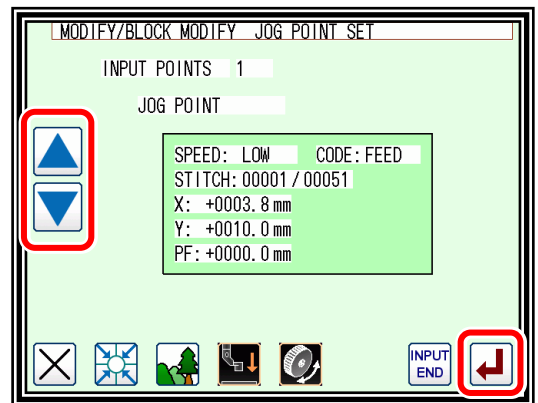



(6) Moving from the modification origin jog position to the modification position, and setting the data.

- ▶ Press the arrow icons and modify the position. (Move to the E' point in this example.)
- ▶ Press .

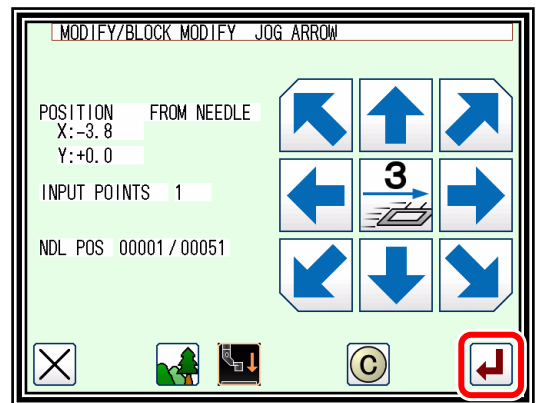
 **Caution** The work holder will automatically return to the modification origin jog position. Take care when the needle is lowered, etc.



(7) Moving and setting the modification origin jog position.

- ▶ Using Jog   move to the position to be modified. (F point in this example.)
- ▶ Press .

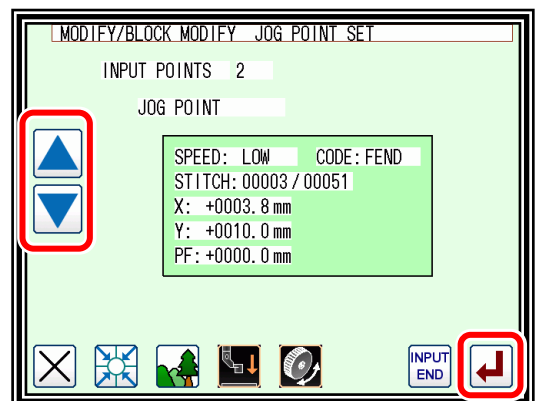

(8) Moving from the modification origin jog position to the modification position, and setting the data.

▶ Press the arrow icons and modify the position.  
(Move to the F' point in this example.)

▶ Press .

 **Caution** The work holder will automatically return to the modification origin jog position. Take care when the needle is lowered, etc.

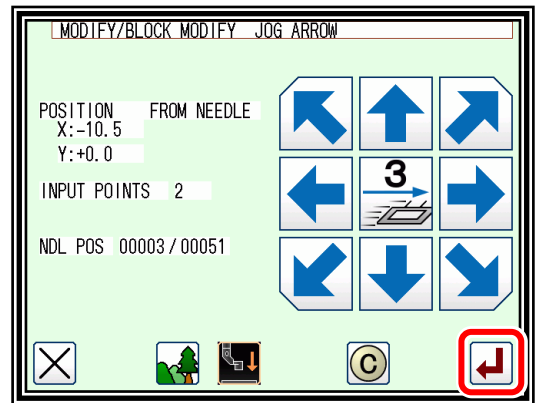

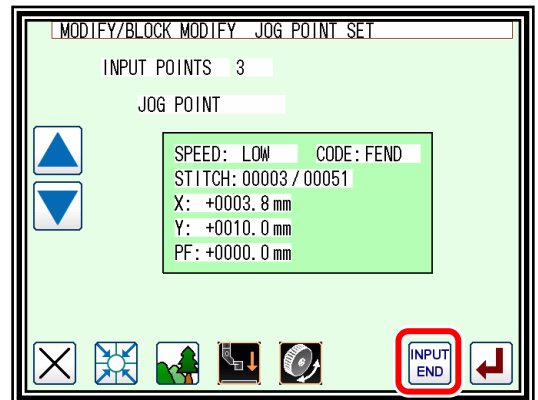

(9) Quitting position modification.

▶ After determining all modification positions, press .





(10) Confirming the data creation.

▶ Press   
(The block position will be modified.)

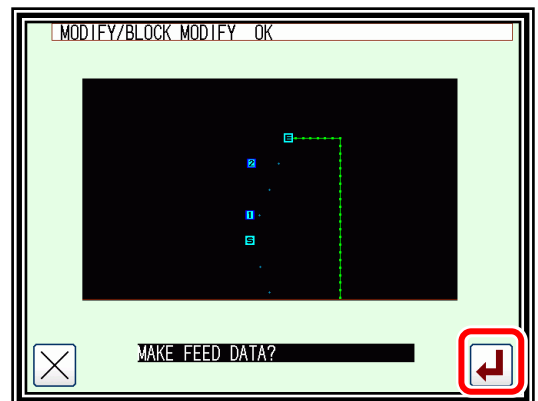
 **Caution** The work holder will automatically return to the start point. Take care when the needle is lowered, etc.



(11) Confirming the modified data.

▶ Quit the modification mode. Press  to change to the saving mode screen. It return to the standard screen after saving the data.  
(When  is pressed, the modifications executed last will be undone.)

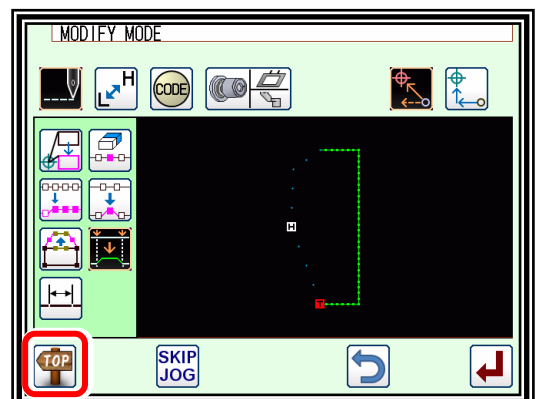

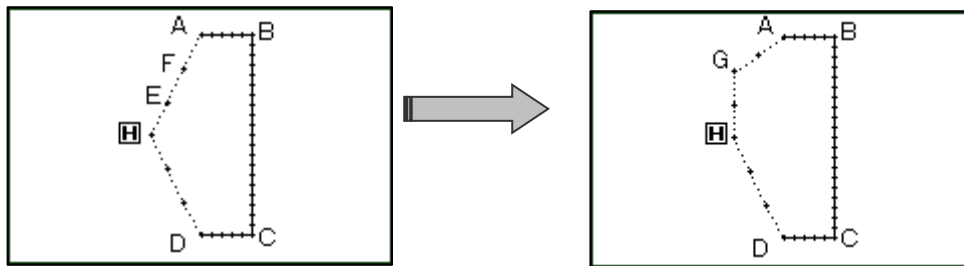

## ■ Designating the modification position without using jog icons (Handy for newly creating data.)

[Example] The E point and F point in the following type of stitching data will be deleted, the G point will be newly created, and the feed data will be modified.





### Operation details

(1) Selecting block modification.

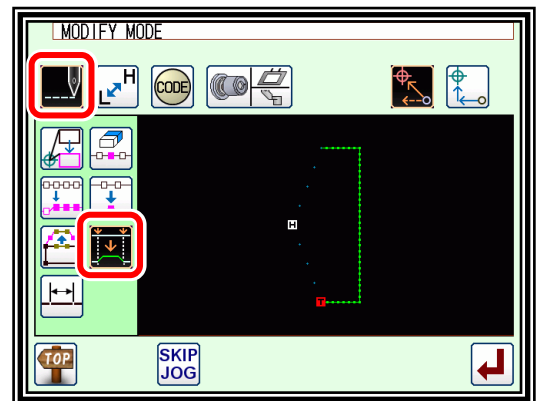
- ▶ Enter the modification mode. (Refer to Page [11] - 2)
- ▶ Press Stitch Data Change  and Block Modify .
- ▶ Press  to open the next screen.



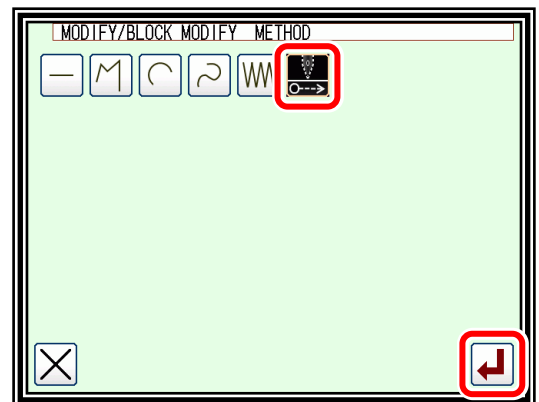

(2) Selecting the input type.

- ▶ Press Feed data .
- ▶ Press  to set the data.





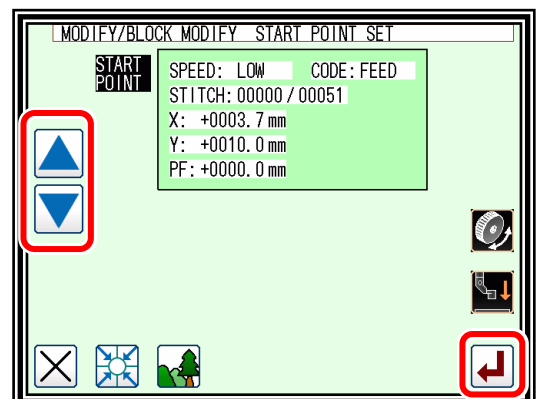

(3) Determining the block modification range. (start point)

- ▶ Using Jog   determine the start point position. (Home position)
- ▶ Press .





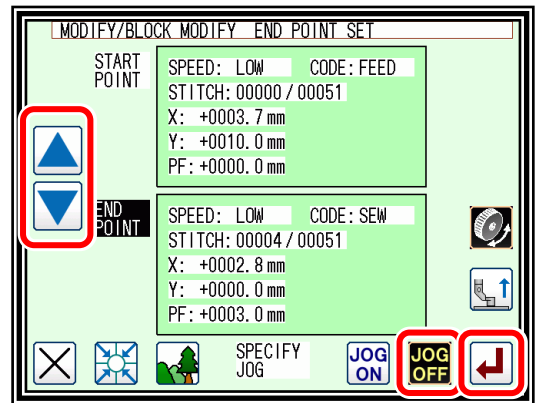

(4) Determining the block modification range.

- ▶ Using Jog   determine the start point (Home position) and end point (A point).
- ▶ Press Jog Validity .
- ▶ Press .



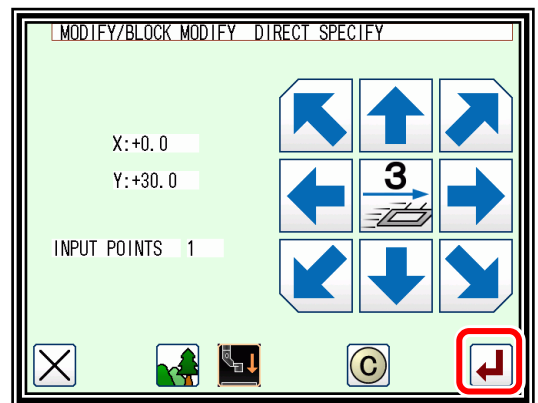

(5) Moving and determining the modification position.

- ▶ Using the arrow icons, modify the position. (Move to G point in this example.)
- ▶ Press .
- ▶ If there are several positions to be modified, repeat step 5. (The number of input points will increase.)
- ▶ When all modifications have been made, press  again.





(6) Confirming the data creation.

- ▶ Press .
- (The block position will be modified.)

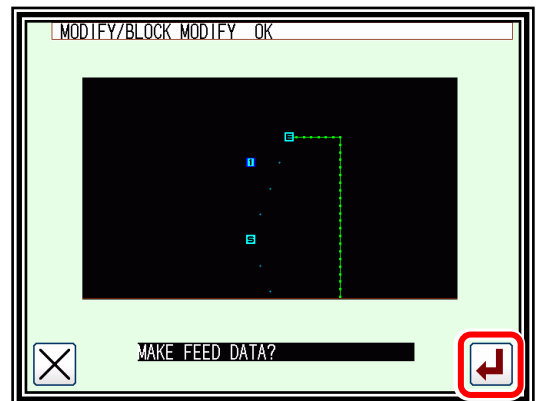
 **Caution** The work holder will automatically return to the start point. Take care when the needle is lowered, etc.



(7) Confirming the modified data.

- ▶ Quit the modification mode. Press  to change to the saving mode screen. It return to the standard screen after saving the data. (When  is pressed, the modifications executed last will be undone.)

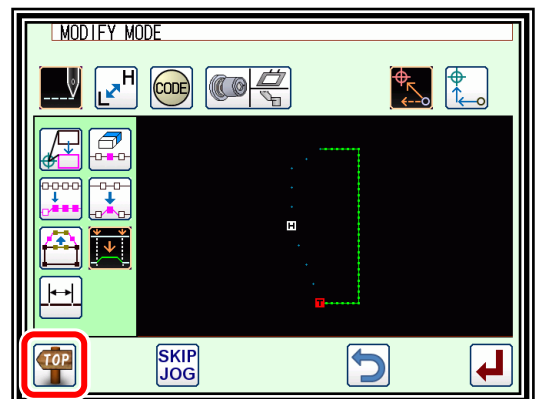

# 19. Modifying stitch length (Designated distance modification)

[Example] The stitch length between the stitching data point A and point B is modified as shown below. (3.0mm → 7.0mm)

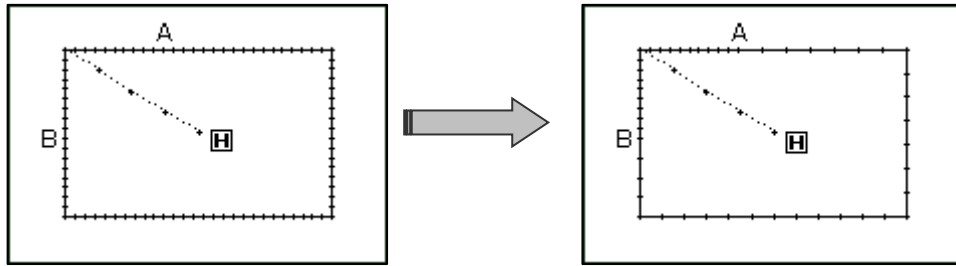

## Operation details

(1) Selecting the stitch length modification.

- ▶ Enter the modification mode. (Refer to Page [11] - 2)
- ▶ Press Stitch Data Change and Stitch length modification .
- ▶ Press to open the next screen.

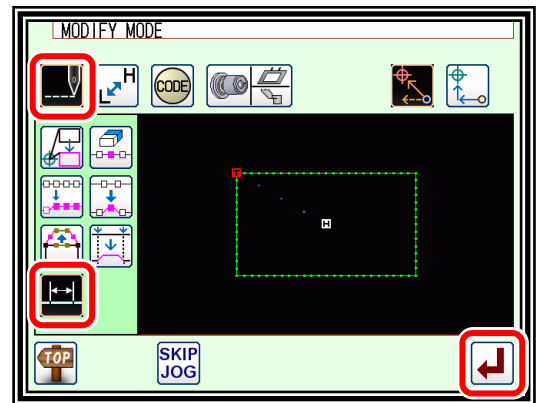

(2) Determining the modification method and the modification start position.

- ▶ Set the method.
  - : Designated distance modification.
  - : All After designated stitch.
 (In this case, press )

- ▶ Determine the position to be modified with Jog . Set to the position to start modification. (point A)
- ▶ Press .

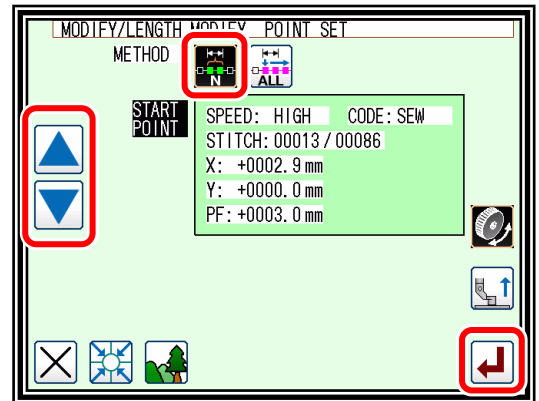

(3) Determining the modification end position.

- ▶ Determine the position to be modified with Jog . Set to the position to end modification. (point B)
- ▶ Press .

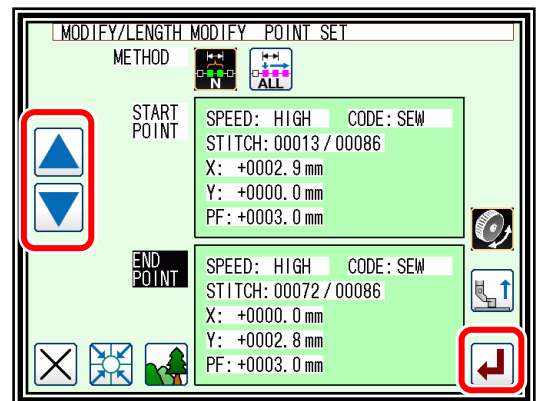

**Caution** When the end point is determined, the work holder will automatically return to the start point. Take care when the needle is lowered, etc.



(4) Setting the stitch length and confirming execution.

▶ Set the stitch length. (This will be "7.0mm" here.)

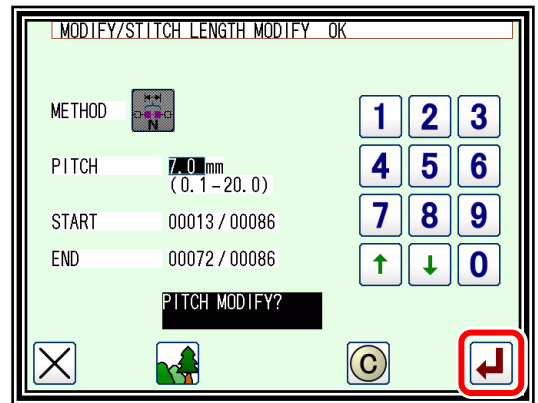
▶ Press .



(5) Confirming the modifications.

▶ Quit the modification mode. Press  to change to the saving mode screen. It return to the standard screen after saving the data.  
(When  is pressed, the modifications executed last will be undone.)

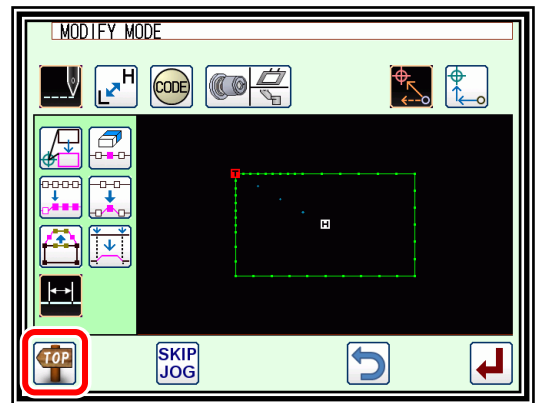

(6) Confirming with the Standard screen.

▶ The stitch length has been modified.

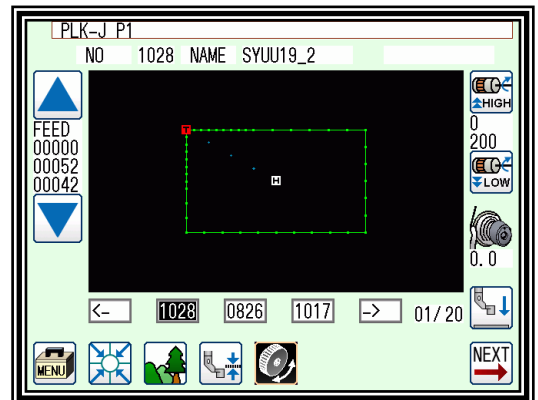

## 20. Modifying stitch length (All After designated stitch)



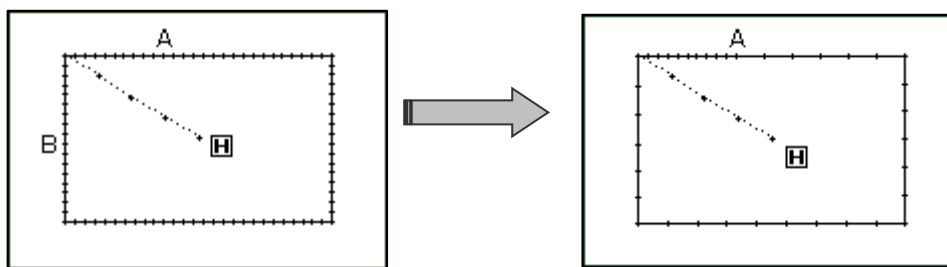

[Example] The stitch length from stitching data point A to the end of stitching is modified as shown below. (3.0mm → 9.0mm)







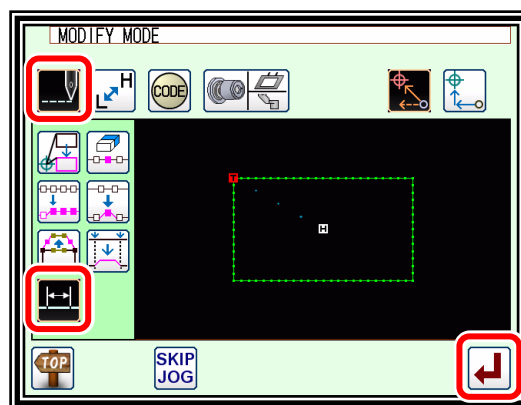

### Operation details

(1) Selecting the stitch length modification.

- ▶ Enter the modification mode. (Refer to Page [11] - 2)
- ▶ Press Stitch Data Change  and Stitch length modification .
- ▶ Press  to open the next screen.



(2) Determining the modification method and the modification start position.

- ▶ Set the method.
  -  : Designated distance modification.
  -  : All After designated stitch.
  - (In this case, press )
- ▶ Determine the position to be modified with Jog  . Set to the position to start modification. (point A)
- ▶ Press .

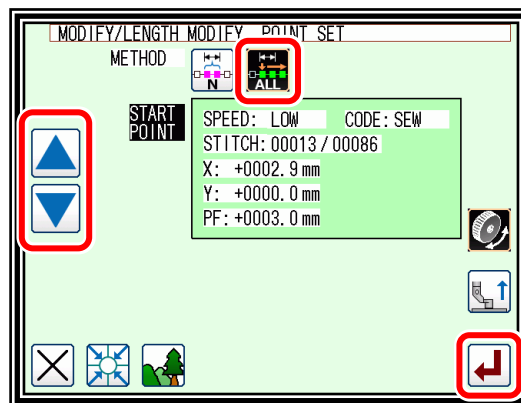

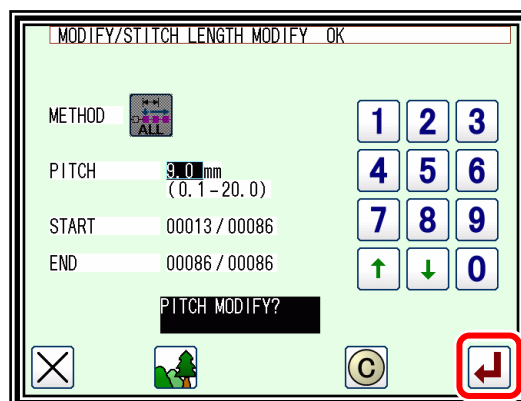

(3) Setting the stitch length and confirming execution.

- ▶ Set the stitch length. (This will be "9.0mm" here.)
- ▶ Press .



(4) Confirming the modifications.

- ▶ Quit the modification mode. Press  to change to the saving mode screen. It return to the standard screen after saving the data.  
(When  is pressed, the modifications executed last will be undone.)

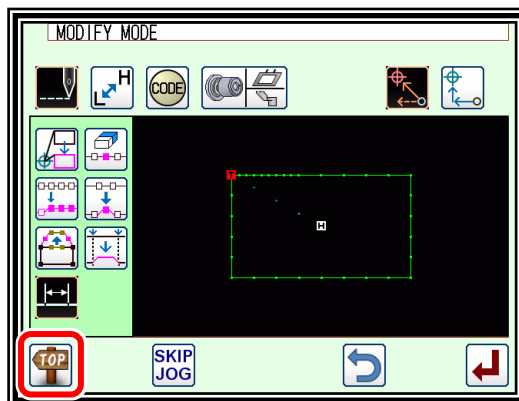

(5) Confirming with the Standard screen.

- ▶ The stitch length has been modified.

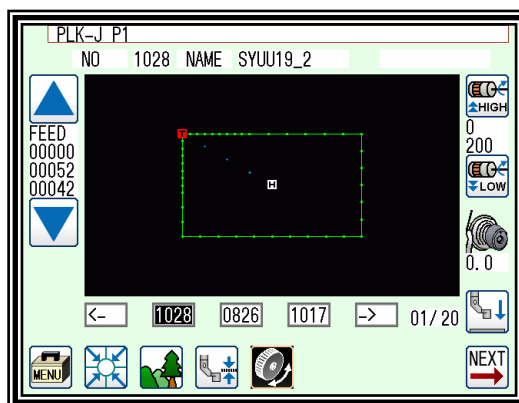

## 21. Modifying the stitching speed →

### (All sections after designated position)

[Example] The stitching speed for all sections after the B point in the following type of stitching data will be changed to medium-high speed (MD1).

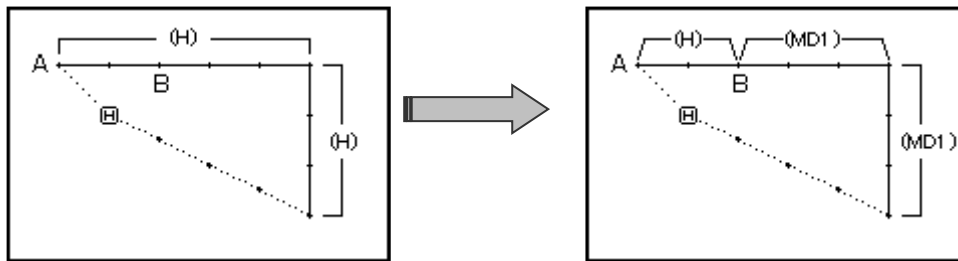

### Operation details

(1) Selecting stitching speed modification.

▶ Enter the modification mode. (Refer to Page [11] - 2)

▶ Press Stitching Speed Change .

▶ Press  to open the next screen.

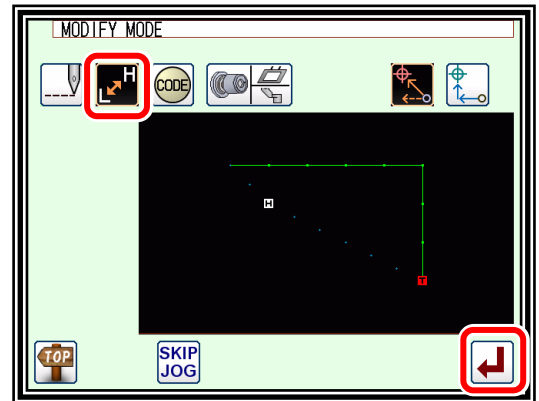



(2) Determining the modification method and the modification start position.

▶ Set the method.

 : Designated No of Stitches.

 : All After Designated Stitch.

(Press All After Designated Stitch )

▶ Using Jog   determine the start point position to be modified (B point).

▶ Press  after determining the positions.

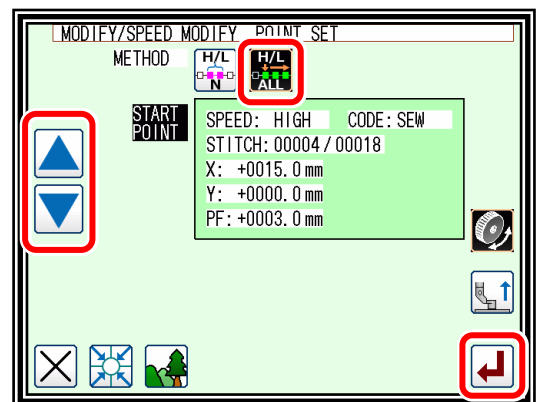

(3) Setting the speed and confirming execution.

▶ Set the new speed (MD1).

▶ Press .

(The stitching speed will be modified.)

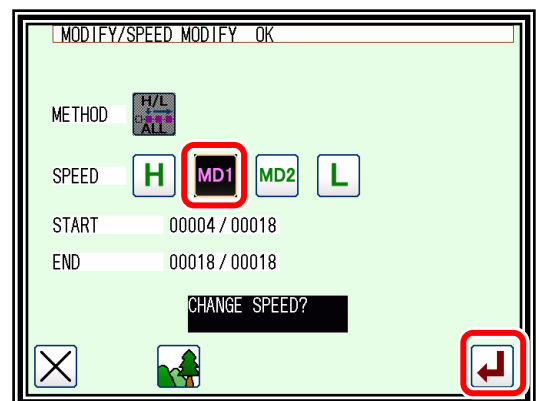

(4) Confirming the modifications.

▶ Quit the modification mode. Press  to change to the saving mode screen.

It returns to the standard screen after saving the data.

## 22. Modifying the stitching speed (N stitches after designated position)

[Example] The stitching speed for three stitches from the B point to the C point in the following type of stitching data will be changed to medium-high speed (MD1).

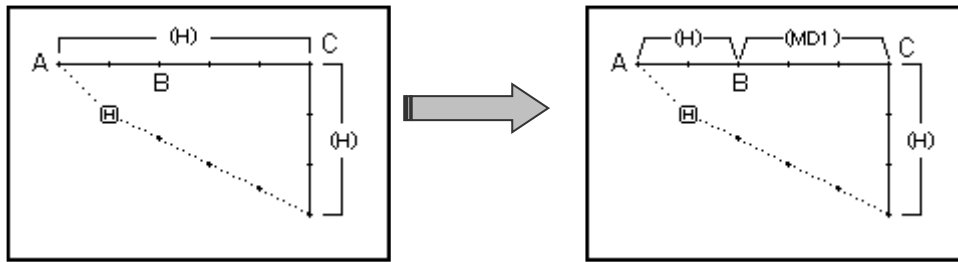

### Operation details

(1) Selecting stitching speed modification.

- ▶ Enter the modification mode. (Refer to Page [11] - 2)
- ▶ Press Stitching Speed Change
- ▶ Press to open the next screen.

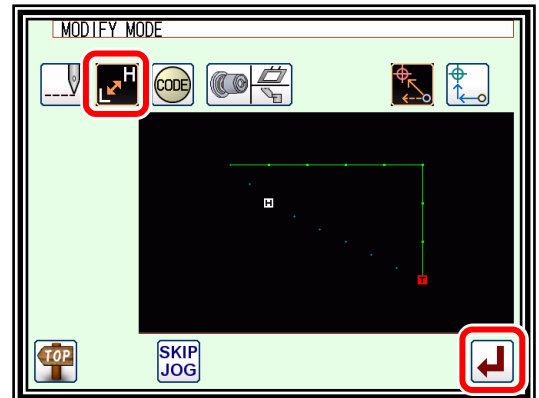

(2) Determining the modification position and the modification range. (start point)

- ▶ Press N Stitches Change after Modified Stitch
- ▶ Using Jog determine the start point position to be modified. (B point)
- ▶ Press after determining the positions.

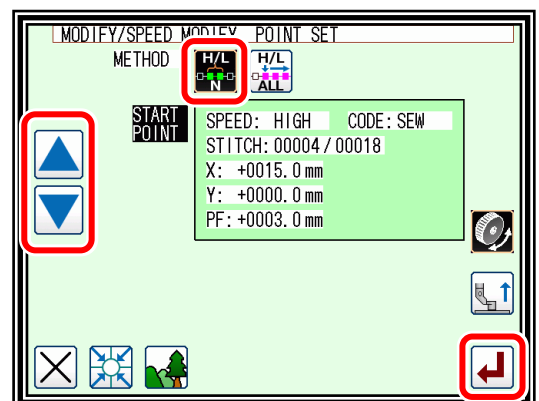

(3) Determining the modification range. (end point)

- ▶ Using Jog determine the end point position to be modified. (C point)
- ▶ Press after determining the positions.

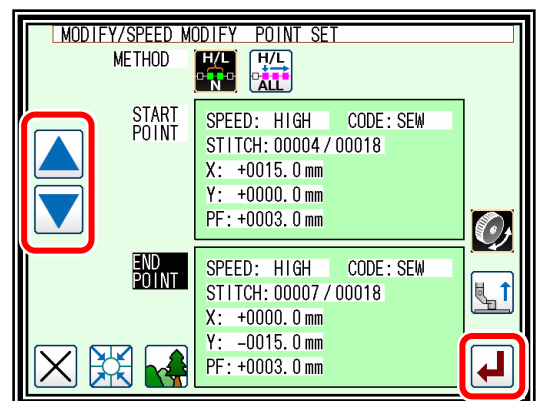

**Caution** When the end point is determined, the work holder will automatically return to the start point. Take care when the needle is lowered, etc.

(4) Setting the speed and confirming execution.

▶ Set the new speed (MD1).

▶ Press .

(The stitching speed will be modified.)

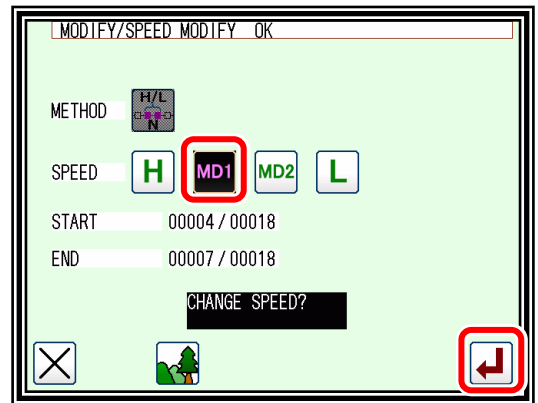

(5) Confirming the modifications.

▶ Quit the modification mode. Press  to change to the saving mode screen. It return to the standard screen after saving the data.

(When  is pressed, the modifications executed last will be undone.)

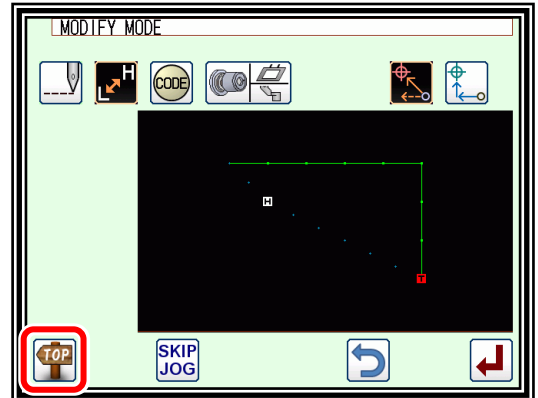

**Note** As the speed and stitch length can not be confirmed on the standard screen, it is recommended to check the part to be changed on the image display screen in (4).

As a confirmation method again, you can check the status by selecting the speed correction screen and moving the locus of the pattern with JOG on the screen of (2).

JOG

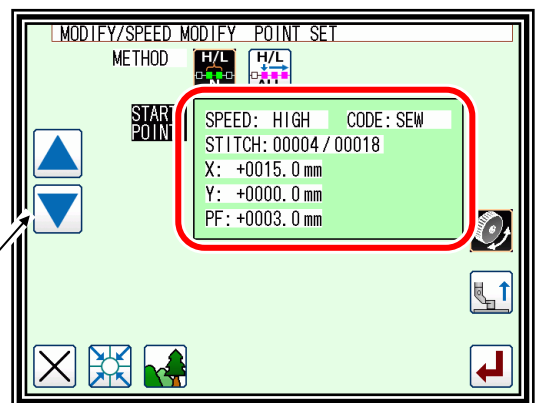

In addition, you can shift to the input screen with existing data from the pattern input screen and move the locus of the pattern with JOG to check the state.

JOG

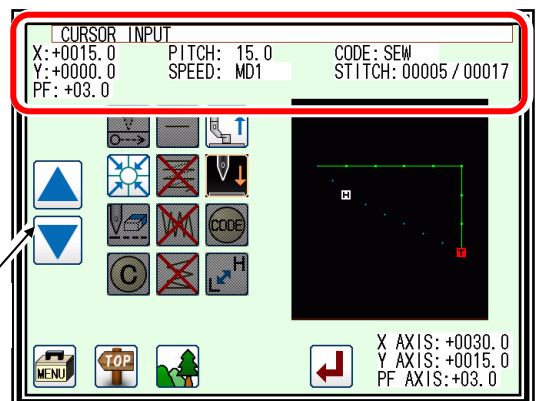



## 23. Modifying code data (Adding code data)



**Note** Refer to "Code data input" for a list of code data. page [7] - 22

[Example] The needle UP halt code (USTP) will be added to the D point of the following type of stitching data.

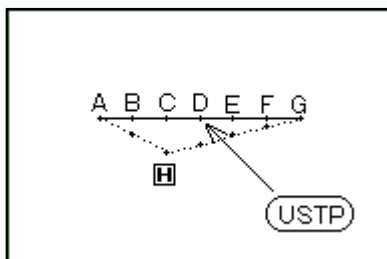



### Operation details

(1) Selecting code data addition.

▶ Enter the modification mode. (Refer to Page [11] - 2)

▶ Press Code Data Change ,

and then press Code Data Add .

▶ Press  to open the next screen.

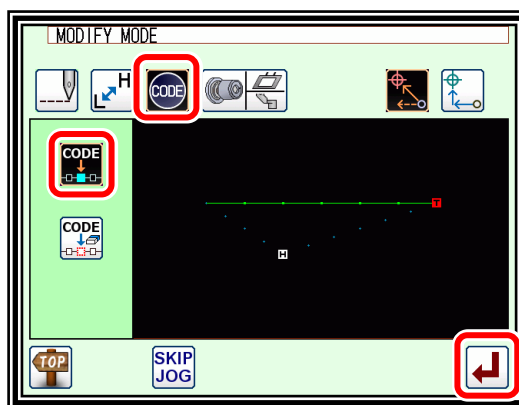

(2) Determining the code addition position.

▶ Using Jog   determine the position to add the code. (D point)

▶ Press  after determining the position.

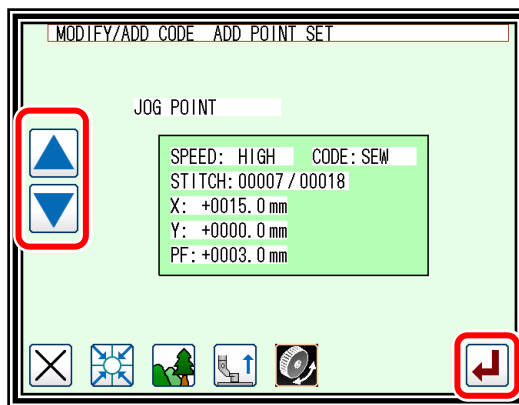

(3) Setting the code to add.

▶ Press Needle UP Halt .

▶ Press .

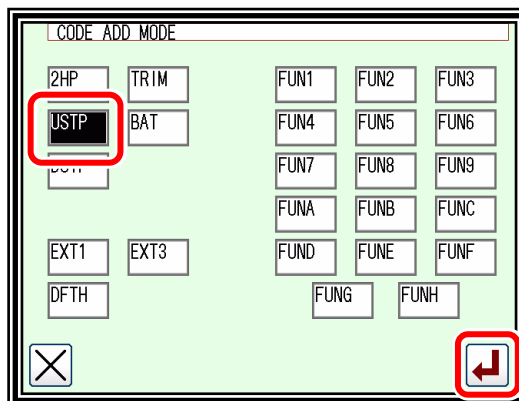

(4) Confirming execution.

▶ Press .

(The code data will be added.)



(5) Confirming the modifications.

▶ Quit the modification mode. Press  to change to the saving mode screen. It return to the standard screen after saving the data.

(When  is pressed, the modifications executed last will be undone.)

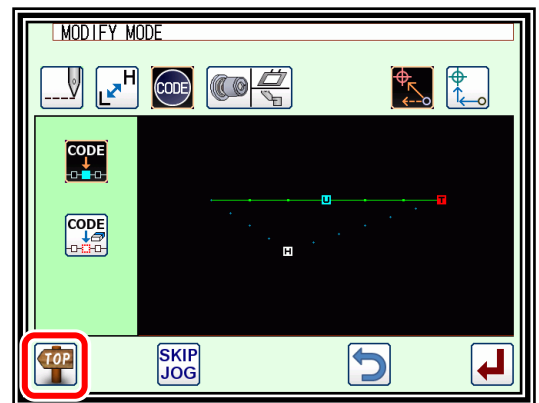

## 24. Modifying code data (Deleting code data)



[Example] The needle UP halt code (USTP) will be deleted from the D point of the following type of stitching data.

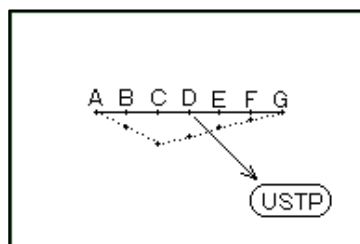



### Operation details

(1) Selecting code data deletion.

▶ Enter the modification mode. (Refer to Page [11] - 2)



▶ Press Code Data change ,

and then press Code Data Delete .

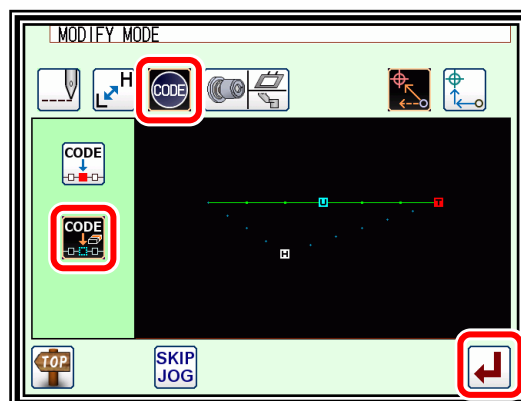
▶ Press  to open the next screen.



(2) Determining the code deletion position.

▶ Using Jog   determine the position to delete the code. (D point)  
(It can also be confirmed from the code displayed on the screen)

▶ Press  after determining the position.

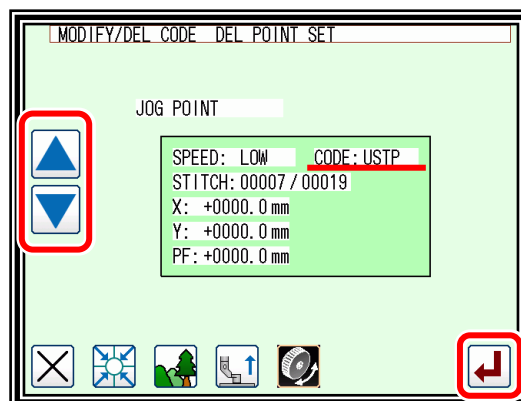

(3) Confirming execution.

▶ Press .

(The code data will be deleted.)

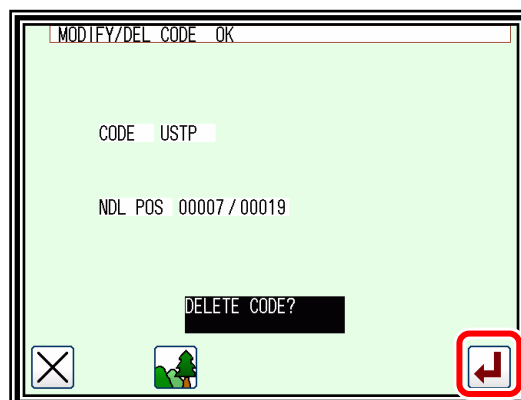

(4) Confirming the modifications.

▶ Quit the modification mode. Press  to change to the saving mode screen. It return to the standard screen after saving the data.

(When  is pressed, the modifications executed last will be undone.)

## 25. M3 feed angle width



[Note] program mode    digital tension    DTSN:"PT" only

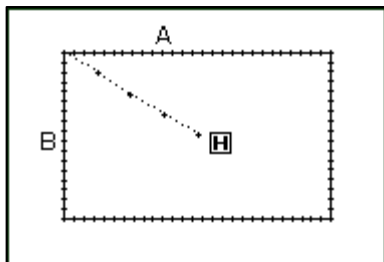



[Example] Correct feed motion of X and Y axes from point A to point B on the left sewing data

### Operation details

(1) Selecting M3 feed angle width.

▶ Enter the modification mode. (Refer to page [11] - 2)

▶ Press  to switch the display and select .

▶ Press  to open the next screen.

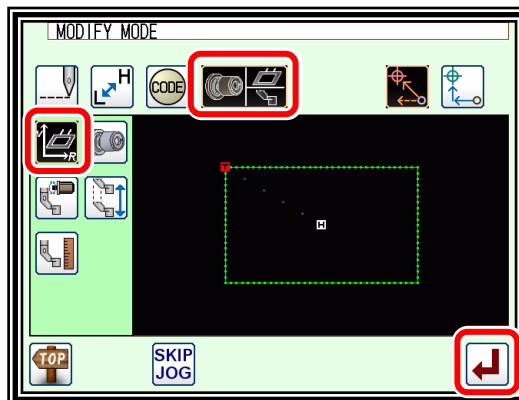

(2) Determining the range. (start point)

▶ Using Jog   determine the start point position. (A point)

▶ Press  after determining the position.

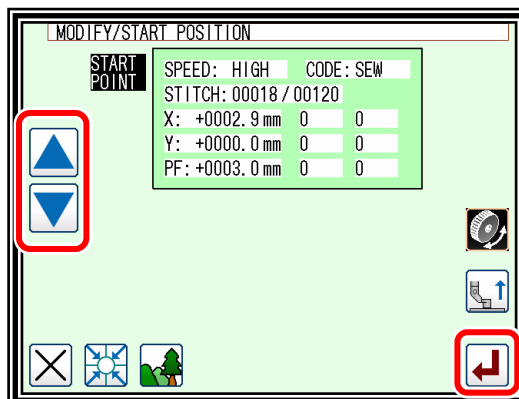

(3) Determining the range. (end point)

▶ Using Jog   determine the end point position. (B point)

▶ Press  after determining the position.

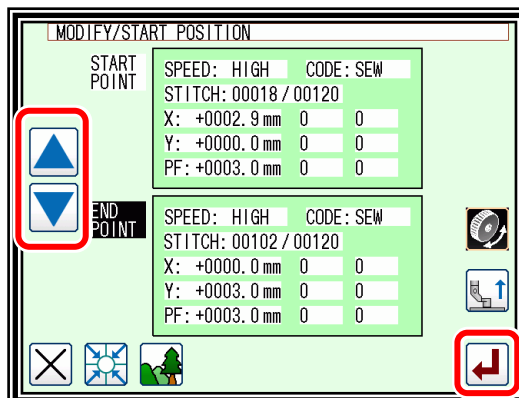

 **Caution** When the end point is determined, the work holder will automatically return to the start point. Take care when the needle is lowered, etc.



(4) Setting the M3 feed angle width and confirming execution.

▶ Select the set value from each of the X and Y axes.

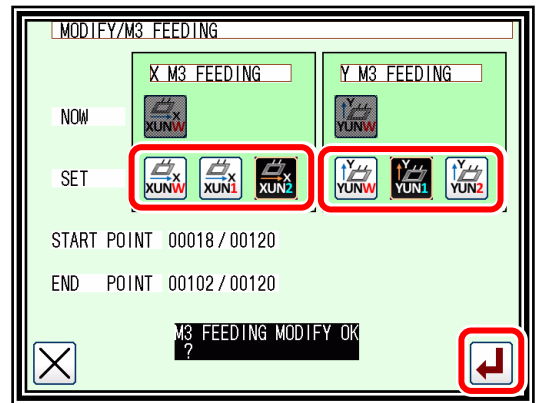
▶ Press .







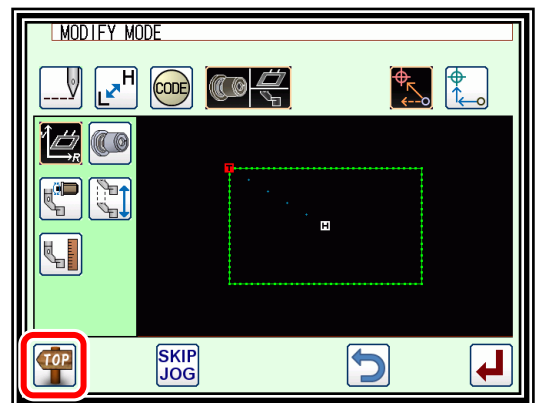

(5) Confirming the modifications.

▶ Quit the modification mode. Press  to change to the saving mode screen. It return to the standard screen after saving the data.  
(When  is pressed, the modifications executed last will be undone.)



**Note** As a confirmation of the set value, press  again in Modify sewing quality items mode.  
(It is  here)

The input screen of start point is displayed. (End point is the same)  
The track is followed in JOG, the set value is displayed.

-   code default -> 0
-   code setting 1 -> 1
-   code setting 2-> 2

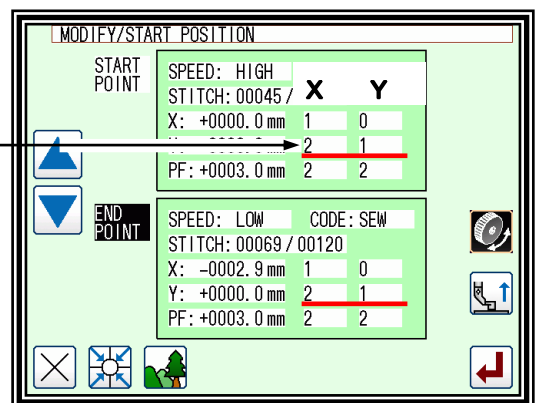

The above setting can be changed from the program mode "Feed angle".

## 26. Digital tension



**Note** Program mode Digital tension DTSN : Valid only for "PT"

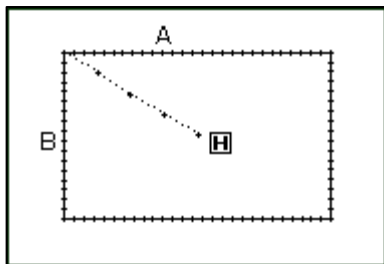



[Example] Correct tension value from point A to point B on the left sewing data.

### Operation details

#### (1) Selecting Digital tension.

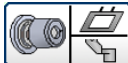
▶ Enter the modification mode. (Refer to page [11] - 2)

▶ Press  to switch the display and select .

▶ Press  to open the next screen.

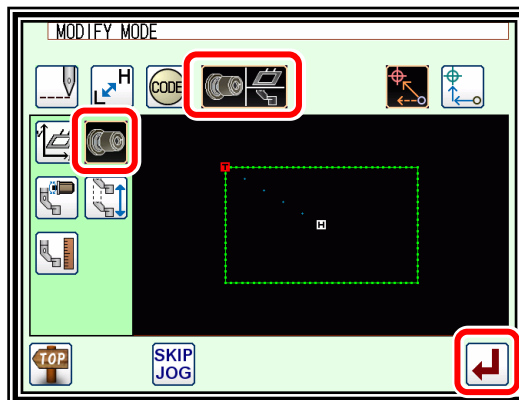

#### (2) Determining the range. (start point)

▶ Using Jog   determine the start point position. (A point)

▶ Press  after determining the position.

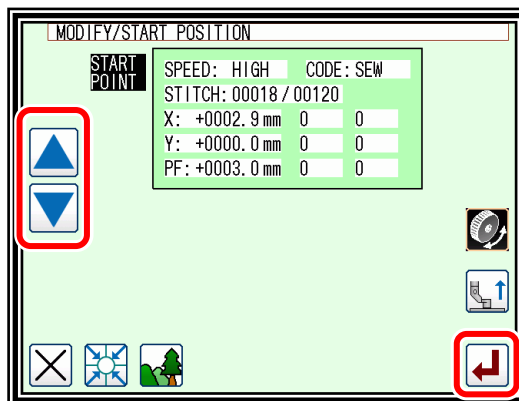

#### (3) Determining the range. (end point)

▶ Using Jog   determine the end point position. (B point)

▶ Press  after determining the position.

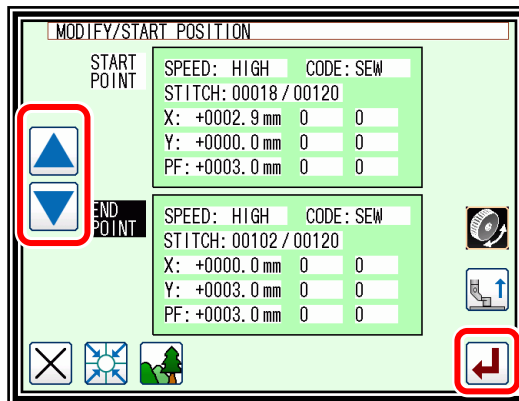

**Caution** When the end point is determined, the work holder will automatically return to the start point. Take care when the needle is lowered, etc.

(4) Setting the Digital tension and confirming execution.

- ▶ In case of set value
- ▶ After selecting from the setting value, press

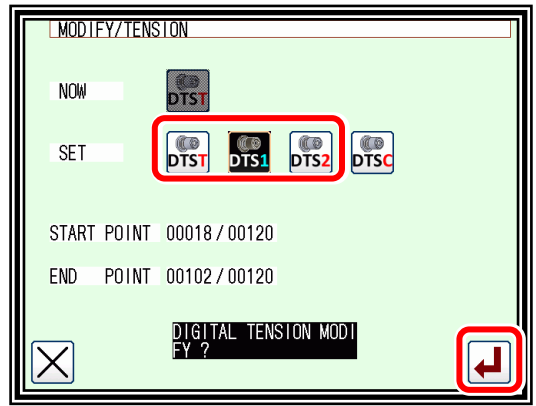

- ▶ In case of set value
- ▶ Since the manual setting screen is displayed, set the value by turning the tension itself by hand.
- ▶ After selecting from the setting value, press

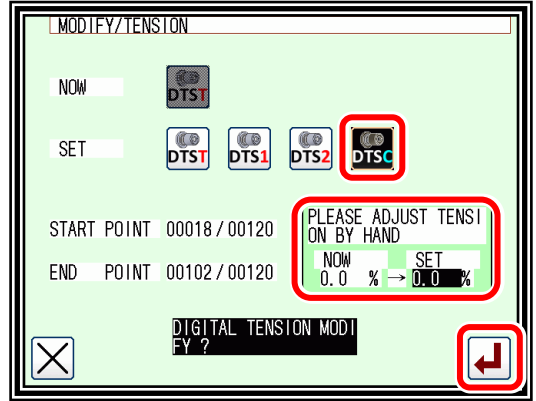

(5) Confirming the modifications.

- ▶ Quit the modification mode. Press to change to the saving mode screen. It return to the standard screen after saving the data.  
(When is pressed, the modifications executed last will be undone.)



**Note** As a confirmation of the set value, press again in Modify sewing quality items mode.  
(It is here)

The input screen of start point is displayed. (End point is the same)

The track is followed in JOG, the set value is displayed.

- code default -> 0
- code setting 1 -> 1
- code setting 2 -> 2
- code custom-> 3

Manually set value"

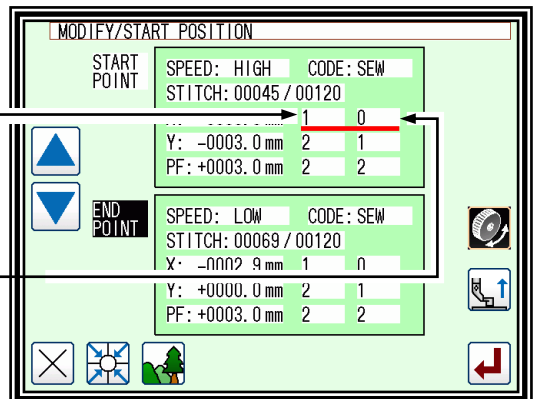

The above setting can be changed from the program mode "Digital tension".

## 27. PF holding power



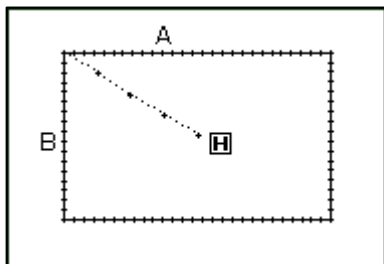

**Note** Program mode Presser foot ZVRB : Valid only for "ON"



[Example] Correct PF holding power value from point A to point B on the left sewing data.

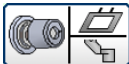

### Operation details

#### (1) Selecting PF holding power.

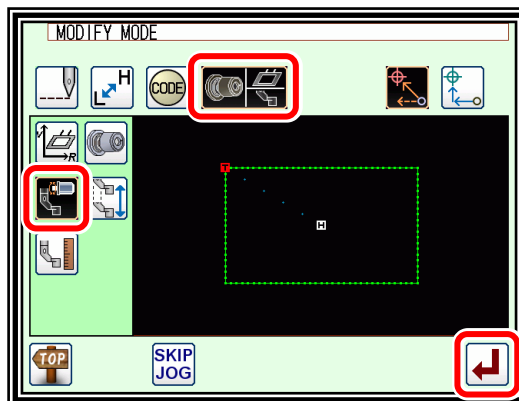
- ▶ Enter the modification mode. (Refer to page [11] - 2)
- ▶ Press  to switch the display and select .
- ▶ Press  to open the next screen.



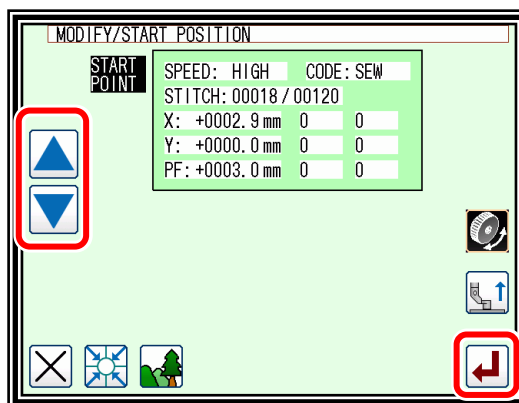

#### (2) Determining the range. (start point)

- ▶ Using Jog   determine the start point position. (A point)
- ▶ Press  after determining the position.



#### (3) Determining the range. (end point)

- ▶ Using Jog   determine the end point position. (B point)
- ▶ Press  after determining the position.

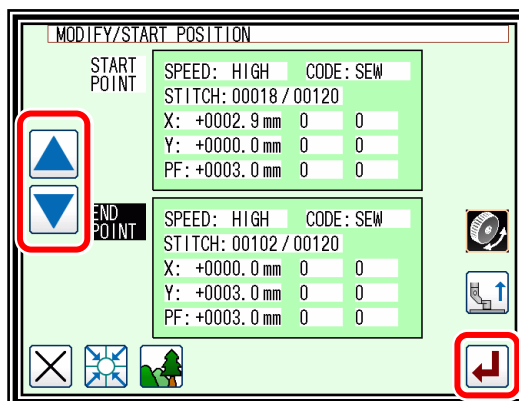

**Caution** When the end point is determined, the work holder will automatically return to the start point. Take care when the needle is lowered, etc.



(4) Setting the PF holding power and confirming execution.

► In case of set value   .

► After selecting from the setting value, press .

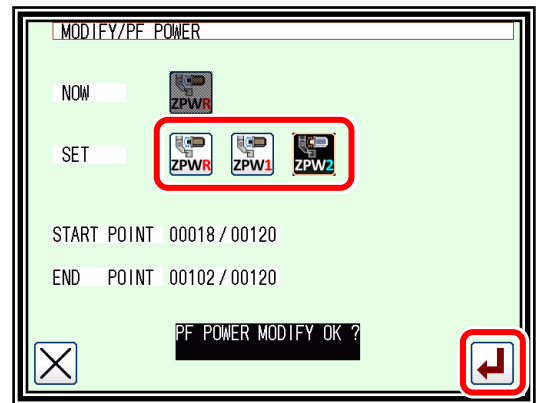

(5) Confirming the modifications.

► Quit the modification mode. Press  to change to the saving mode screen. It return to the standard screen after saving the data.

(When  is pressed, the modifications executed last will be undone.)

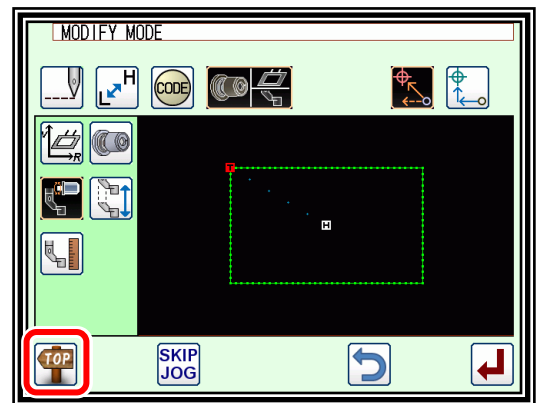



**Note** As a confirmation of the set value, press  again in Modify sewing quality items mode.

(It is  here)

The input screen of start point is displayed. (End point is the same)

The track is followed in JOG, the set value is displayed.

-  code default -> 0
-  code setting 1 -> 1
-  code setting 2 -> 2

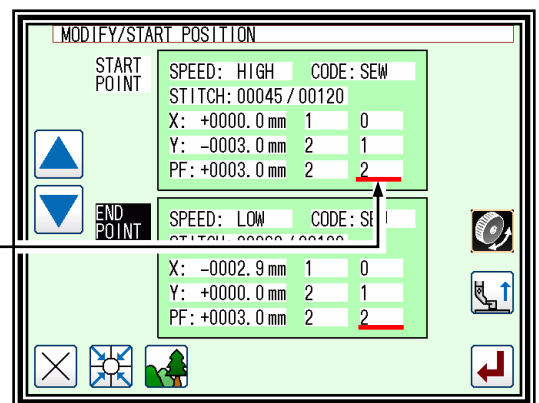

The above setting can be changed from the program mode "Presser foot".

## 28. PF stroke

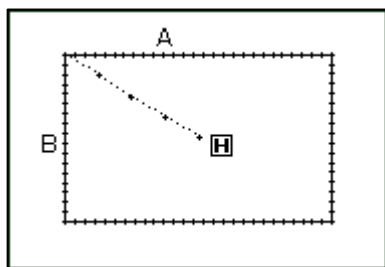



[Example] Correct PF stroke value from point A to point B on the left sewing data.

### Operation details

#### (1) Selecting PF stroke.

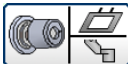
▶ Enter the modification mode. (Refer to page [11] - 2)

▶ Press  to switch the display and select .

▶ Press  to open the next screen.

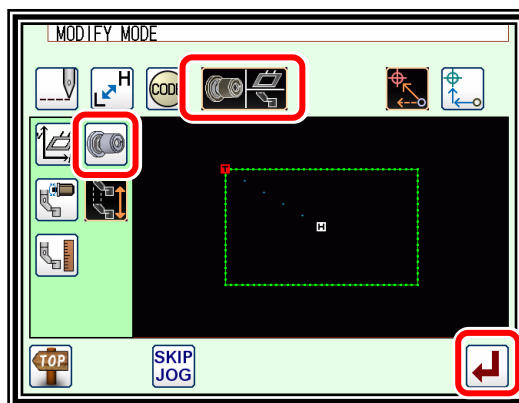

#### (2) Determining the range. (start point)

▶ Using Jog   determine the start point position. (A point)

▶ Press  after determining the position.

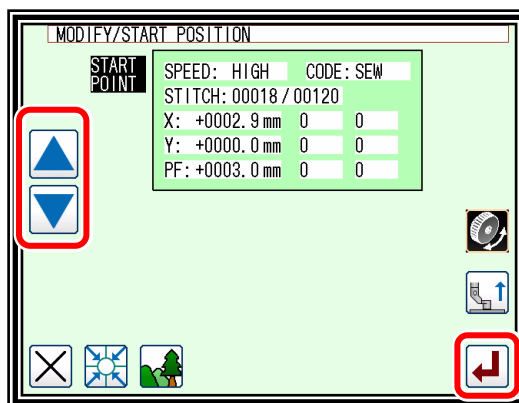

#### (3) Determining the range. (end point)

▶ Using Jog   determine the end point position. (B point)

▶ Press  after determining the position.

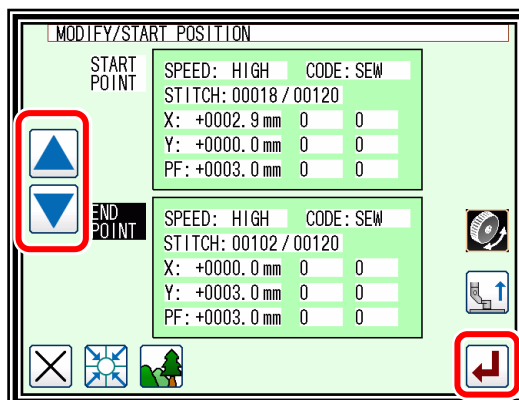

**Caution** When the end point is determined, the work holder will automatically return to the start point. Take care when the needle is lowered, etc.

(4) Setting the PF stroke and confirming execution.

► In case of set value   

► After selecting from the setting value, press 

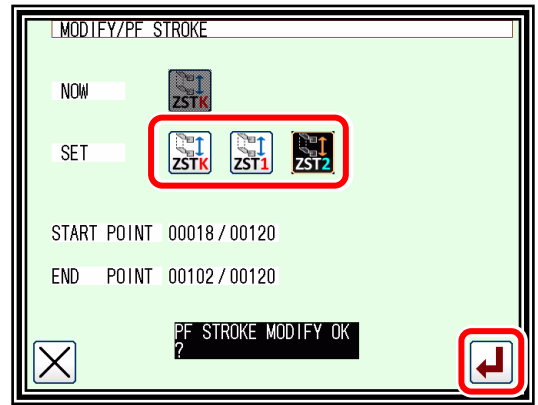

(5) Confirming the modifications.

► Quit the modification mode. Press  to change to the saving mode screen. It return to the standard screen after saving the data.

(When  is pressed, the modifications executed last will be undone.)





**Note** As a confirmation of the set value, press  again in Modify sewing quality items mode.

(It is  here)

The input screen of start point is displayed. (End point is the same)

The track is followed in JOG, the set value is displayed.

-  code default -> 0
-  code setting 1 -> 1
-  code setting 2 -> 2

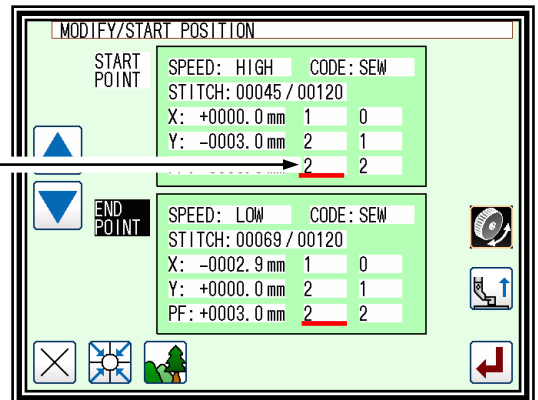

The above setting can be changed from the program mode "Presser foot".

## 29. PF height

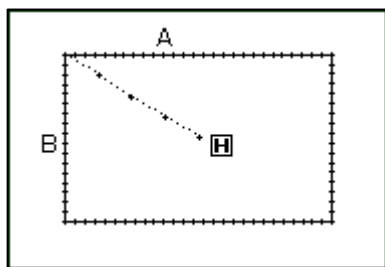



[Example] Correct to increase PF height 1.6mm from point A to point B on the left sewing data.  
(PF height original data is 3.0 mm.)

### Operation details

#### (1) Selecting PF height.

▶ Enter the modification mode. (Refer to page [11] - 2)

▶ Press  to switch the display and select .

▶ Press  to open the next screen.

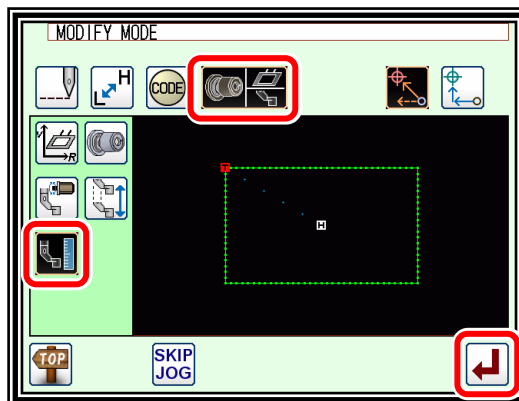

#### (2) Determining the range. (start point)

▶ Using Jog   determine the start point position. (A point)

▶ Press  after determining the position.

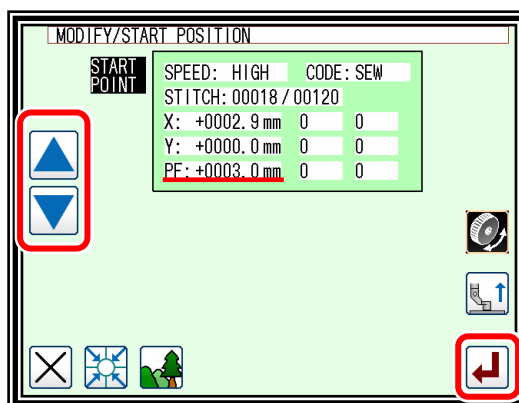

#### (3) Determining the range. (end point)

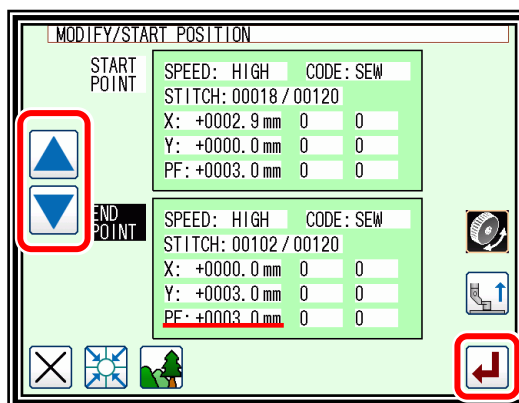

▶ Using Jog   determine the end point position. (B point)

▶ Press  after determining the position.



**Caution** When the end point is determined, the work holder will automatically return to the start point. Take care when the needle is lowered, etc.



(4) Setting the PF height.

▶ Press   to match the height you want to set. (Set it to + 1.6 mm here)

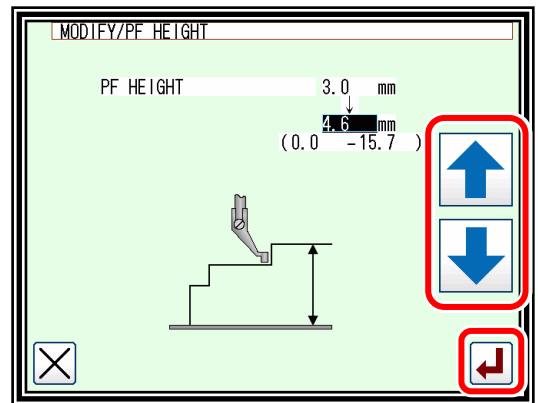
▶ Press  to confirm.



(5) Confirming the modifications.

▶ Quit the modification mode. Press  to change to the saving mode screen. It return to the standard screen after saving the data.  
(When  is pressed, the modifications executed last will be undone.)

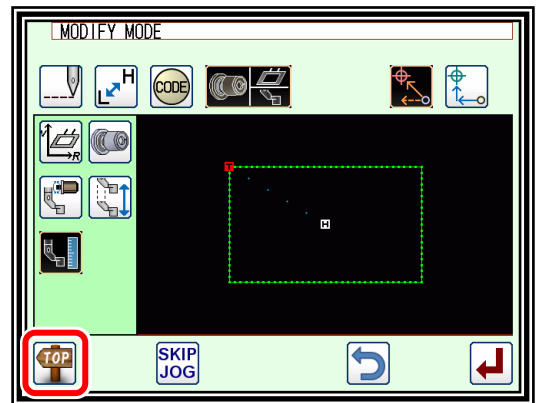

**Note** As a confirmation of the set value, press  again in the sewing quality item correction mode. (We will say  here)

The start point input screen is displayed. (End point is the same)

When you follow the trajectory with JOG on the standard screen, PF will operate at the set height.

# [12] Detecting material thickness (DFTH)



## Foolproof function

It is used when sewing multiple materials overlapping.

You can "foolproof" by entering the DFTH code to where you want to check the thickness.



I will explain the setting method. (It becomes the setting method from Modification mode)

(1) Operate from the standard screen.

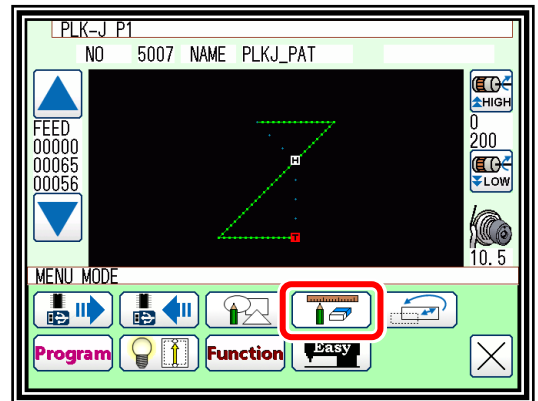
- ▶ Press  and  on the Standard screen to enter the modification mode.



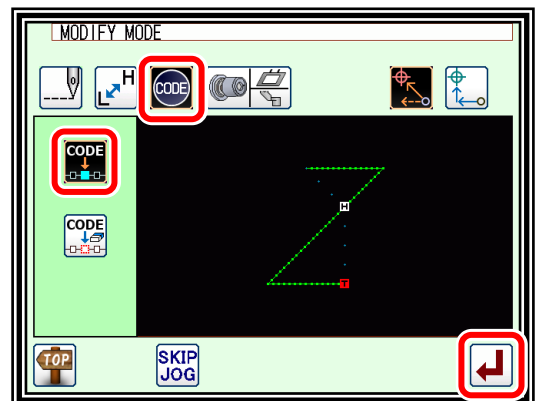

(2) Selecting code data addition.

- ▶ Enter the modification mode.
- ▶ Press Code Data Change , and then press Code Data Add .
- ▶ Press  to open the next screen.



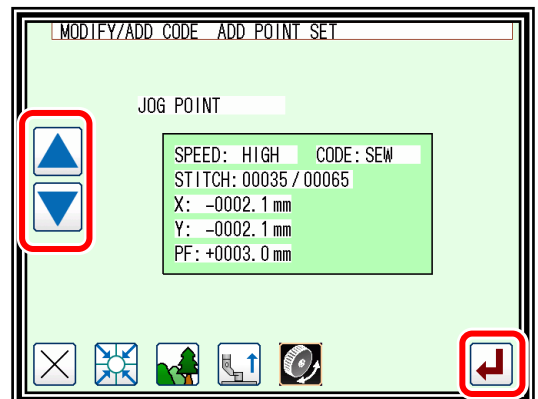

(3) Determining the code addition position.

- ▶ Using Jog   determine the position to add the code.
- ▶ Press  after determining the position.



(4) Setting the code to add.

- ▶ Press Detecting material thickness .
- ▶ Press .

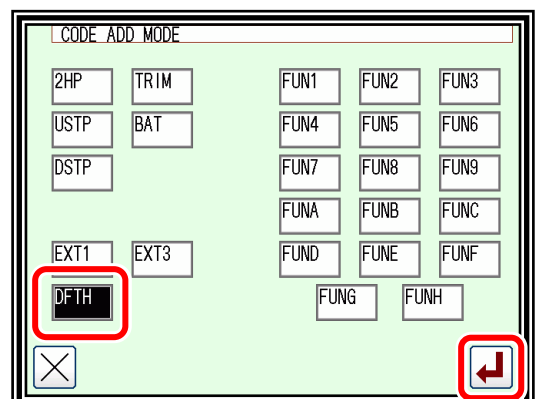

(5) Setting thickness to be detected

① Setting of reference point.(BASE = 0.00 mm)

Please do not put anything on Needle plate and Presser foot.

- ▶ Press Reset **R** and measure the distance (0mm) between Presser foot and Needle plate.

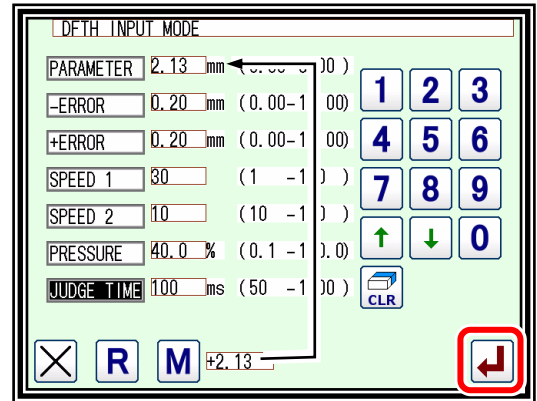

**Note** Be sure to reset when power is first applied. Deviation occurs. However, if resetting is done for the first time, it is unnecessary after that. (Even if you change the pattern)

② Set the sewing material to be detected.

- ▶ Press Measure **M** and measure the material thickness from the Needle plate.

③ Setting measurement value

- ▶ In **PARAMETER**, enter the value measured with Measure.
- ▶ In **-ERROR** and **+ERROR**, enter the error with respect to the value (thickness) entered in the parameter. (Approximately 10% of the parameter input value is a rough guide)

Please set the following depending on the usage.

- ▶ **SPEED 1** : Descending speed 1 of Presser foot at the time of measuring the thickness (from the beginning to the middle) / Rising speed after measurement
- ▶ **SPEED 2** : Descending speed 2 of Presser foot at the time of measuring the thickness (from the middle to the sewing material)
- ▶ **PRESSURE** : The power to hold the sewing material of Presser foot
- ▶ **JUDGE TIME** : Time to measure thickness

The setting is saved in program mode. Refer to page [20] - 23 "23.Traceability"

- ▶ When input is completed, press **Enter**.

(6) Confirming execution

- ▶ Press **Enter**.  
(The code data will be added.)

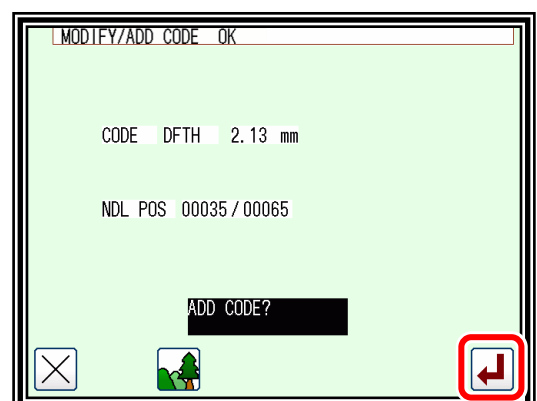

(7) Confirming the modifications

▶ "DFTH" code was entered.

▶ Quit the modification mode. Press  to change to the saving mode screen. It return to the standard screen after saving the data.

(When  is pressed, the modifications executed last will be undone.)

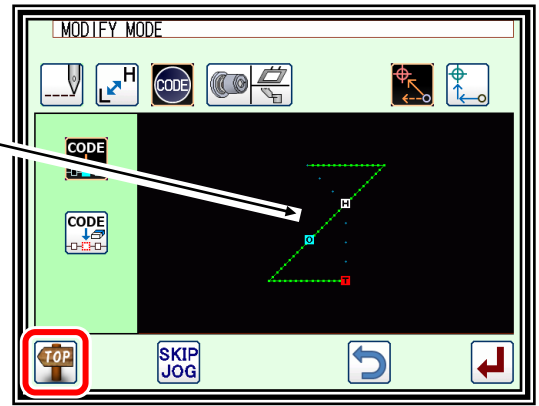

(8) Thickness detection display

▶ When measuring with the "DFTH" code at sewing and it was not good, a message is displayed.

▶ Press  to exit the message. Sewing starts from the continuation.

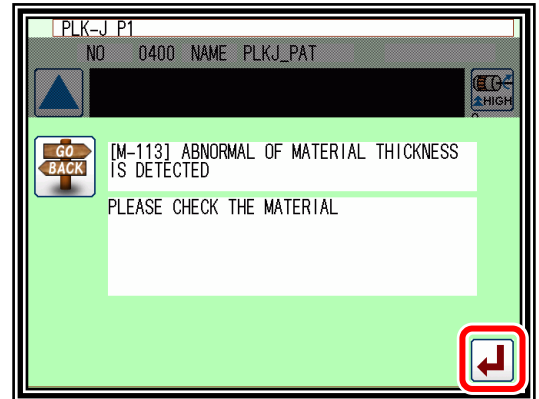

**Note** About reference point.(BASE = 0.00 mm)

you can set the reference point from the height adjustment screen of the middle presser.

▶ Press  to set the reference point of DFTH.

Even if the power is turned OFF / ON, the reference point remains at the set value.



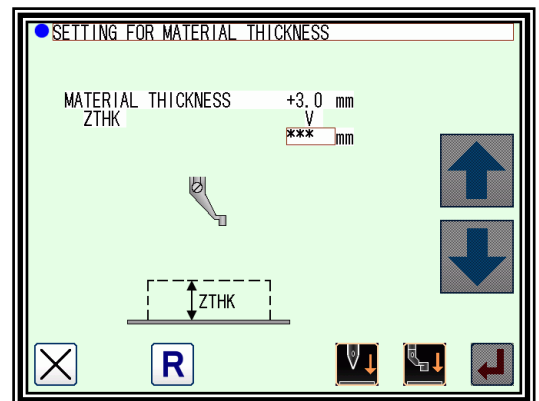















Refer to "[8] Control of medium press" for height adjustment of the middle presser







# [13] Data conversion mode

## 1. Main data conversion mode functions



Function	icon	Details	Details setting	
Back tacking (page [13]-3)		Existing back tacking can be modified, and new back tacking can be created.	 Start/end back tacking.  Overlap back tacking. (Valid only for a closed figure.)	
Zigzag stitching (page [13]-7)		Existing zigzag stitching can be modified, and new zigzag stitching can be created.	-	
Scaling (page [13]-9)		Scaling with a set stitch length or set No. of stitches can be carried out independently for the X axis and Y axis centering on the center point.	<Center position>  Jog Designation  Pattern Center.  Home position Center.	 No. of Stitches Fixed.  Fixed Stitch Length.
Symmetrical (page [13]-12)		Using the existing sewing data, X-axis, Y-axis, or XY axis symmetrical pattern can be created. Whether to keep or delete the existing stitching data can also be selected.	<Methods>  Symmetrical Origin Clear.  Keep Symmetrical Origin.	
Rotation (page [13]-13)		The pattern can be rotated centering on a random center point.	<Center Position>  Jog Designation.  Pattern Center.  Home position Center.	
Offset (page [13]-15)		The offset distance and direction for offset stitching data can be changed.	-	
Multiple (page [13]-17)		The multiple distance, multiple direction and number of multiple stitching times for multiple stitching data can be changed.	-	

## 2. Entering the conversion mode

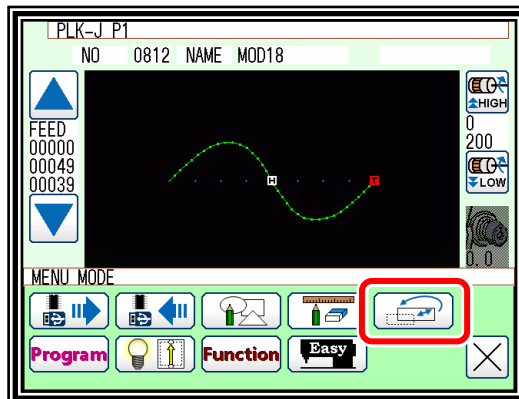
- Press  and  on the Standard screen to enter the conversion mode.



## 3. Quitting the conversion mode

- After converting the data, press  to quit the conversion mode.  
 (When  is pressed, the conversions executed last will be undone.)

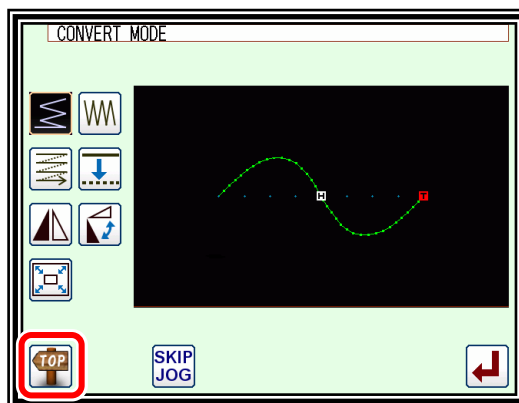

## 4. Confirming on the image screen (for the conversion mode)

(Refer to the section "5.Confirming on the image screen" for the modification mode for explanations common for the modification mode and conversion mode.) page [11] - 4

### ■ Scaling, rotation

- H** : Indicates the home position.  
 (Common for all Image screens.)  
**C** : Indicates the center position.

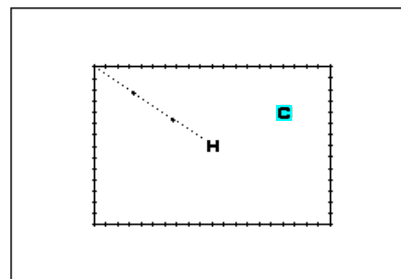

## 5. Back tacking (Start/end back tacking)



[Example] In the following type of stitching data, the start/end back tacking at the start of stitching (point A) and end of stitching (point B) is converted (added).

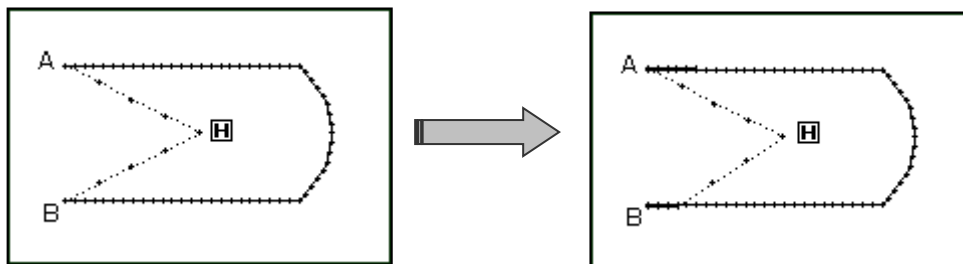

(The bold line indicates the back tacking)

### Operation details

#### (1) Selecting back tacking.

▶ Enter the conversion mode.

▶ Press Back tacking .

▶ Press .

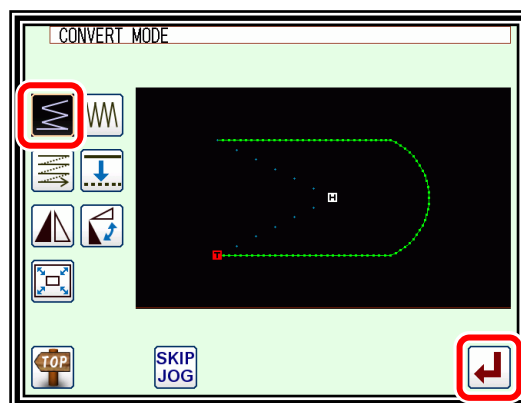

#### (2) Setting the block for converting back tacking.

▶ Using jogging, move to the block where back tacking is to be converted. (In this case, move to a point between point A and point B.)

▶ Press .

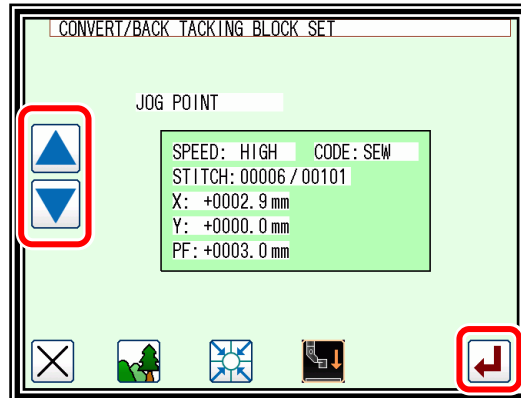

#### (3) Selecting start/end back tacking.

▶ Press start/end back tacking .

**Note** If the selected block is a "closed figure", the overlap back tacking icon will also appear. (Selection will be enabled.) This is not displayed in this example. (Selection is not possible.)

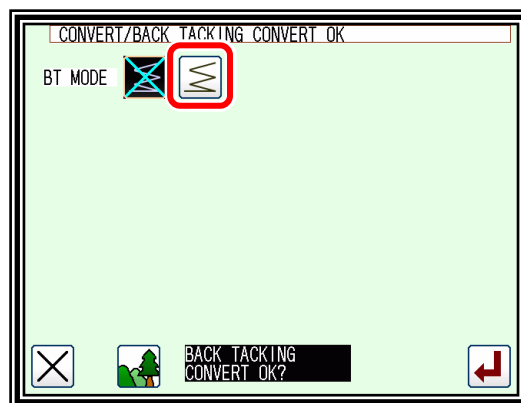

(4) Setting the back tacking details.

► The details are set on this screen.

(The details set here are,  (start/end back tacking)),

start mode  (N mode), five start stitches,

end mode  (M mode), three end stitches.)

► Press .

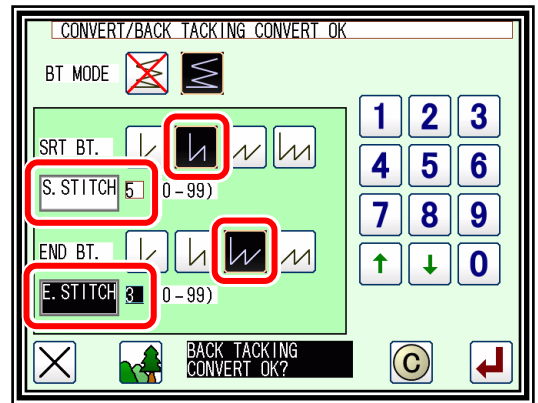

(5) Confirming execution of conversion.

► Quit the conversion mode.

Press  to change to the saving mode screen.

It return to the standard screen after saving the data.

(When  is pressed, the conversion executed last will be undone.)

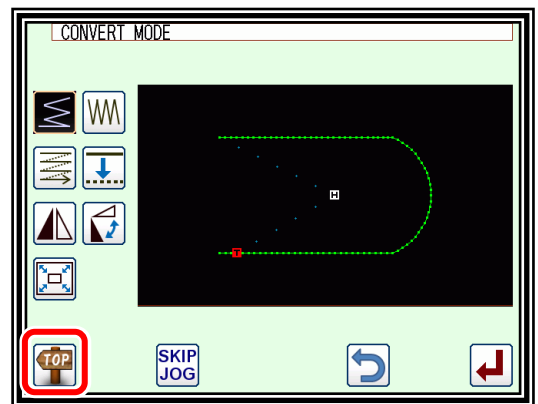

## 6. Back tacking (Overlap back tacking)



[Example] In the following type of stitching data, the overlap back tacking is converted (point A-B-C-D-A : Broken line)

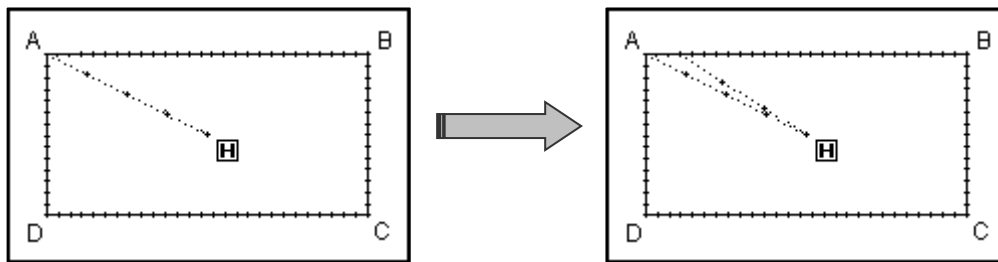

### Operation details

(1) Selecting back tacking.

▶ Enter the conversion mode.

▶ Press Back tacking .

▶ Press .

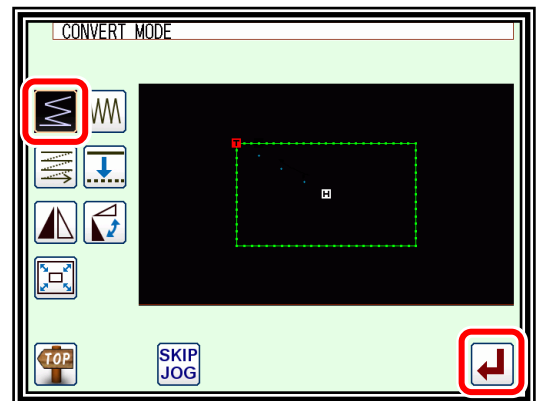

(2) Setting the block for converting back tacking.

▶ Using jogging, move to the block where back tacking is to be converted.

▶ Press .

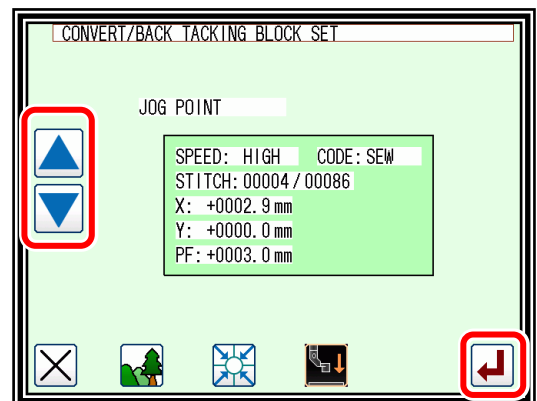

(3) Selecting overlap back tacking.

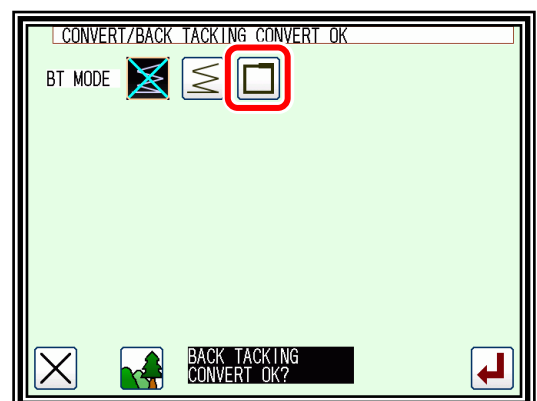

▶ Press overlap back tacking .

**Note** If the selected block is a "closed figure", the overlap back tacking icon will also appear. (Selection will be enabled.) This is displayed in this example. (Selection is possible.)



(4) Setting the back tacking details.

► The details are set on this screen.

(The details set here are,  (overlap back tacking), overlap mode , three overlap stitches.)

► Press .

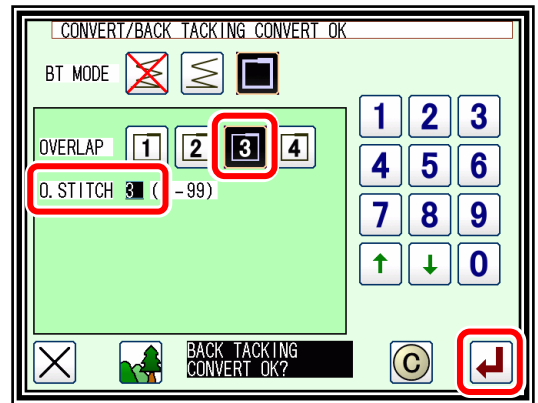

(5) Confirming execution of conversion.

► Quit the conversion mode.

Press  to change to the saving mode screen.

It return to the standard screen after saving the data.

(When  is pressed, the conversion executed last will be undone.)

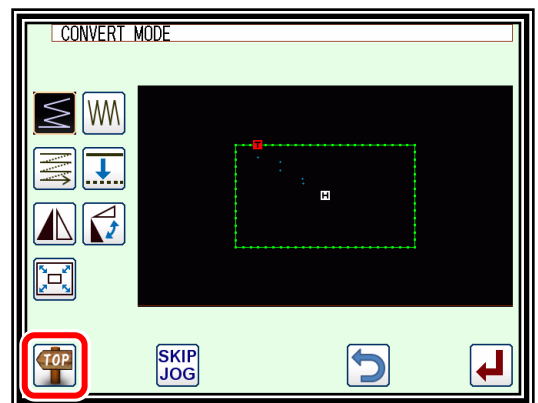

## 7. Zigzag stitching

[Example] In the following type of stitching data, the arc section between point B and point C is converted (added) to zigzag stitching. (Point A to point B: linear, point B to point C: arc, point C to point D: linear)

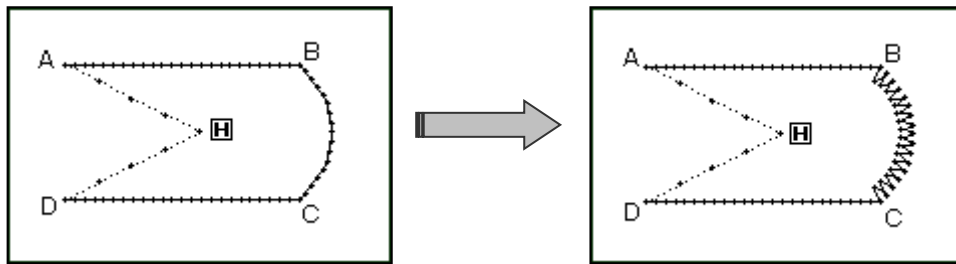

### Operation details

#### (1) Selecting zigzag stitching.

▶ Enter the conversion mode.

▶ Press zigzag .

▶ Press .

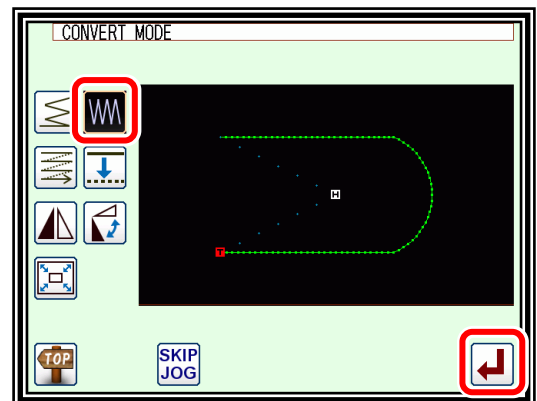

#### (2) Setting the block for converting zigzag.

▶ Using jogging, move to the block to be converted to zigzag stitching. (In this case, move to the arc section (point between point B and point C).)

▶ Press .

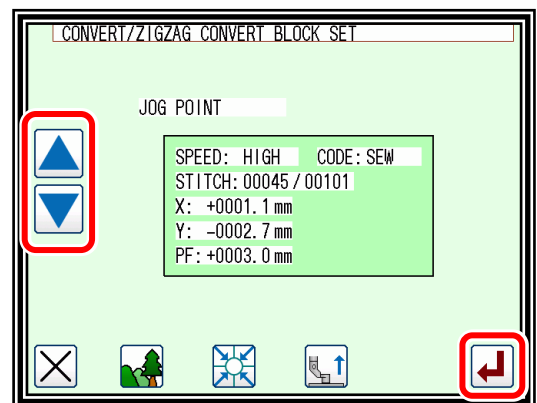

**Note** The block range can be confirmed easily when the Image screen is opened from the (2) screen.

▶ Press  from the (2) screen.

▶ Press  to return.

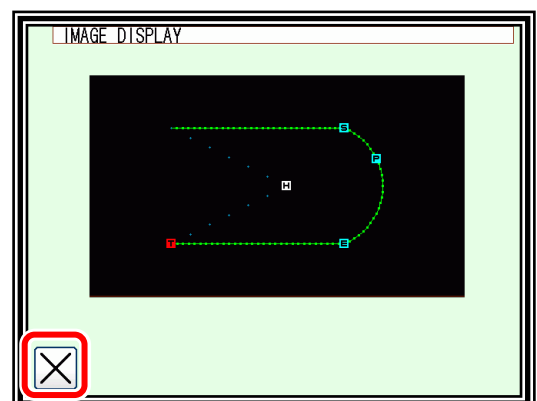



(3) Selecting zigzag.

▶ Press zigzag .





(4) Setting the zigzag details.

▶ The details are set on this screen.  
(Press , set the deflection width to 4.0, and feed amount to 3.0, The creation direction is )  
(Refer to page [7] - 36 "12.Zigzag stitching (with overlap back tacking)" for details on the deflection width, feed amount and creation direction.)

▶ Press .



(5) Confirming the converted data.

▶ Quit the conversion mode.  
Press  to change to the saving mode screen.  
It return to the standard screen after saving the data.  
(When  is pressed, the conversion executed last will be undone.)

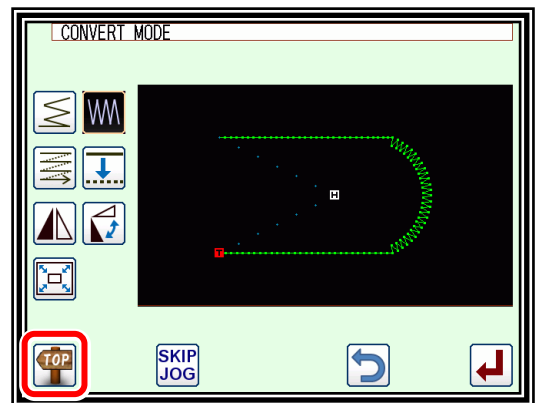



## 8. Scaling



[Example] The data will be reduced (X: 50%, 75%) with a fixed stitch length centering on the A' point in the following type of stitching data.

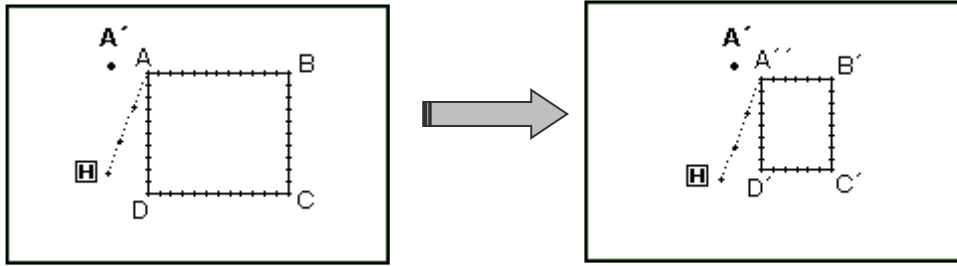

### Operation details

#### (1) Selecting scaling.

▶ Enter the conversion mode.

▶ Press scaling .

▶ Press .

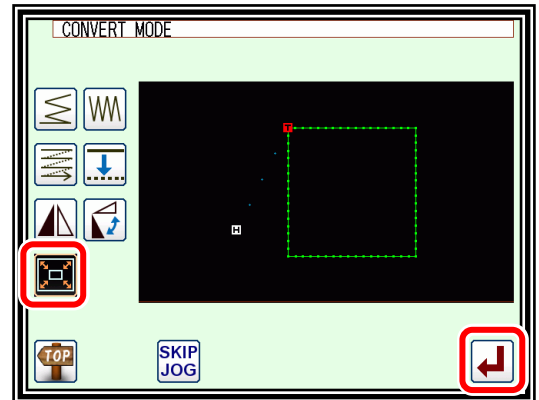

#### (2) Setting the scaling method, etc.

▶ Method

: No. of Stitches Fixed.

: Fixed Stitch Length.

(Press Fixed Stitch Length for this example.)

▶ Set the X, Y enlargement rate (reduction rate) with the numeric keypad or up/down arrow icons.

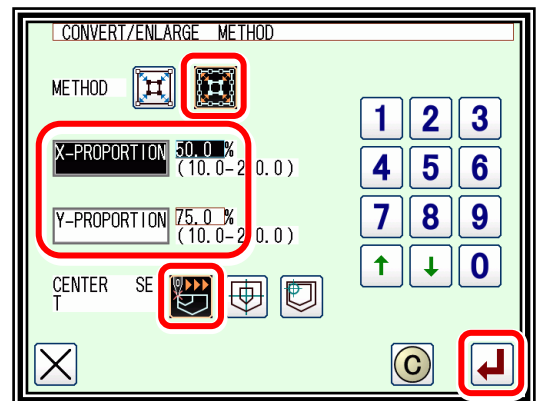

▶ Center designation.

: Jog center designation, : Pattern center, : Home position center

(Press Jog Center Designation for this example.)

▶ Press .

#### (3) Setting the center position.

▶ In the jog mode, move to the needle near the desired enlargement/contraction center. (In this case, move to point A that is near point A'.)

▶ Press .

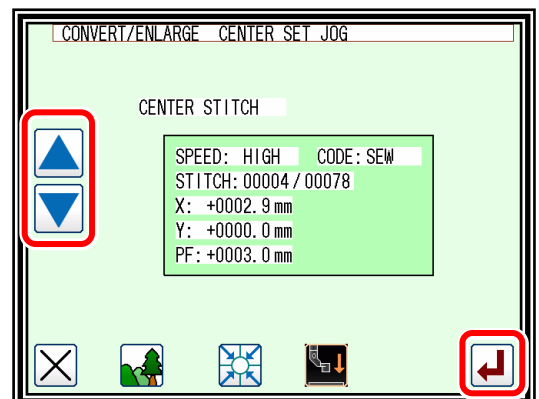

### Note

The center point can be designated without using the jog icons. In this case, press only





(4) Setting the center position details.

▶ If the center point is not to be set on the stitching data, use the arrow icons and move to the position to be used as the center. (A' point)

▶ After moving to the desired center position,

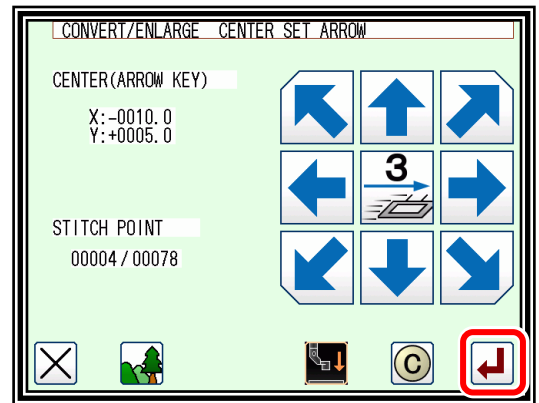
press .



**Note** If the desired center position is on the pattern data, do not move using the arrow, but just press .

(5) Confirming execution of conversion.

▶ Press .

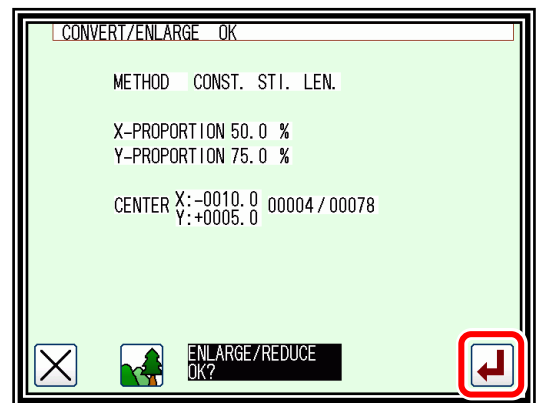

(6) Confirming the converted data.

▶ Quit the conversion mode.

Press  to change to the saving mode screen.

It return to the standard screen after saving the data.

(When  is pressed, the conversion executed last will be undone.)

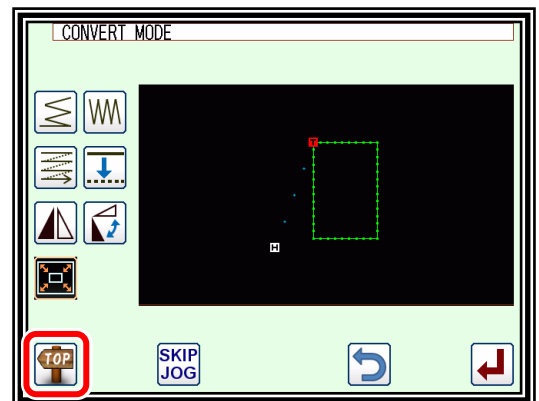

**Note 1** Circle scaling.

A circle will be created even if the X, Y enlargement ratio/contraction ratio are set to different values.

**Note 2** Expanded/reduces for zigzag sewing, multiple sewing.

Sewing in zigzag, multiple, and offset an under mentioned set item is not influenced by the expansion/the reduction.

(The function as the offset is lost by the expansion/the reduction about the offset.)

- "Amount of stitch length" and "Width of shake" of zigzag sewing
- "Distance" of multiple sewing

(Do not use expansion/reduction but respectively to change these zigzag sewing, multiple sewing, offset sewing in the conversion mode if modify to do.)

[Example] As shown in the figure below, if the data of multiple sewing [A] with a distance of 3 mm is enlarged with the X enlargement ratio set to 200%, it will be enlarged with the distance of 3 mm as shown in [B].

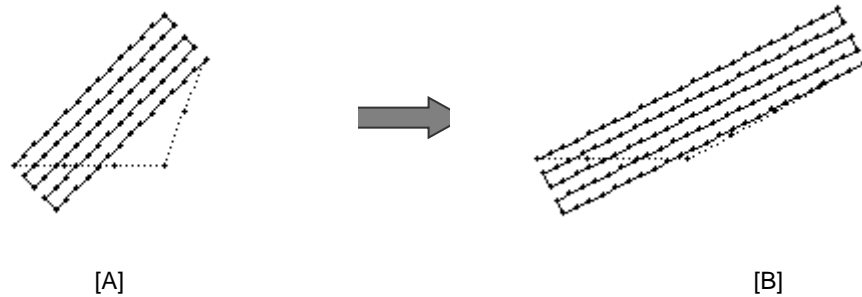

**Note 3** "Fixed stitch number/stitch length fixed" setting for expanded/reduces for zigzag sewing  
"Stitch number fixed/stitch length fixed" setting of the expansion/the reduction is not influenced by zigzag sewing. (Please refer to page [13] - 7 or page [11] - 32.)

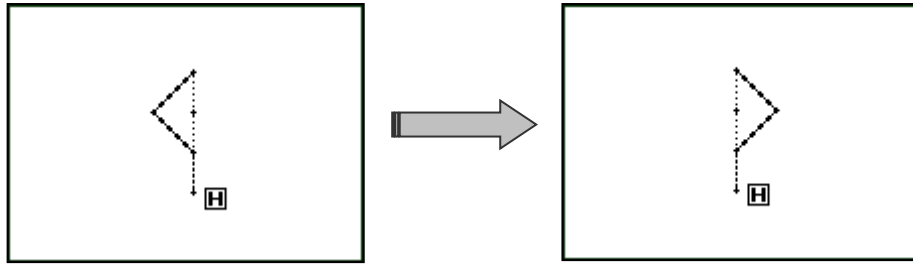

## 9. Symmetrical

[Example] The left state of the following type of stitching data will be converted into a right state.





### Operation details

#### (1) Selecting symmetrical.

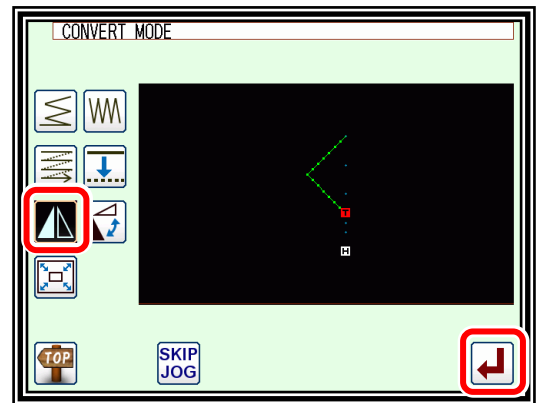
- ▶ Enter the conversion mode.
- ▶ Press Symmetrical .
- ▶ Press .





#### (2) Setting symmetrical method, etc., and executing.

- ▶ Clearing symmetrical origin data.
  -  :Delete Symmetrical Origin Data.
  -  :Keep Symmetrical Origin Data.
 (Press "Delete" for this example.)

**Note** When "Keep symmetrical original data" is selected, "material stel level" setting is not reflected to symmetrical data.



#### ▶ Method

-  : X Symmetrical Data Creation,  : Y Symmetrical Data Creation,
-  : XY Symmetrical Data Creation. (Press "X Symmetrical Data Creation" for this example.)

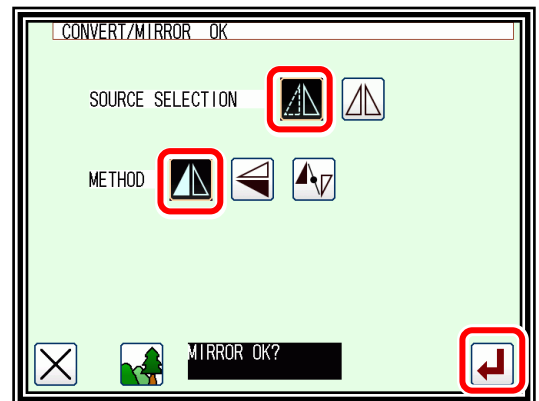
- ▶ Press .



#### (3) Confirming execution of conversion.

- ▶ Quit the conversion mode.
  - Press  to change to the saving mode screen.
  - It return to the standard screen after saving the data.
  - (When  is pressed, the conversion executed last will be undone.)

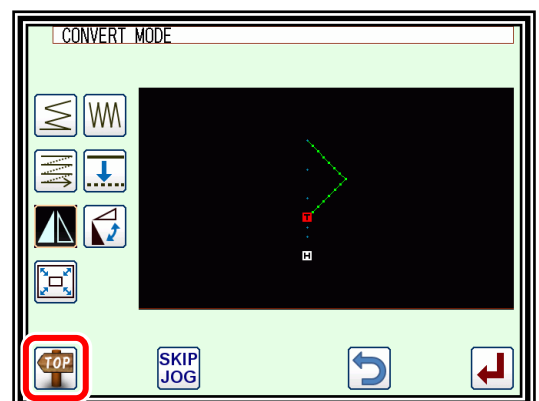

**Note** When symmetrically converting a pattern with 2 HP and DFTH code, the code disappears. Please add code from fix mode.

# 10. Rotation



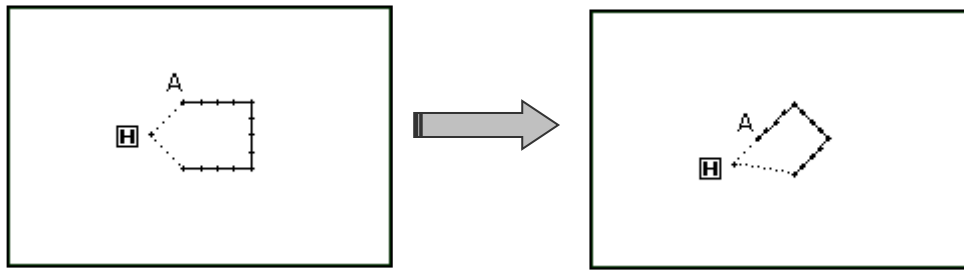

[Example] The pattern will be rotated by 45° centering on the A point in the following type of stitching data.





## Operation details

### (1) Selecting rotation.

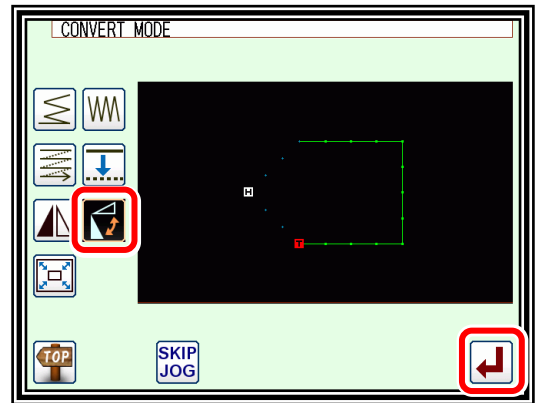



- ▶ Enter the conversion mode.
- ▶ Press Rotation .
- ▶ Press .

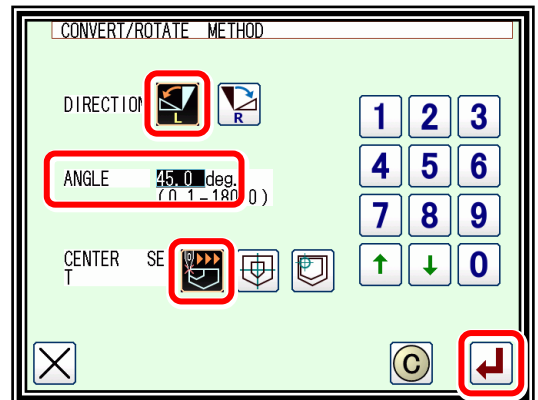

### (2) Setting the rotation method, etc.

- ▶ Direction
  -  :Left Rotation
  -  :Right Rotation
 (Press "Left Rotation" for this example.)



- ▶ Angle  
Input the angle from the numeric keypad.  
(Input 45° for this example.)
- ▶ Center Designation
  -  :Jog center designation,  : Pattern center,
  -  : Home position center (Press "Jog Center Designation" for this example.)
- ▶ Press .

### (3) Setting the center position.

- ▶ In the jog mode, move to the needle near the desired center.
- ▶ Press .

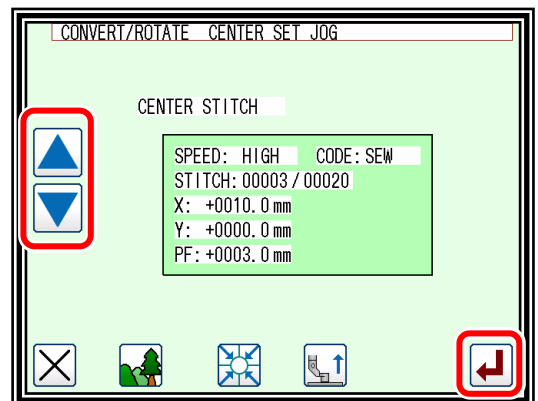



**Note** The center point can be used without using the jog icons. In this case, press only .

(4) Setting the center position details.

► If the center point is not to be set on the stitching data, use the arrow icons and move to the position to be used as the center.

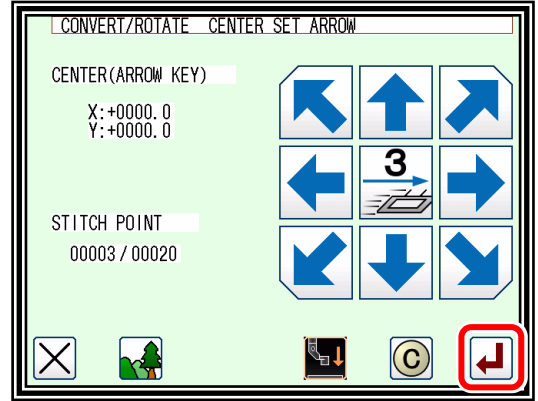
► After setting the center, press .



**Note** If the desired center position is on the pattern data, do not move using the arrow, but just press .

(5) Confirming execution of conversion.

► Press .

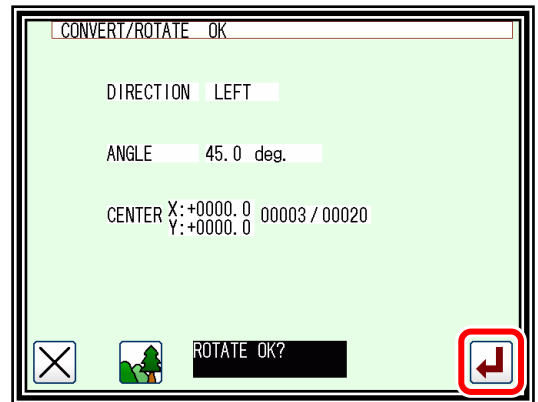

(6) Confirming the converted data.

► Quit the conversion mode.

Press  to change to the saving mode screen.

It return to the standard screen after saving the data.

(When  is pressed, the conversion executed last will be undone.)

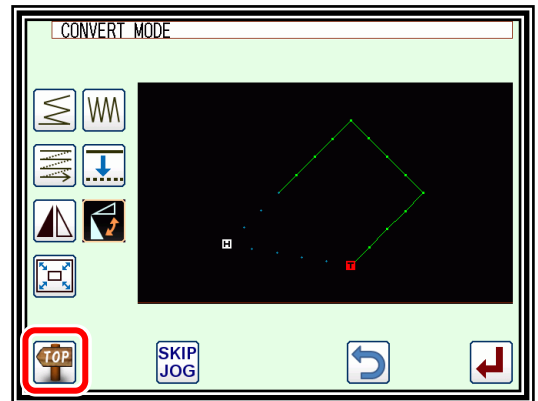

# 11. Offset



[Example] The offset distance for the offset stitches A-B and C-D in the following type of stitching data will be changed and converted into A'-B' and C'-D'. (The offset amount will be A-B: 5mm, C-D: 7mm, A'-B': 7mm, and C'-D': 9mm respectively.)

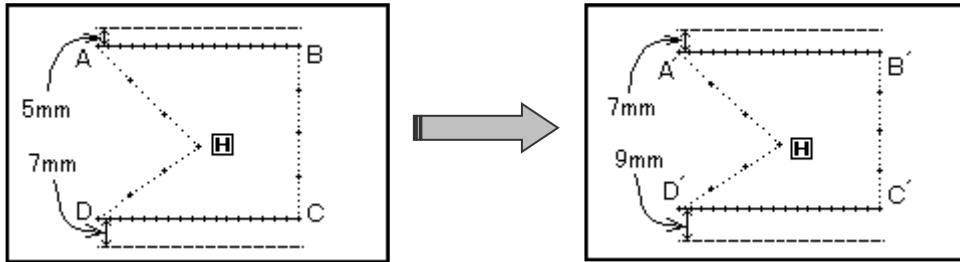

## Operation details

### (1) Selecting offset.

▶ Enter the conversion mode.

▶ Press Offset

▶ Press

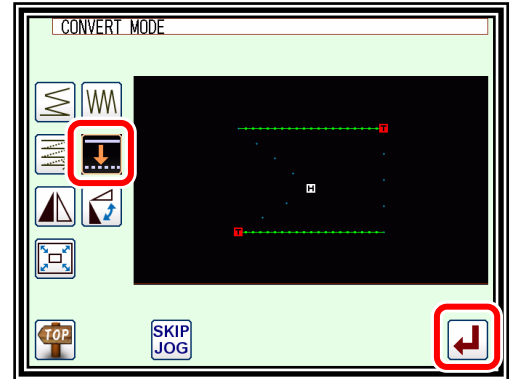

### (2) Selecting and confirming the changed offset.

▶ Press or to select the offset to be changed.  
(The offset numbers No. 1, 2, 3... are assigned in the created order.)  
(In this case, select the first offset data.)

▶ Press after select the data.

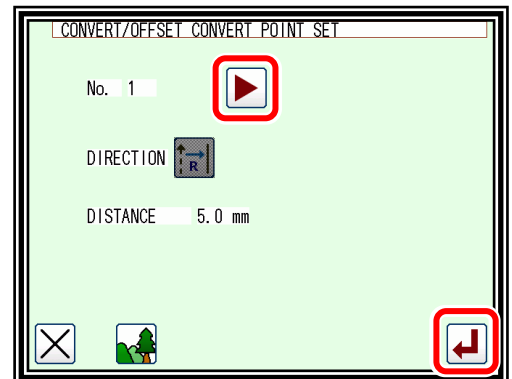

### (3) Confirming the offset No. (Image screen)

▶ Press on the screen displayed in step 2.

▶ The offset No. will be expressed with and .

▶ Press to return to the original screen.

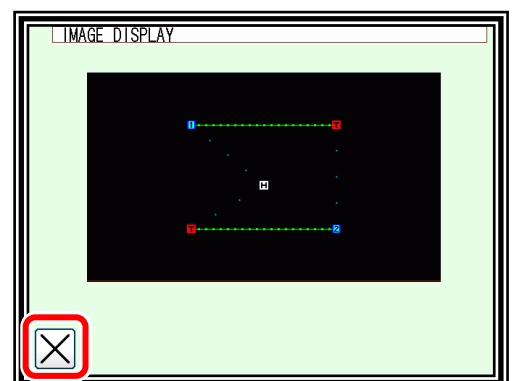

### (4) Setting and executing the conversion method.

▶ Select the direction. (In this case, select "left".)

Left direction

Right direction

▶ Input the distance. (Input 7mm for this example.)

▶ Press .

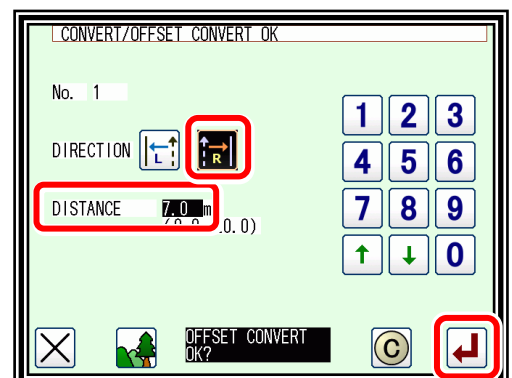

(5) Completing the first conversion.

▶ Press  to start the second conversion.

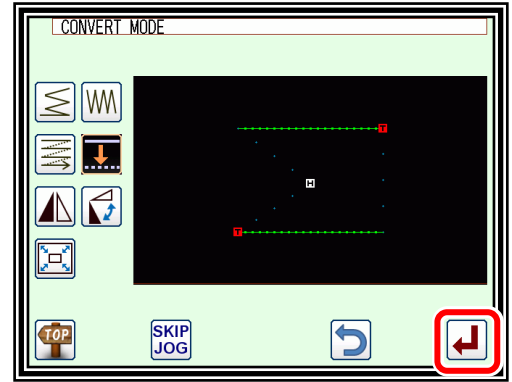

(6) Selecting and confirming the next offset.

▶ Using the arrow icons ( ) , select the offset to be changed.

▶ Press  after setting the data.

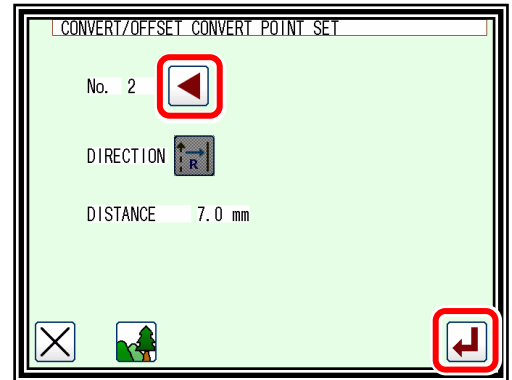

(7) Setting and executing the conversion method.

▶ Select the direction. (In this case, select "Right".)

 Left direction

 Right direction

▶ Input the distance. (Input 9mm for this example.)

▶ Press .

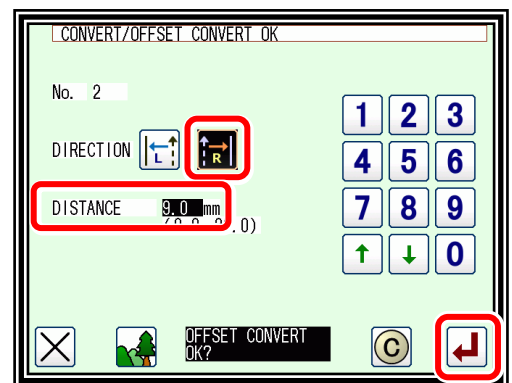

(8) Completing the second conversion.

▶ Quit the conversion mode.

Press  to change to the saving mode screen.

It return to the standard screen after saving the data.(When  is pressed, the conversion executed last will be undone.)

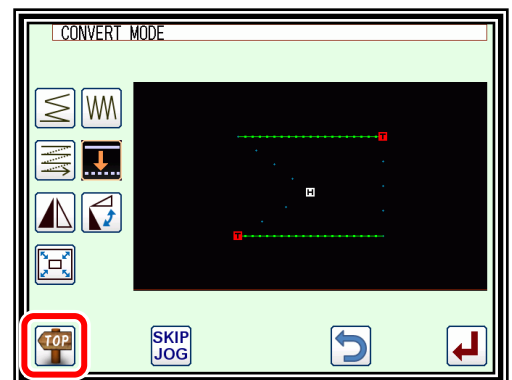



## 12. Multiple



[Example] ABCD designated two times for multiple stitching (feed data specifications) in the following type of stitching data, will be converted to the ABC'D'EF designated three times for reverse multiple stitching (feed data specifications).

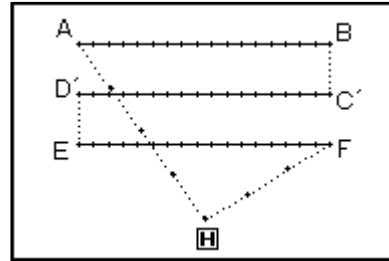
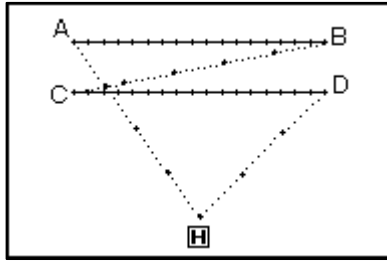

### Operation details

(1) Selecting multiple stitching.



▶ Enter the conversion mode.

▶ Press Multiple Stitching .

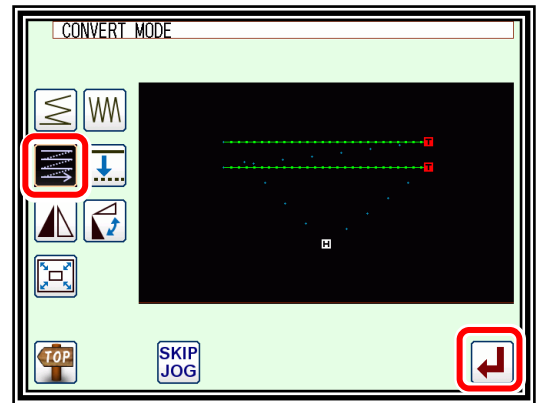
▶ Press .



(2) Selecting and confirming the multiple stitching to be changed.

▶ If there are multiple settings, press the arrow icons ( ) (which appear when there are multiple settings), and change the setting.

▶ Press  after changing the setting.



(3) Confirming on the image screen.

▶ press  on the screen displayed in step 2.



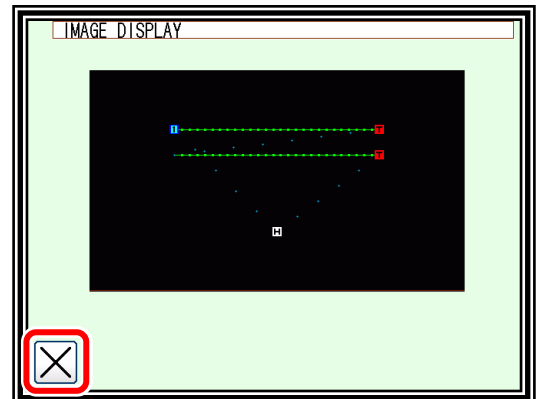

▶ Confirm the multiple No., etc.

▶ Press  to return to the original screen.





(4) Setting the conversion method.

- ▶ Select and input the multiple stitching method, direction, distance and number of times.

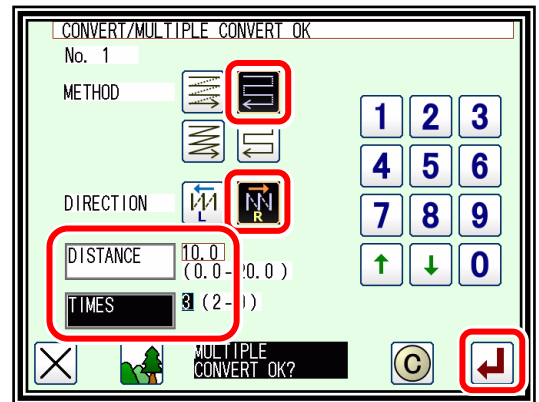
-  Multiple (Feed data)
  -  Reverse Multiple (Feed data)
  -  Multiple (Stitching specifications)
  -  Reverse Multiple (Stitching specifications)
- (In this case, select the "Multiple (Stitching specifications)").





- ▶ Select the direction. (In this case, select "right".)

-  Left direction
-  Right direction

- ▶ Input the distance value. (In this case, input "10 mm".)
- ▶ Input the number of times. (In this case, input "3 times".)
- ▶ Press .

(5) Confirming execution of conversion.



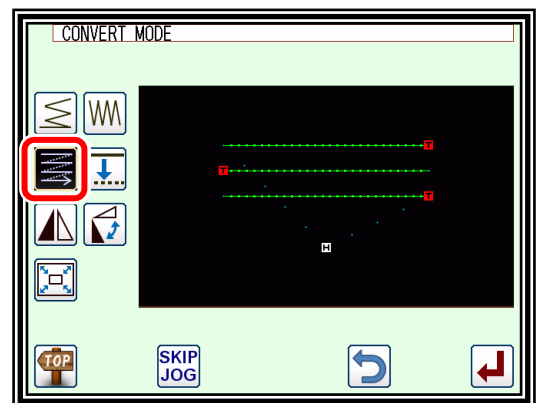





- ▶ Quit the conversion mode.  
Press  to change to the saving mode screen.  
It return to the standard screen after saving the data.  
(When  is pressed, the conversion executed last will be undone.)

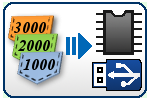
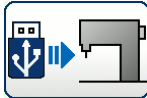
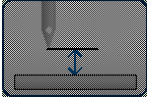

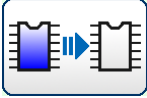
# [14] Function mode

## 1. Outline

### ■ List of function modes

	Copy mode		Set file read
	Do not use		Set file write
	Format mode		Combination mode
	Panel related settings		Advanced functions
	Version confirmation		Step view
			Step delay

### ■ Entering the function mode

► Press  and **Function** on the Standard screen, and open the Function Mode screen.

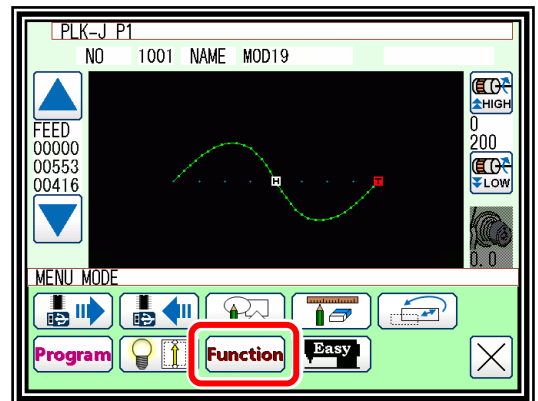

### ■ Function Mode screen

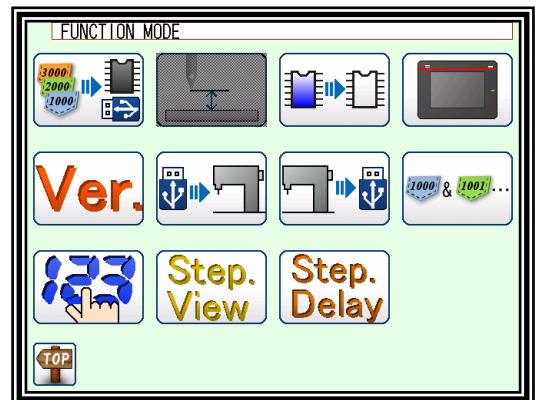

## 2. Explanation of each function mode

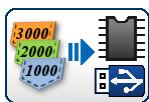

### Copy mode

The sewing data is copied "from the internal memory to an USB memory" or "from an USB memory to the internal memory".

[Note] Please erase all data of the USB memory beforehand when copying sewing data from an internal memory.

[Note] Sewing data will be copied in the overwriting mode. For this reason, if the sewing data having the same data number is in the internal memory, the new sewing data will be overwritten on the old sewing data.

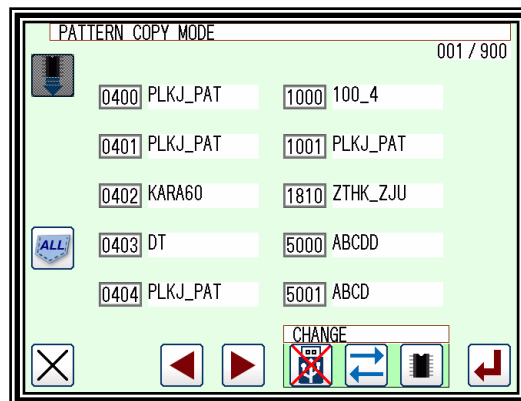

Select the copying direction in the same way as the data reading/writing operation. (Check the picture of the icon shown at the upper left section of the screen.)





From internal memory to USB memory



From USB memory to internal memory

Select the data you would like to copy by pressing the corresponding numeric icon (maximum 30).

After that, press  to copy the data. (To select all the data, press .)

**Note** Amount of data which can be stored in the USB memory will be limited by capacity of the USB memory and also format type specification of the USB memory. Therefore, there is some cases, where data cannot be saved even if there is enough empty space. Please check the manual of the USB memory.

Copy from internal memory to USB memory.

▶ The upper left corner of the screen is displayed as





(Press  to become internal memory.)

▶ Select the  you want to copy.

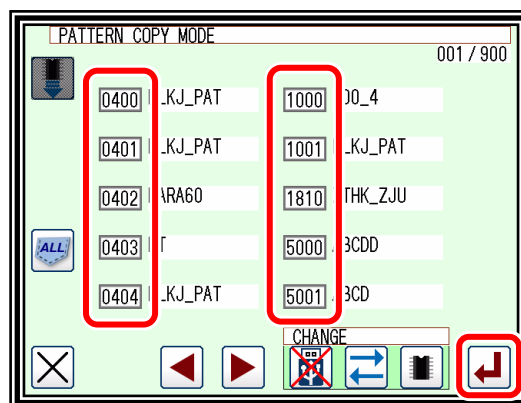
▶ When you press , copy is executed.



▶ Copying from USB memory to internal memory is the same.

(To display the internal memory, pressing  or  switches it)

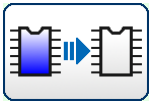

Format mode



Formats the internal memory. All the pattern data are cleared. If the message like [ Internal memory is defect ] is appeared, please press this button.

Please back up data always so as not to lose data.

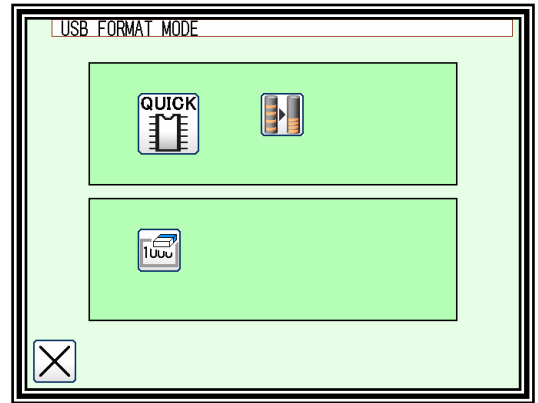

Optimizes the internal memory. The pattern data are not erased. When preserved sewing pattern data increased and an empty space of an internal memory decreases, empty space might be able to be increased by executing optimization. (It is recommended to backup and perform optimization sometimes)



Clear the registration of the shortcut icon displayed on the standard screen.



Panel related settings

Various settings related to the panel can be made.

#### [LCD Backlight Auto OFF]

The panel will automatically turn OFF if the panel is not touched within the set time. Setting range: 1 to 9 minutes Canceling method: Touch the panel which is turned OFF.

(The automatic OFF function will remain "Valid" until the LCD backlight automatic OFF function is set to "Invalid".)

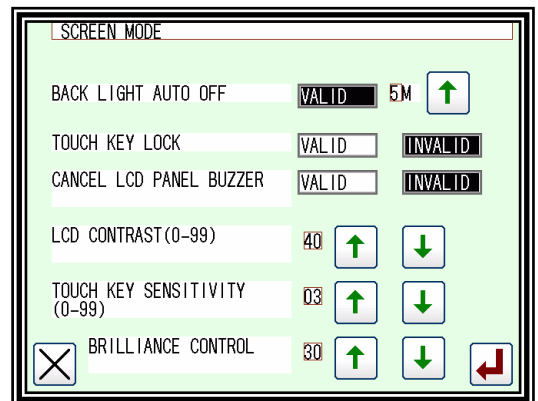

#### [Touch Key Lock]

When this function is set to "Valid", the icons will be ignored even if pressed, and the incorrect operation prevention mode will be entered.

Canceling method: To cancel the incorrect operation prevention mode, press any place on the panel for five or more seconds. A beep will sound to indicate that the function has been canceled. (The touch key lock will be completely set to "Invalid" with this cancellation.)

Initial value: "Invalid"

#### [Cancel LCD panel buzzer]

When it is set to enable, sounds will not ring.

#### [LCD Contrast]

Set the panel contrast.

Setting range: 0 to 99 (The screen will dim as the value is increased.) Initial value : "forty"

## [Key Noise Processing]

The noise will increase as this value is increased. The icon response speed will also drop.  
(The opposite will occur when the value is decreased.)  
Setting range: 0 to 99 Initial value : "three"

## [Brilliance control]

Sets brightness of the operation panel.  
Setting range: 0 to 50 Initial value : "thirty"

## Version confirmation

The version of each model's current system can be confirmed.

(The version shown on the right is an example.)

You can check the version by pressing the  button while inserting the USB containing the installation file.

Refer to page [18] – 5.

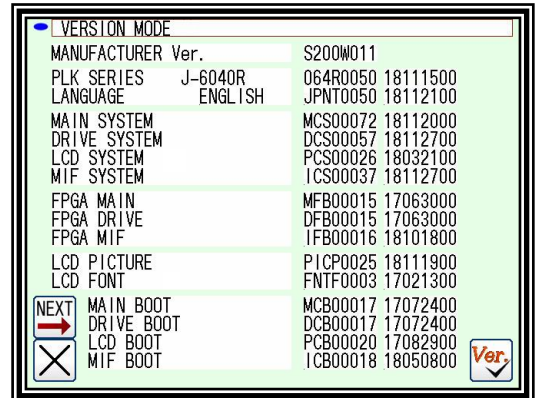

VERSION MODE	
MANUFACTURER Ver.	S200W011
PLK SERIES	J-6040R 0G4R0050 18111500
LANGUAGE	ENGLISH JPNT0050 18112100
MAIN SYSTEM	MCS00072 18112000
DRIVE SYSTEM	DCS00057 18112700
LCD SYSTEM	PCS00026 18032100
MIF SYSTEM	ICS00037 18112700
FPGA MAIN	MFB00015 17063000
FPGA DRIVE	DFB00015 17063000
FPGA MIF	IFB00016 18101800
LCD PICTURE	PICP0025 18111900
LCD FONT	FNTF0003 17021300
MAIN BOOT	MCB00017 17072400
DRIVE BOOT	DCB00017 17072400
LCD BOOT	PCB00020 17082900
MIF BOOT	ICB00018 18050800

## Network settings

Press  to turn on the password screen.

After entering the password, you can go to the network setting screen and set the IP address, Subnet mask, Default gateway. For use / setting method, please consult your dealer.

## Setting file read

Setting files or step files written (backed up) on an USB memory are read out.





**Note** The data is read in the overwrite mode, so the setting file originally in the internal memory will be erased.

[\*.JTL] ---The setting data

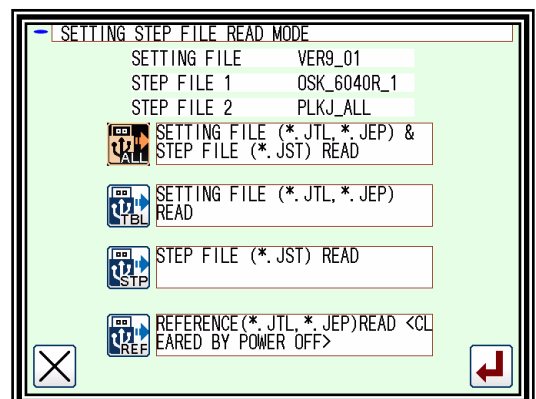
[\*.JEP] ---The setting data(Currently used table)

[\*.JST] ---The step file



SETTING STEP FILE READ MODE	
SETTING FILE	VER9_01
STEP FILE 1	OSK_6040R_1
STEP FILE 2	PLKJ_ALL
 SETTING FILE (*.JTL, *.JEP) & STEP FILE (*.JST) READ	
 SETTING FILE (*.JTL, *.JEP) READ	
 STEP FILE (*.JST) READ	
 REFERENCE(*.JTL, *.JEP)READ <CL EARED BY POWER OFF>	

For detail operation, refer page [16] - 5.

Reference setting --- You can easily compare the setting data on the USB with the current value. USB setting data (reference value) can also be changed to the current value. When the power is turned off, the reference value is not displayed, so reloading is necessary. Refer to page [15] - 5 and [16] - 3.

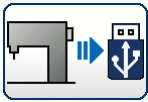

## Setting file write

The system setting files and step files are written (backed up) on an USB memory.

If various files are stored, be careful not to overwrite new data on a file.

For detail operation, refer page [16] - 4.

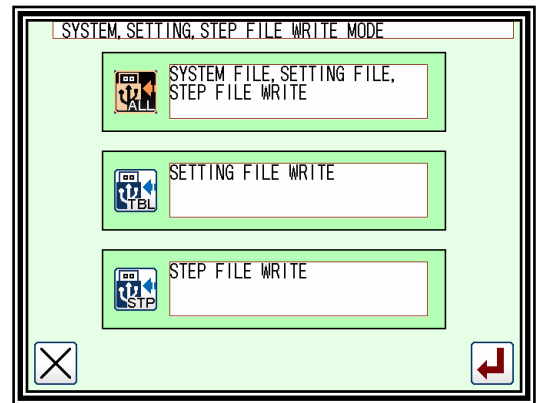

## Advanced functions

"Advanced functions" can be set by inputting a password.

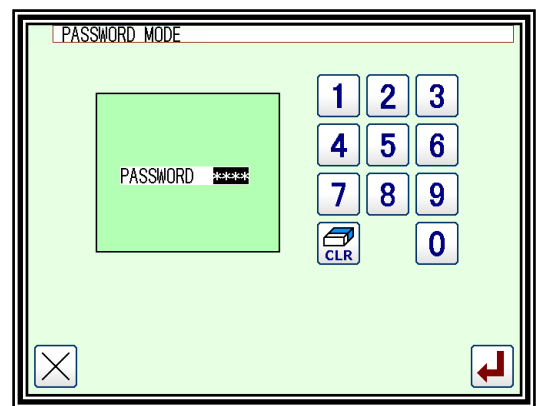

## Combination mode

It is possible to combine and connect some stitching data.

**Combination:** It is possible to combine some stitching data. It is a function to bring some stitching data in one group to sew with the specification order. After sewing each data, the following data is sequentially sewn again by the start signal input.

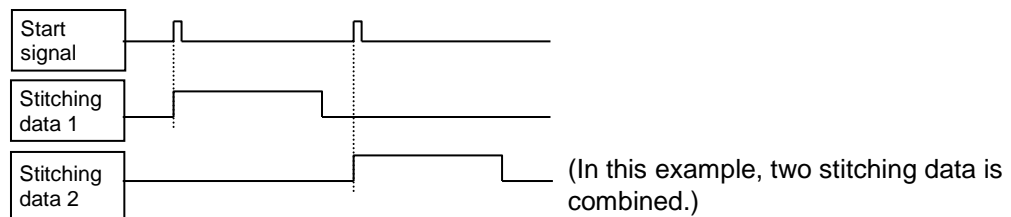

**Docking :** It is possible to connect some stitching data. It is a function that ties some stitching data like one data to sew with the specification order. Because it treats like one data after the start signal input, it sews continuing individual data one after another.

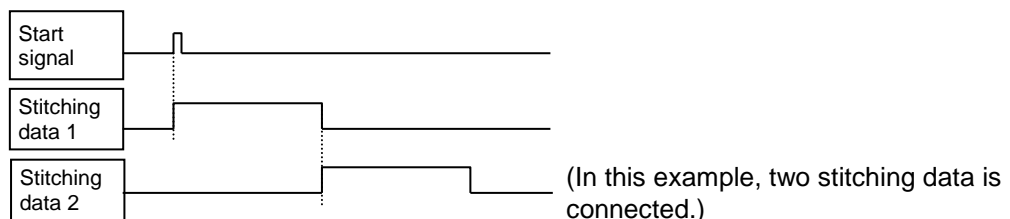

■ Specifying combination data

(1) Enter the combination function to press the key  on the function mode screen.

(2) Select place where data is set (  )

and then press the key  (Please stuff ahead sequentially and set the stitching data.)

(3) Select the stitching data that wants to add to the combination, and then press the key  .

**Note** From among the data stored in an internal memory, up to 20 stitching data items can be added to the combination. It can not add the stitching data that input second home position cord.

(4) Stitching data (No.0800 in this example) has been added.

(5) Using the procedure explained in (2) and (3), data items can be added to the combination. (No.0801 and 0802 in this example)

(6) To write the created combination data into the internal memory, press the key  .

The combination data can not be used without writing it into the internal memory.

The combination data which is written into the USB memory must read from the USB memory before combining.

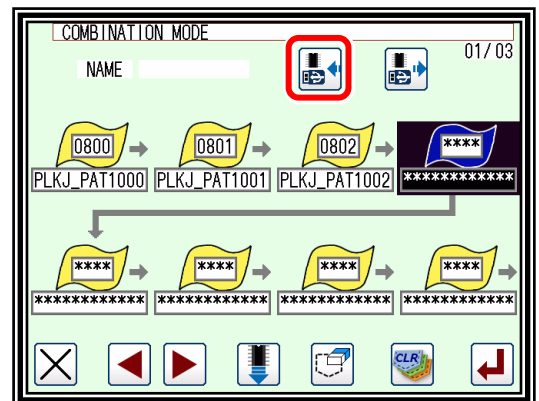
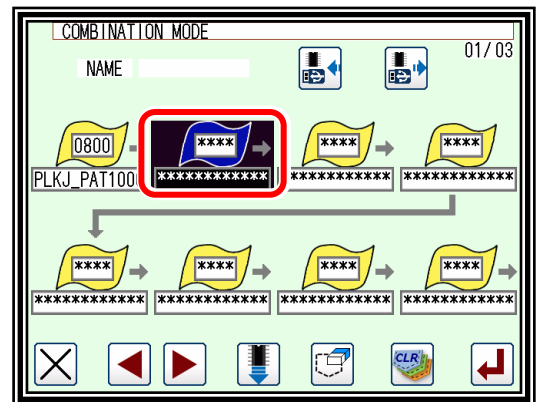
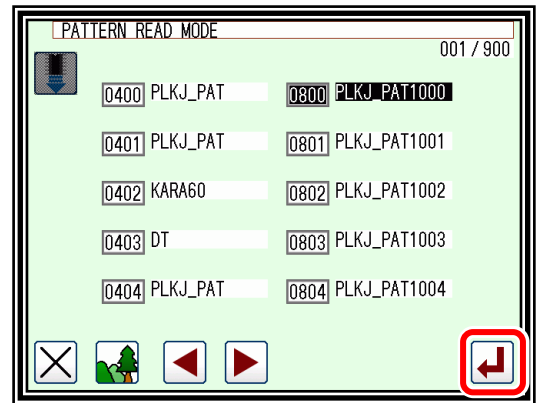
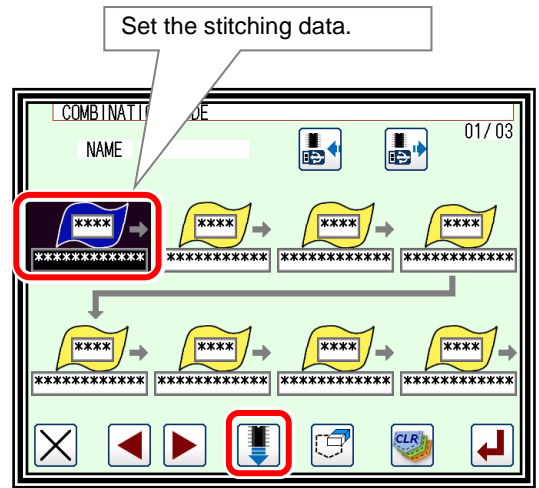



- (7) Input name and select form of the combination data at the combination data writing function.  
(Refer to the page [5] - 7.)

Form



: combination



: docking

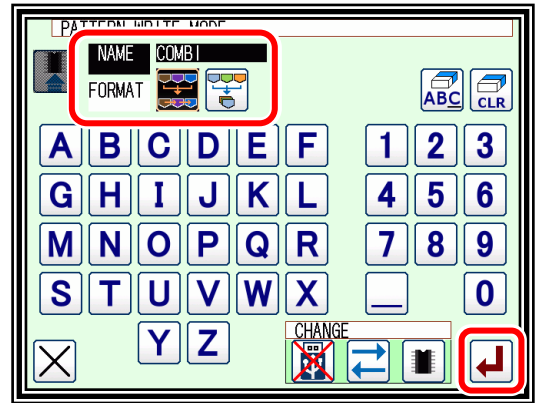

- (8) Press the key  after selection.

- (9) Display returned and the name of combination data is displayed on the operation panel.  
At that time, the combination data was written into the memory.

- (10) When sewing after this operation, press the key . (It can not be sewn on this display.)

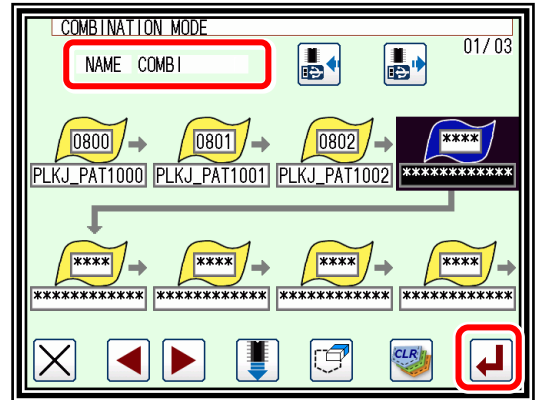

**Note** If the key  is pressed at this screen, it cancels the data that was set in this mode.

- (11) Press the key  on the function mode screen and return to the standard screen.

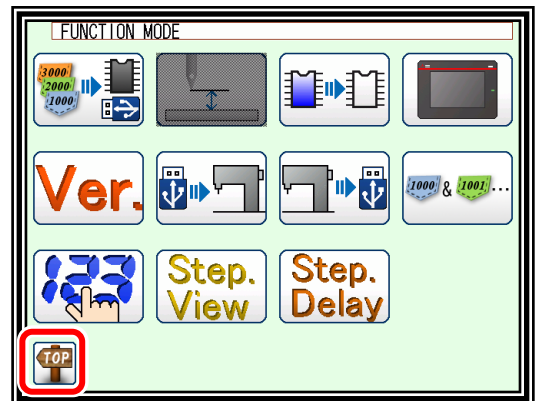

- (12) It can be confirmed in the standard screen that the combination data is set. (\*1)

- (13) Inputting the start signal, it can be started sewing the combination data.

The icon under the image area is changed to the combination data.

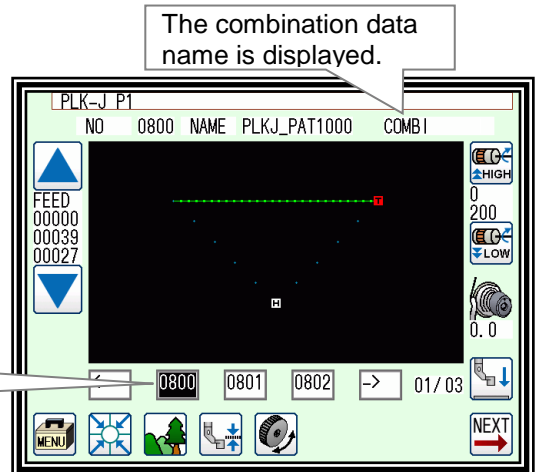

(\*1) When using the combination data, it is impossible to use usual stitching data.  
If the setting is returned to normal operation, it is necessary to release the combination data.  
It explains the method of releasing the combination data by the following chapter.

■ Releasing combination data

(1) Enter the combination function to press the key



on the function mode screen.

(2) Press the key  on the combination mode screen.

(3) Press the key  after displaying the confirmation message.

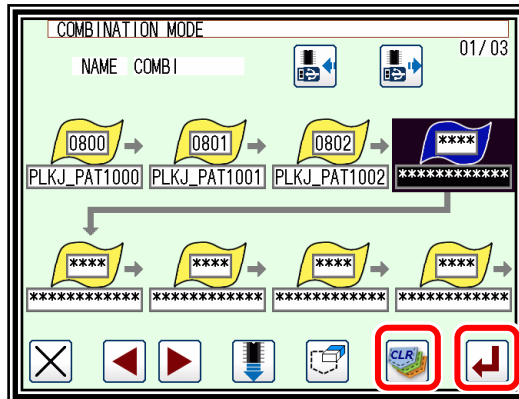

No display of combination data name

(4) Display changed without combination setting, press the key  without fail.

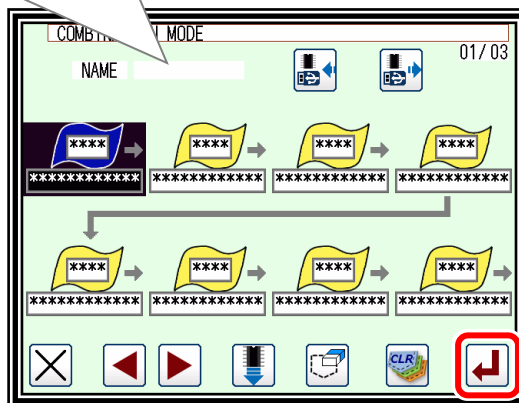

**Note** If the key  is pressed at this screen, it cancels the combination releasing.

(5) Press the key  on the function mode screen and return to the standard screen.

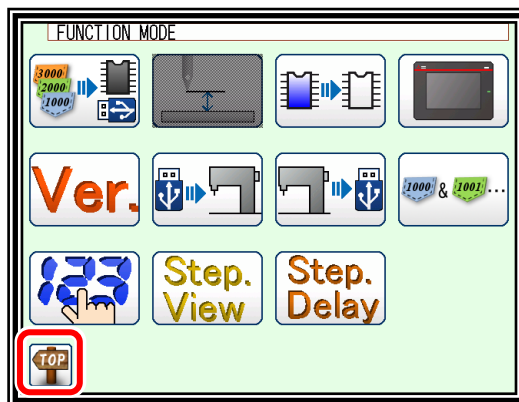

(6) It returns to the standard screen. It is release of the combination data setting completion.

The combination data name is not displayed.

The icon under the image area is changed to the stitching data.

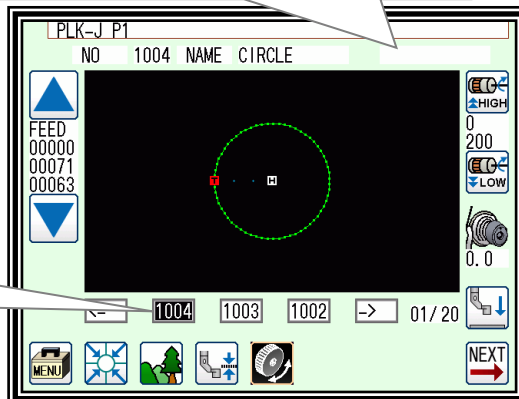

■ Reading combination data

(1) Enter the combination function to press the key





on the function mode screen.

**Note** When the combination function has already been set, execute reading after releasing combination data. (Please refer the item of Releasing combination data.)

(2) Press the key  to read.

(3) Select the combination data for the purpose intended after changing into the function screen for reading combination data.

The screen can be changed into the individual type such as  combination and  docking.

(4) Press the key  after selection.

(5) USB

► Specify the format to be specified, select the combination name to be read, and press .

► Push the folder name into the folder.

► Press  or  to switch pages.

► Moved into folder

Press  to return to the next higher folder hierarchy.

Select the combination name to be read, and press



Combination data name (no folder)

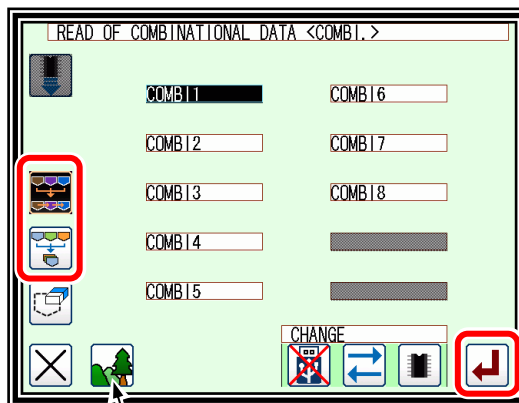
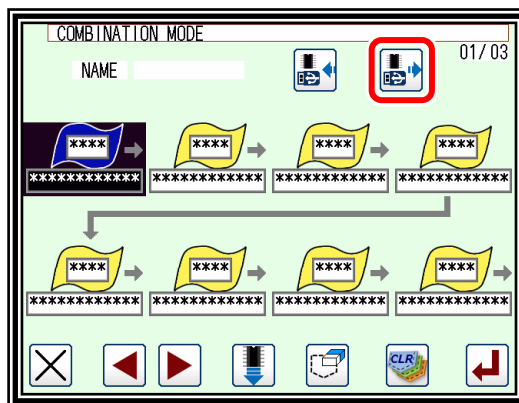

If pressing the button, the image of the combination data is displayed. (\*2)

Combination data name (no folder)

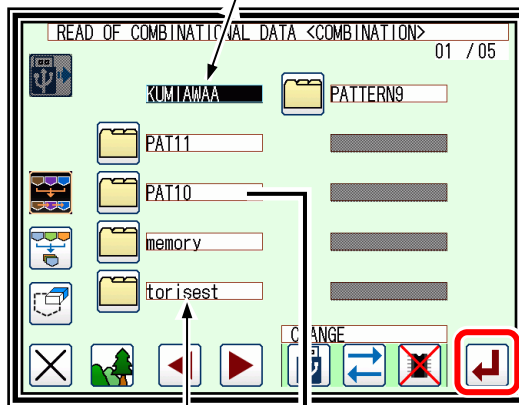

Folder name

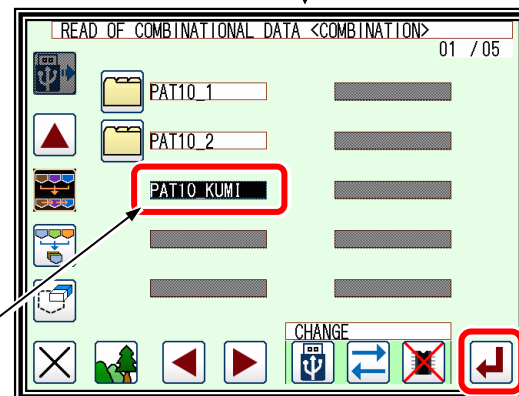

(6) The combination data has been read.

When pressing the key  to do the sewing operation, the standard screen will be returned as the above-mentioned procedure.

**Note** If the key  is pressed at this screen, the combination data that has been read can be cancelled.

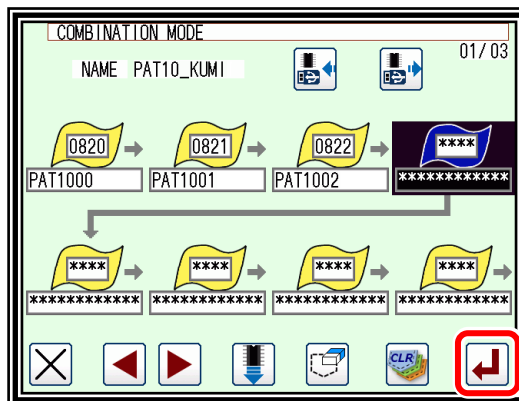

**Note** The sewing data in the USB memory is overwritten in the internal memory when you read the combination data from the USB memory, when the same sewing data related to the combination data exists. In this case, the message of confirmation is displayed, please operate carefully.

(\*2)  The imaging display of the combination data.

When the icon displayed on the read screen for the combination data is pressed, the screen as shown on the right figure will be displayed to confirm the formation of the combination data, which is different from the screen which shows the usual image of sewing data.

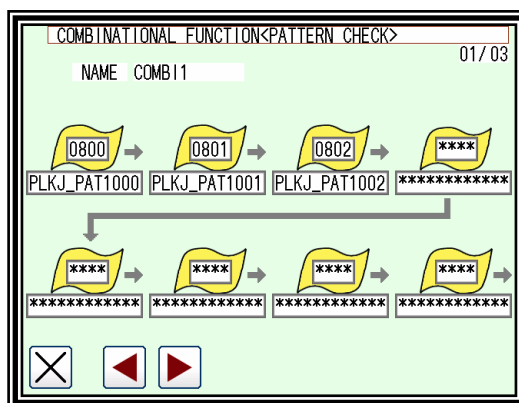

## ■ Editing combination data

It explains the method of adding and deleting the combination data. It is necessary to write the combination data after editing. (Refer to page [14] - 6.)

### Delete

- (1) The data that wants to be deleted is selected on the combination mode screen.

Select it

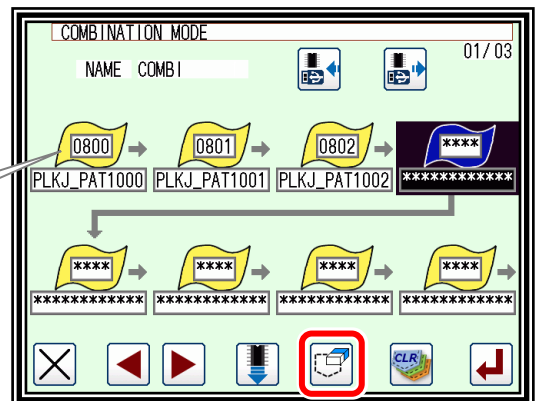

- (2) Press the key

- (3) The selected combination data will be deleted and shifted to the left one by one. Stitching data (No.800 in this example) have been deleted.

— Deletion operation end —

— Save combination data after editing—

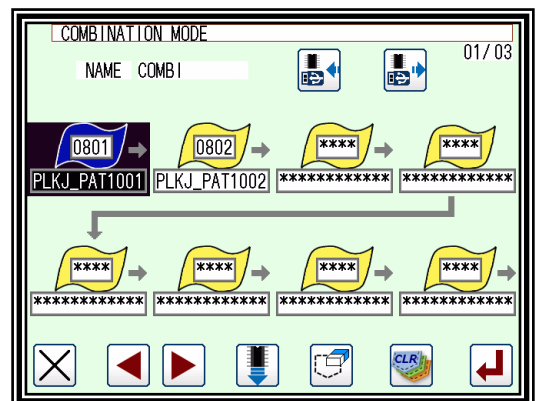

### Insert

- (1) The place that wants to be inserted is selected on the combination mode screen.

- (2) Press the key

Select the place

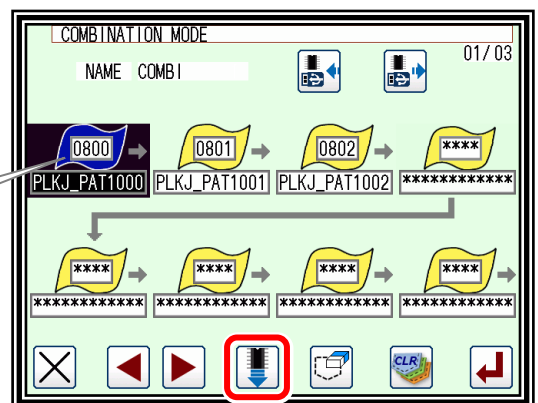

- (3) Select the stitching data which you want to add to the combination, and then press the key

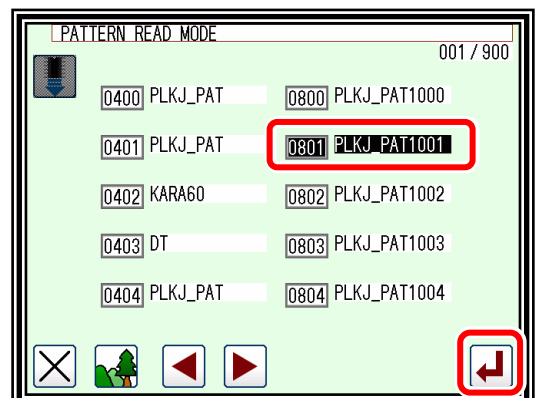

- (4) The selected combination data will be inserted and shifted to the backward one by one. Stitching data (No.801 in this example) has been added.

— Insertion operation end —

— Save combination data after editing —

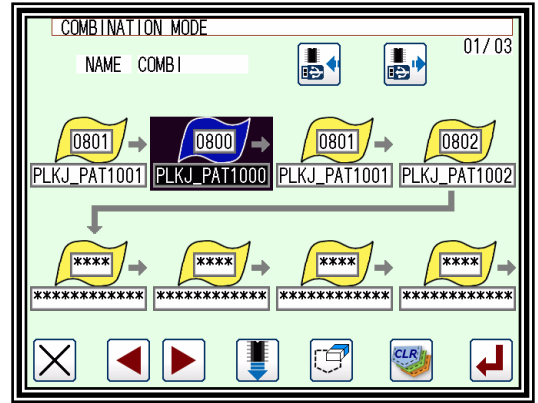

### ■ Deleting combination data

- (1) Press the key  on the combination mode screen.

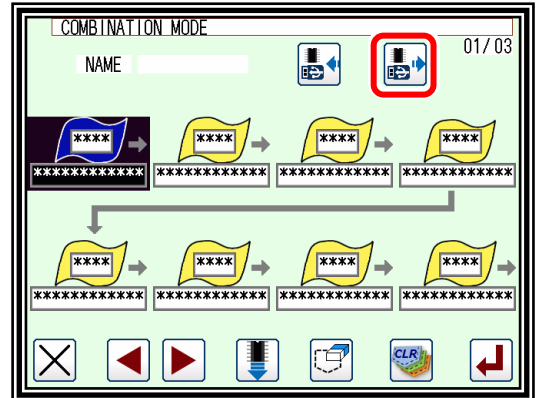

- (2) The data that wants to be deleted is selected on the reading combination data screen. (Refer to the page [5] - 3.)

- (3) Press the key  after selection.

Select it

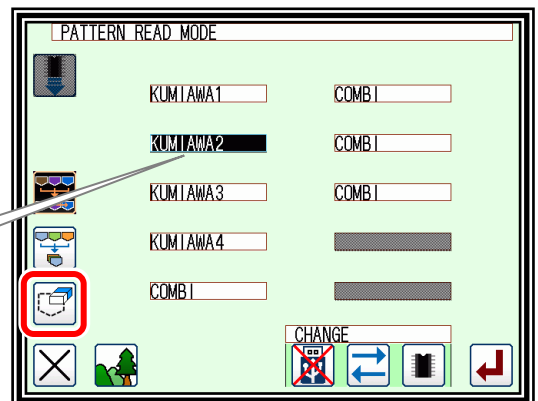

- (4) Press the key  after displaying the confirmation message.

- (5) Press the key , it returns to the former screen.

— Deletion operation end —

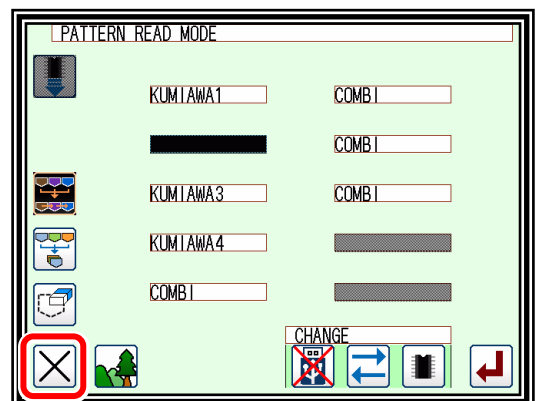

■ Precaution of the combination data

The individual sewing data comprising the combination data have to exist in the internal memory to sew the combination data.

If the sewing starts under the condition that the sewing data comprising the combination data have been deleted, the message will be displayed at the point which is nonexistent sewing data and the sewing operation will stop.

As a countermeasure, return the deleted data into the internal memory from the USB memory saved for backup or save it again after deleting the combination data if not required.

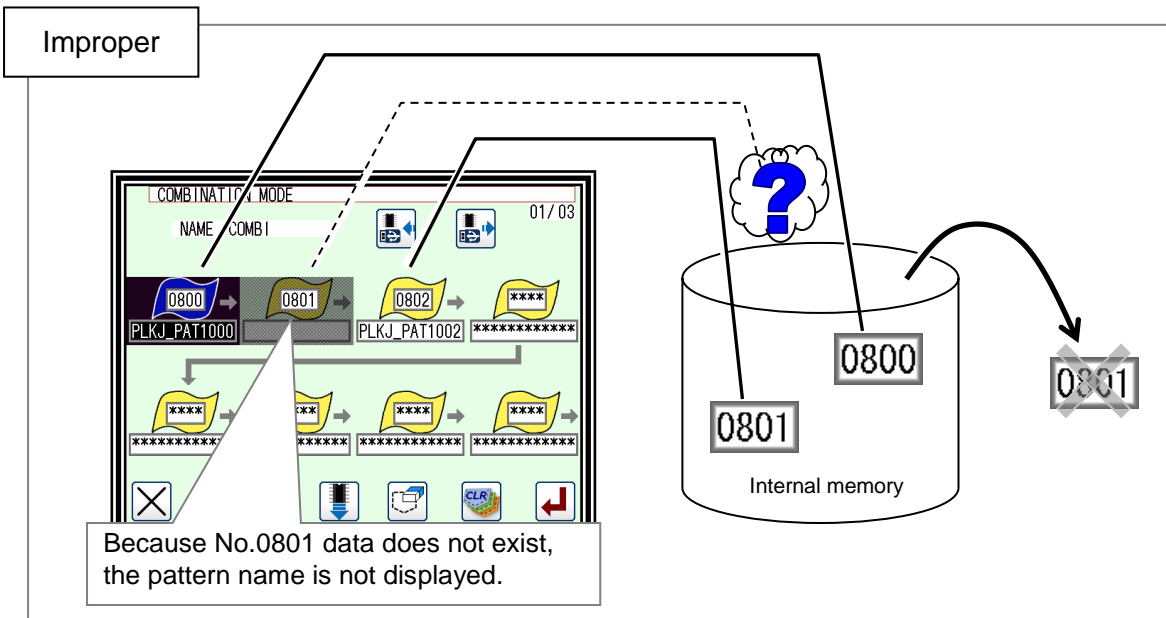
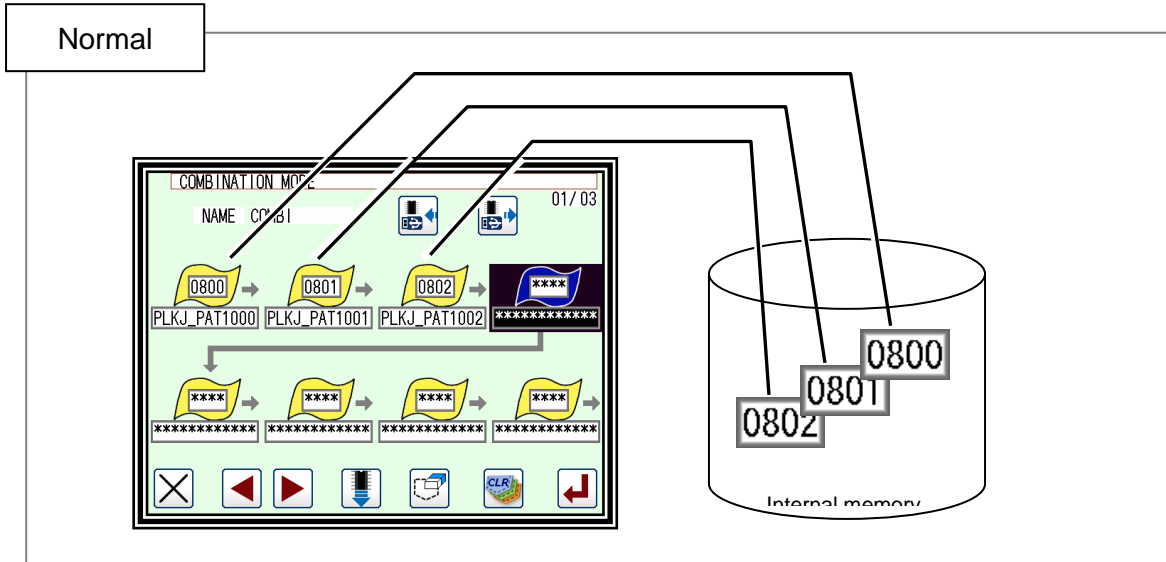

# [15] Input/output setting mode

## 1. Outline

### ■ List of input/output setting modes



Input signal confirmation.  
( ‡ Be careful! The sewing machine is ready for operation.)



Output signal confirmation.  
( ‡ Be careful! The sewing machine is ready for operation.)



Motor angle / Home position Sensor / Temperature display.  
( ‡ Be careful! The sewing machine is ready for operation.)



Input setting. (Custom input)



Output confirmation. (Custom output)

### ■ Entering the input/output setting mode

▶ Press  and  on the Standard screen, and open the Input / Output Setting Mode screen.

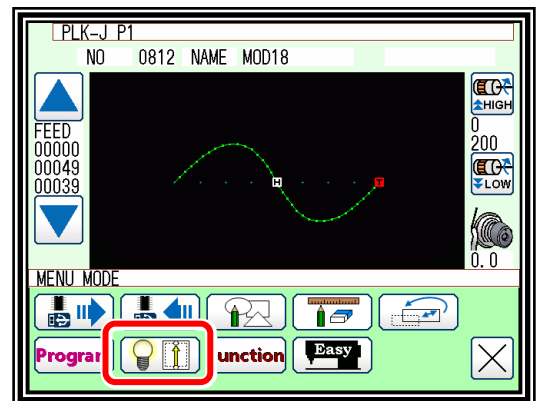

### ■ Input / Output Setting Mode screen

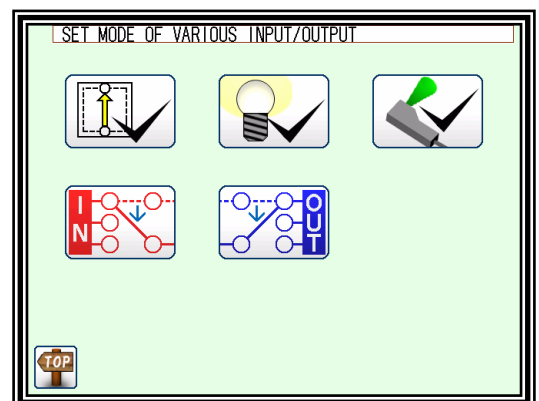





## 2. Explanation of input/output setting mode



Input signal confirmation

Pressing   will move the outer presser and  
The ON/OFF status of the input signal can be confirmed.



Indicates that the input signal is ON.



Indicates that the input signal is OFF.

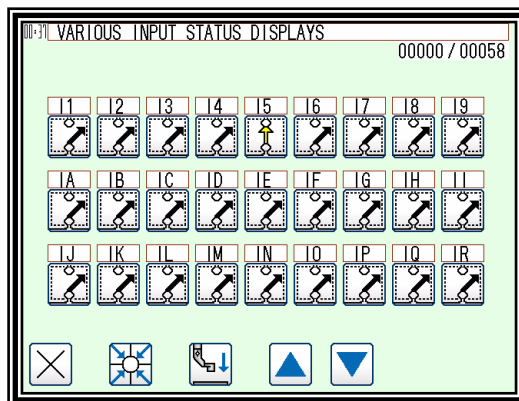

**Note** Input ON/OFF display might be concealed by the error message's giving priority according to the kind of the input or other conditions and being displayed.





**Caution** Be careful! The sewing machine is ready for operation.



Output signal confirmation

The output signal can be confirmed.  
The [1] Status reference mode and the [2] Test output mode are available. Press the mode changeover icon to change the screen.

[1] Status reference mode.

Pressing   will move the outer presser  
and The current output status can be confirmed.



Indicates that the output signal is ON.



Indicates that the output signal is OFF.

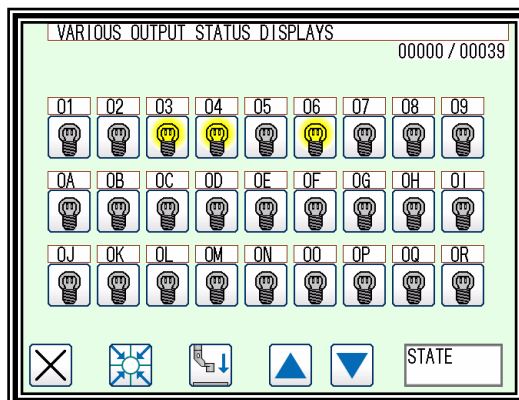

[2] Test output mode.

The signal for which the icon is pressed will be output as a test.



Indicates that the output signal is ON.



Indicates that the output signal is OFF.

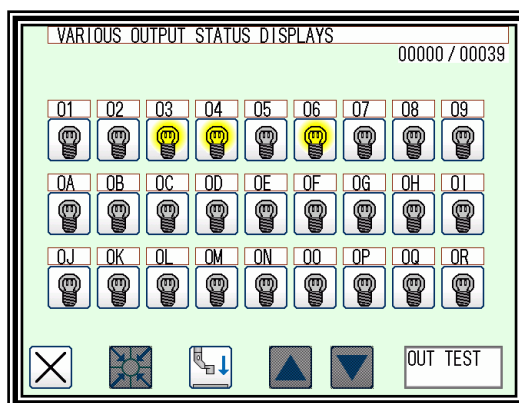

**Note** Output ON/OFF display might be concealed by the error message's giving priority according to the kind of the output and other conditions and being displayed.



**Caution** Be careful! The sewing machine is ready for operation.



**Caution** Be careful! Please not to bring the hand close to the sewing machine for safety while confirming the output signal.



## Motor angle • home position Sensor • Temperature

When entering this mode, you can check the angle of each axis and sensor detection.

•The detector angle is the angle from the detected UP position.



This means detection.



This means non-detection.

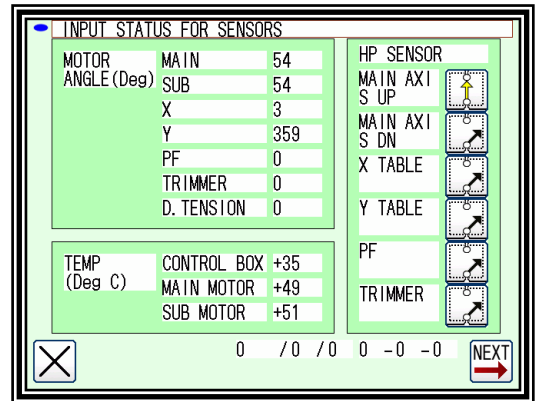

**Note** Each display might be concealed by the error messages giving priority according to the situation and being displayed.

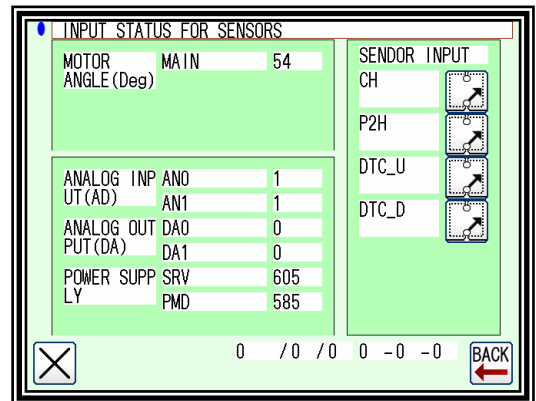

**Caution** Be careful! The sewing machine is ready for operation.



## Input setting



(Custom input) [Password function]

(1) Input Customize Setting screen.

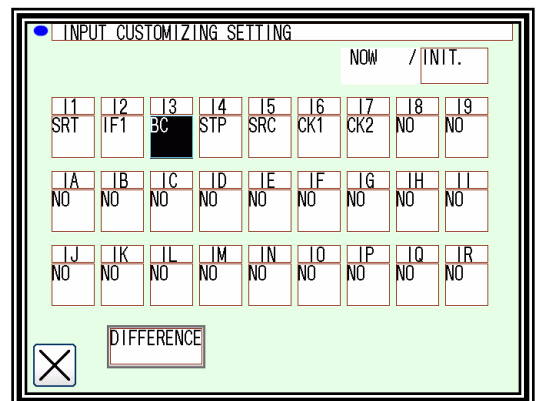
- ▶ Press the physical input RAM (I1 to I9, IA to IR) to be customized. The Function Section screen will open.
- ▶ Box which setting is changed from initial setting is displayed in reverse.



(2) Function Selection screen.

- ▶ Press the   icons and select the signal type. (In this case, "SRT" is selected.) (Refer to "3. Input signal setting table" for details on the signal types.)
- ▶ To make detailed settings, press the "Details setting" icon.

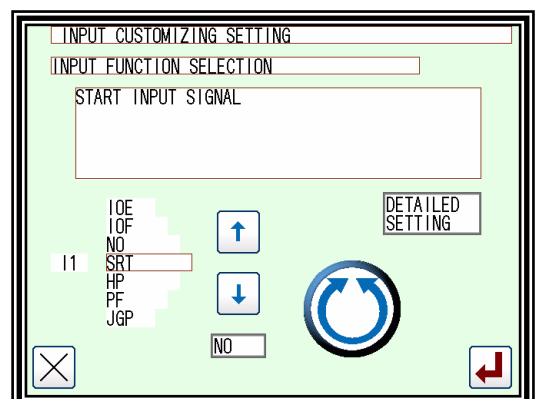

(3) Details Setting screen.

- ▶ Change the logic of the input signal. (Normal/reversed)
- ▶ Change the operation of the input signal. (Normal/alternate)
- ▶ Press the  to fix the setting. (The previous screen will open.)

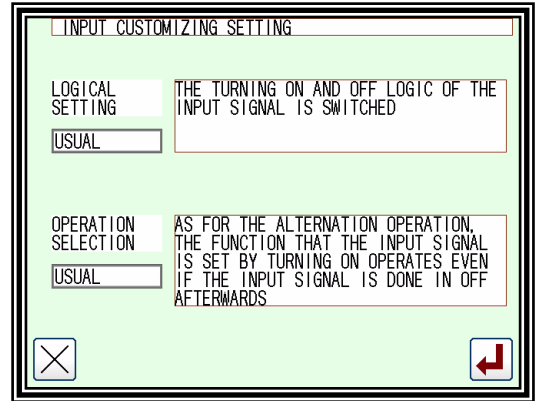

**Note** Refer to technical manual [Control unit] "[8] customized input/output" for details on the signal logic and operation.





Output confirmation (Custom output) [Password function]

(1) Output Customize Setting screen.

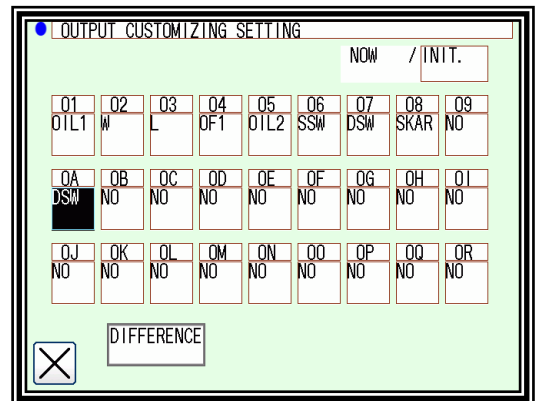
- ▶ Press the physical output RAM (O1 to O9, OA to OR) to be customized. The Function Section screen will open.
- ▶ Box which setting is changed from initial setting is displayed in reverse.



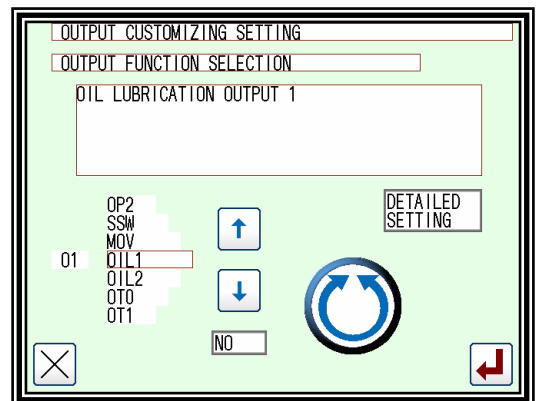

(2) Function Selection screen.

- ▶ Press the   icons and select the signal type. (In this case, "OIL1" is selected.) (Refer to "4. Output signal setting table" for details on the signal types.)
- ▶ To make detailed settings, press the "Details setting" icon.



(3) Details Setting screen 1.

- ▶ Change the logic of the output signal. (Normal/reversed)
- ▶ Change the operation of the output signal. (Normal/alternate)
- ▶ The Details Setting screens 1 to 3 are available. Press   to change the screen.

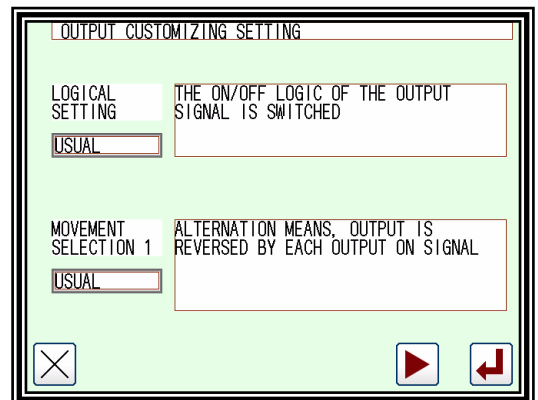

(4) Details Setting screen 2.

- ▶ Set the chopping duty. (Eight types)
- ▶ Set the full wave output time. (0 to 6553.5ms)

**Note** Refer to technical manual [Control unit] "[8] customized input/output" for details on the signal logic and operation.

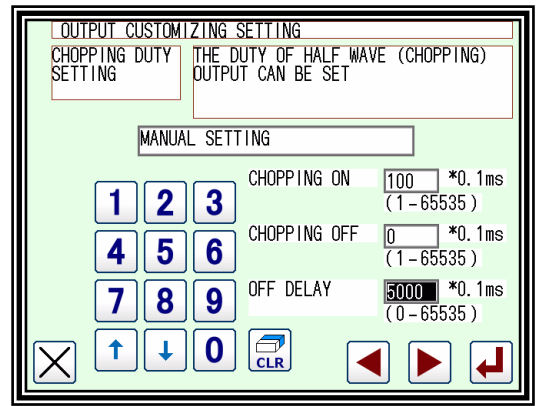

(5) Details Setting screen 3.

- ▶ Set the ON delay. (Valid/Invalid, delay time (0 to 6553.5ms))
- ▶ Set the OFF delay. (Valid/Invalid, delay time (0 to 6553.5ms))
- ▶ Press the  to fix the setting. (The previous screen will open.)

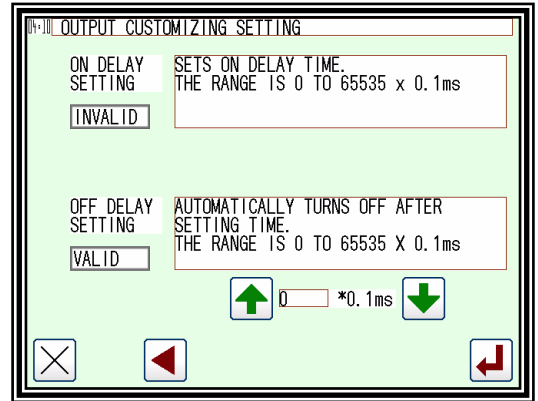

**Note** You can compare it with the reading value of the setting file and change the reference value from the difference list to the current value. (Refer to Page [14] - 4 "Setting file read")

Switch by pressing the **INIT.** and **REF.** icons.

Output customization screen

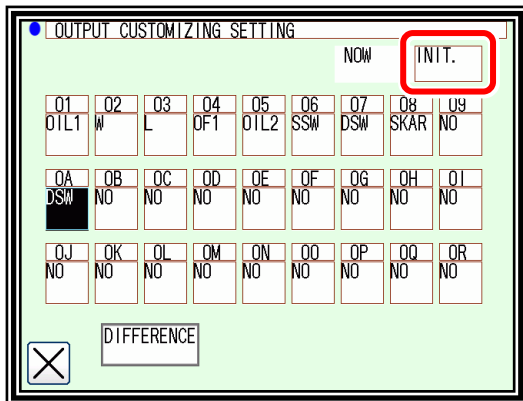

Comparison with initial value

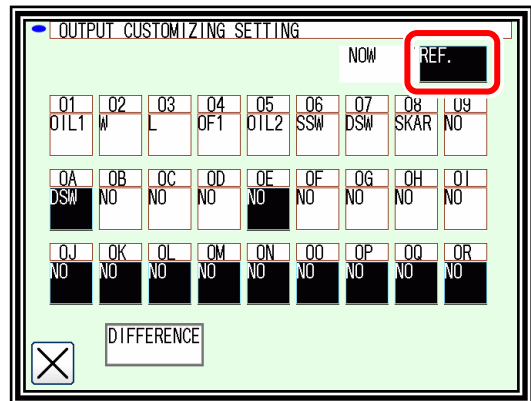

Comparison with reference value

The reference value differs from the current value in the opposite direction. Press the **DIFFERENCE** icon and select the output to change to the reference value. When the power is turned off, the reference value is not displayed, so reloading is necessary.

Input customization can be compared in the same way.

### 3. Input signal setting table

Code	Function	Specifications
FSP	Clamp all step ON signal	Whenever FSP input is on, clamp output [1],[2],[3],[4] turned on one by one. However, when [ Program mode > Clamp output > number of effective clamp (FN) ] is set to 1, FSP input is ineffective.
FSM	Clamp all step OFF signal	Whenever FSM input is on, clamp output [4],[3],[2],[1] turned off one by one. However, when [ Program mode > Clamp output > number of effective clamp (FN) ] is set to 1, FSM input is ineffective.
IFR	All clamp output clear signal	If IFR signal is on, all clamp outputs are turned off.
A2F	Pneumatic two-step clamp switch input signal	Whenever A2F input is on, following operation (1), (2), (3) is repeated. This signal is effective when [Program mode > Setting for Pneumatic two-step clamp (AF2)] is on. <div style="border: 1px solid black; padding: 5px; margin: 5px 0;">                     (1) When A2F input is on first time, AFL output is turned on.                      (2) When A2F input is on second time, AFH output is turned on.                      (3) When A2F input is on third time, AFE output is turned on.                 </div>
IF1 to IF4	Clamp input signal 1 to 4	When IF1 input is on, OF1 output is turned on. When IF1 input is on again, OF1 output is turned off. (same from IF2 to IF4)
F1C to F4C	Clamp output prohibition signal 1 to 4	When F1C input is on, OF1 output is prohibited. (same from F2C to F4C)
OFC	All clamp output cancel signal	When OFC input is on, OF1 to OF4 outputs are prohibited.
WC	Wiper output cancel signal	When WC input is on, W output is prohibited.
TC	Trimmer output cancel signal	When TC input is on, Thread trimmer sequence output T, L and W is prohibited.
S6	Thread trimming protection signal	When S6 input is on while machine is driving, the machine is stopped and when S6 input is off, the machine start driving again. When S6 input is on while thread trimming operation, machine is stopped after trimming.
HPC	Home positioning prohibition signal	When HPC is ON, home returning operation by the home positioning icon or HP signal is prohibited.
THS	Upper thread sensor input signal	When setting of [ Program mode > Needle thread breaking sensor ON/OFF ] is on, the signal can be used for thread breakage detection input.
ARS	Less pressure detection signal	When ARS input is on, all operation is interrupted, and error [E-3108] is displayed. (Returns by power supply re-turning on.)
IO0 to IOF	General purpose input 0 to F	When IO0 input is on, OT0 output is turned on at the same time. (same from IO1 to IOF)
NO	No operation signal	Anything does not operate, if NO input is turned on.
SRT	Start signal	When SRT input is on, sewing operation is started. However, when clamp output is turned off, this signal is invalid.
HP	Home position returning signal	When HP input is on, home position returning operation is executed. However, please note there is a timing that becomes invalid, for example while machine is running.
PF	Presser foot signal	When PF input is on, The presser foot will return to home position. When PF input is on again, presser foot goes to down position.
JGP	JOG plus signal	When JGP input is on, XY table is moved in positive direction according to the pattern.
JGM	JOG minus signal	When JMG input is on, XY table is moved in negative direction according to the pattern.
STP	Halt signal	When STP input is on, machine is stopped.
BC	Fixed angle (rotation/reverse rotation) signal	To confirm the needle thrust position, the needle is stopped just before the sewing material. Whenever BC input is ON, operation of [rotation] -> [reverse rotation] -> [rotation] is repeated. When the start switch is on afterwards, following sewing operation is started. However, if the following data is non stitch feed, the message [M-020] is appeared, in this case please move the needle to up position and re-turning on the start switch.
CCL	Counter clear signal	When CCL input is on, UP/DOWN counter is cleared.

< Sequel to INPUT SIGNAL >

Code	Function	Specifications
SRC	Start cancel signal	When SRC input is on, sewing operation with Stringhalt is prohibited.
CCU	Up counter clear signal	When CCU input is on, UP counter is cleared.
CCD	Down counter clear signal	When CCD input is on, DOWN counter is cleared.
UAD	Up counter addition signal	When UAD input is on, 1 is added to UP counter.
UDC	Up counter subtraction signal	When UDC input is on, 1 is subtracted from UP counter.
DAD	Down counter addition signal	When DAD input is on, 1 is added to DOWN counter.
DDC	Down counter subtraction signal	When DDC input is on, 1 is subtracted from DOWN counter.
KNK	Signal that invalidates MENU icon	When KNK is on, "MENU" icon becomes invalid.
RNK	Signal that invalidates "pattern read" icon	When RNK is on, "pattern read" icon becomes invalid.
WNK	Signal that invalidates "pattern write" icon	When WNK is on, "pattern write" icon becomes invalid.
INK	Signal that invalidates "teaching input" icon	When INK is on, "teaching input" icon becomes invalid.
MNK	Signal that invalidates "teaching modification" icon	When MNK is on, "teaching modification" icon becomes invalid.
CNK	Signal that invalidates "teaching conversion" icon	When CNK is on, "teaching conversion" icon becomes invalid.
PNK	Signal that invalidates "program mode" icon	When PNK is on, "program mode" icon becomes invalid.
NNK	Signal that invalidates "IN/OUT setting" icon	When NNK is on, "IN/OUT setting" icon becomes invalid.
FNK	Signal that invalidates "function mode" icon	When FNK is on, "function mode" icon becomes invalid.
SNK	Signal that invalidates "speed" icon	When SNK is on, "speed" icon becomes invalid.
HNK	Signal that invalidates "PF height setting" icon	When HNK is on, "PF height setting" icon becomes invalid.
DHK	Signal that invalidates "digital tension gauge" icon	When DHK is on, "digital tension gauge" icon becomes invalid.
ENK	Signal that invalidates "easy setting" icon	When ENK is on, "easy setting" icon becomes invalid.
P3NK	Signal that invalidates "Standard screen 3" icon	When P3NK is on, "Standard screen 3" icon becomes invalid.
P01	Pattern number switch signal +1	When P01 is on, pattern data number is switch to 1001 (1000 + 1).
P02	Pattern number switch signal +2	When P02 is on, pattern data number is switch to 1002 (1000 + 2).
P04	Pattern number switch signal +4	When P04 is on, pattern data number is switch to 1004 (1000 + 4).
P08	Pattern number switch signal +8	When P08 is on, pattern data number is switch to 1008 (1000 + 8).
P16	Pattern number switch signal +16	When P16 is on, pattern data number is switch to 1016 (1000 + 16).
P32	Pattern number switch signal +32	<p>When P32 is on, pattern data number is switch to 1032 (1000 + 32).</p> <div style="border: 1px solid black; padding: 5px; margin: 5px 0;"> <p>&lt; When you want to change to other patterned numbers &gt;</p> <p>ex.1) pattern number to 1003 turns on P01 input and P02 input <math>P01 (+1) + P02 (+2) + 1000 = 1003</math></p> <p>ex.2) pattern number to 1011 turns on P01, P02 and P08 input <math>P01 (+1) + P02 (+2) + P08 (+8) + 1000 = 1011</math></p> </div> <p>‡ Pattern number can be changed within the range from 1000 to 1063. ‡ P01, P02, P04, P08, P16, P32 is effective when [Pattern select function by external signal (APC)] has been set to ON. Pattern number is able to set to 1000,2000,3000,4000 by program mode "POF".</p>

< Sequel to INPUT SIGNAL >

Code	Function	Specifications
HES	Machine head tilting detection signal	When HES input is on, message [M-038] is displayed.
SP0 to SP9	Speed dial signal	Speed dial value is switched to 0 to 9.
SPU	Speed up signal	Speed dial value is increased +1.
SPD	Speed down signal	Speed dial value is decreased -1.
CK1	Cassette jig sensor 1 signal	When CK1 and CK2 inputs is on, OF1 output turn on.
CK2	Cassette jig sensor 2 signal	‡ CK1 and CK2 is effective when [Cassette jig function ON/OFF(CHK)] and [Cassette jig sensor ON/OFF(CSN)] has been sets to ON.
BCDR	Barcode reading input signal	When input BCDR is turned ON, the pattern can be read with a barcode. This signal is effective when Program mode [Communication (UBCT)] is OFF.
DFCR	Input signal of material Thickness detection clear	Material thickness detection OK Output signal (DFOK), material thickness detection NG output signal (DPNG, DNNG) are turned OFF.
SKCR	Input signal of abnormal stitch detection clear	Turn off abnormality stitch detection OK output signal (SKOK) and abnormality stitch detection NG output signal (SKNG).
S2CR	Input signal of abnormal stitch detection 2 clear	Turn off abnormality stitch detection 2 OK output signal (S2OK) and abnormality stitch detection 2 NG output signal (S2NG).

## 4. Output signal setting table

Code	Function	Specifications
OT0 to OTF	Virtual output 0 to F	When IO0 is on, OT0 output at the same time(same from OT1 to OTF )
FN1 to FNH	Function code output 1 to H	When FUN1 code is read while sewing operation, FN1 output is reversed. (same from FN2 to FNH )
OF1 to OF4	Clamp output 1 to 4	When IF1 is on, OF1 output is reversed (same OF2 to OF4 )
NO	[NO]output	Nothing is done.
T	Trimmer output	Trimming operation is done.
L	Thread tension release output	Thread tension release operation is done.
W	Wiper output	Wiper operation is done.
PF	Presser foot output	Presser foot operation is done.
AFL	Pneumatic two-step switch clamp low pressure output	When A2F input is on first time, AFL output is turned on. Setting is effective when [ Program mode > Clamp > Pneumatic two-step switch clamp ON/OFF (AF2)] is on.
AFH	Pneumatic two-step switch clamp high pressure output	When A2F input is on second time, AFH output is turned on. Setting is effective when [ Program mode > Clamp > Pneumatic two-step switch clamp ON/OFF (AF2)] is on.
AFE	Pneumatic two-step switch clamp excess pressure release output	When A2F input is on third time, AFE output is turned on. Setting is effective when [ Program mode > Clamp > Pneumatic two-step switch clamp ON/OFF (AF2)] is on.
DHP	Home position output	When XY table is stopped on the home position, DHP output is turned on.
D2H	Second home position output	When XY table is stopped on the second home position, D2H output is turned on.
RED	Preparation ready output	When the machine is ready state (when clamp output is on), RED output is turned on. When machine is start sewing, RED is turned off.
DSW	Sewing in progress output	When the machine is sewing, DSW output is turned on. When machine is stopping on the home position, DSW output is turned off.
SP	Sewing machine rotation start output	After non stitch feed, when the sewing machine start to rotate, SP output is turned on. When home positioning is executed, SP output is turned off.
TSE	Trimming start output	When trimming sequence (down position) is started, TSE output is turned on. When trimming sequence is finished (when all the outputs of T, L and W are turned off), TSE output is turned off.
END	Sewing completion output	When a sewing pattern operation is finished, END output is turned on. When the next sewing is started, END output is turned off.
DCS	Halt code output	When the halt code data (USTP, DSTP) is read while sewing, DCS output is turned on. When the machine restarts DCS output is turned off.
DST	Halt in progress output	When the machine is on halt state, DST output is turned on. When the machine restarts DST output is turned off. However, it is not output while stopping by the USTP code or the DSTP code.
HPO	Home returning in progress output	While the operation of home returning by the home positioning icon or HP signal, HPO output is turned on.
ERR	Error output	When the error or message is displayed on the operation panel, ERR output is turned on.
CUE	Count up completion output	When the current value of up counter is reached at counter set value, CUE output signal is turned on. When the current value is cleared, CUE output is turned off.
CDE	Countdown completion output	When the current value of down counter is reached at 0, CDE output signal is turned on. When the current value is initialized, CDE output is turned off.
DTS	Halt in progress output after upper thread sensor detection	When the machine is on halt state with thread breakage, DTS output is turned on. When the machine restarts, DTS output is turned off.
DRT	Sewing machine rotation in progress output	While the machine is rotating, DRT output is turned on. (includes rotation in winding mode)
DN	Down position output	When the needle is down position, DN output is turned on.
CB	Buzzer output	While the buzzer in the operation panel is on, CB output is turned on. (including count up/countdown message display)
UP	Up position output	When the needle is up position, UP output is turned on.
PWR	Power on output	While power supply is on, PWR output signal is turned on.



< Sequel to OUTPUT SIGNAL >

Code	Function	Specifications
PUS	Presser hoot home position output	While presser foot is on the home position, PUS output is turned on.
MSG	Message display output	When the message is displayed on the operation panel, ERR output is turned on.
OP1	Option output 1	Do not use.
OP2	Option output 2	Do not use.
SSW	Halt signal being on output	SSW is turned on during power supply is on. However, input signal STP turns on SSW is turned on with blinking.
MOV	Sending table's moving output signal	Turns on during XY table is moving.
OIL1	Oil output 1	When [OILV] setting is ON, OIL1 is output. Oil lubricate timing set by [OL1C] and [OL1T].
OIL2	Oil output 2	When [OILV] setting is ON, OIL2 is output. Oil lubricate timing set by [OL2C] and [OL2T].
SKAR	Air output for the abnormal stitch detection sensor	During automatic sewing, air for stitch abnormality detection is output. This signal is effective when Program mode [the stitch abnormality detection (SKCF)] or [the stitch abnormality detection 2 (S2CF)] is on.
SKCH	Output that is judging the abnormal stitch detection	SKCH output turns ON when operating checking about abnormality stitch. This signal is effective when Program mode [the stitch abnormality detection (SKCF)] is on.
SKTS	Test output of the abnormal stitch detection	When the sensor turns ON at the angle at which the stitch abnormality is judged, a test signal is output. This signal is effective when Program mode [the stitch abnormality detection (SKCF)] is on.
BDRD	Output where barcode pattern reading is completed	When reading the pattern number with the barcode it will be output. When sewing is started, the output turns OFF.
PKYC	Output where barcode pattern reading is waiting	When the bar code is ready to read the pattern number, it will be output. (PKY = ON and Pattern update incomplete)
SKNG	Abnormal stitch detection NG output	SKNG output turns ON when there are suspect of abnormality stitch. This signal is effective when Program mode [the stitch abnormality detection (SKCF)] is on.
SKOK	Abnormal stitch detection OK output	SKOK output turns ON When sewing is completed with no suspected abnormal stitch detected. This signal is effective when Program mode [the stitch abnormality detection (SKCF)] is on.
DPNG	Thickness detection NG(+side) output	DPNG output turns ON when material thickness is thicker than "Thickness setting parameter" at the thickness detection (DFTH) of sewing material.
DNNG	Thickness detection NG(-side) output	DNNG output turns ON when material thickness is thinner than "thickness setting parameter" at the thickness detection (DFTH) of sewing material.
DFOK	Thickness detection OK output	DFOK output turns ON when material thickness is within margin of error about "thickness setting parameter" at the thickness detection (DFTH) of sewing material.
ANT0	Analog input 0 judgement output	ANT 0 output turns ON when the input voltage of CON 10 "analog input 0" on the I / F board is greater than or equal to the program mode ANT 0 [threshold value setting of analog input 0] setting value
ANT1	Analog input 1 judgement output	ANT 1 output turns ON when the input voltage of CON 10 "analog input 1" on the I / F board is greater than or equal to the program mode ANT 1 [threshold value setting of analog input 1] setting value
S2NG	Abnormal stitch detection 2 NG output	S2NG output turns ON when there are suspect of abnormality stitch. This signal is effective when Program mode [the stitch abnormality detection 2 (S2CF)] is on.
S2OK	Abnormal stitch detection 2 OK output	S2OK output turns ON When sewing is completed with no suspected abnormal stitch 2 detected. This signal is effective when Program mode [the stitch abnormality detection 2 (S2CF)] is on.
S2CH	Angle for judgement on Abnormal stitch detection 2 output	S2CH output turns ON when operating checking about abnormality stitch. This signal is effective when Program mode [the stitch abnormality detection 2 (S2CF)] is on.

# [16] Program mode

**Note** For each function explanation, please refer to “section [19]”

## 1. Setting methods

### ■ Entering the program mode

► Press  and **Program** on the Standard panel, and open the Program Mode panel.

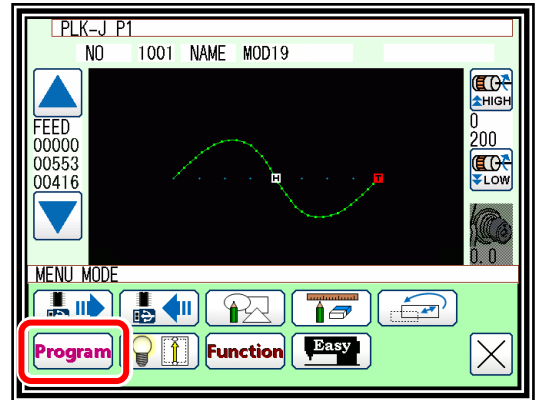

### ■ Program Mode panel

This panel is used to select the program mode. There are several mode selection pages.

Press the   icons to change the page.

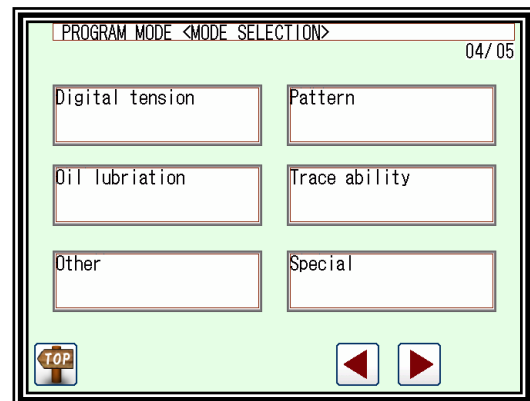
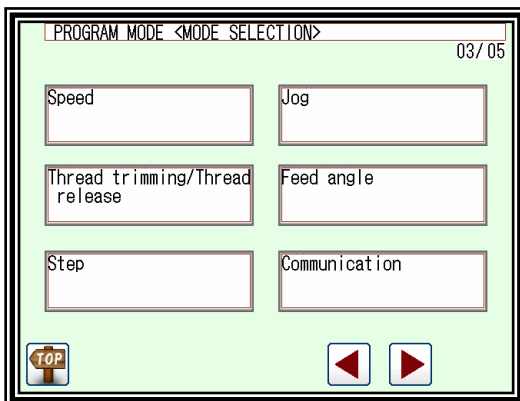
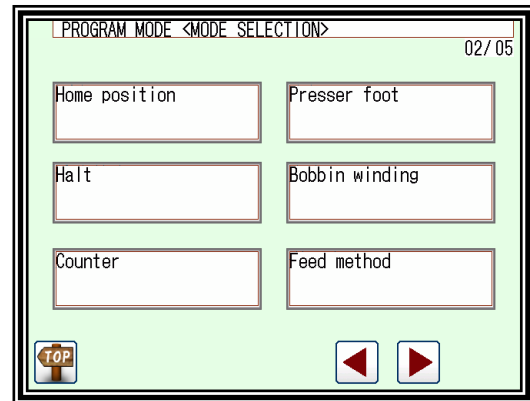
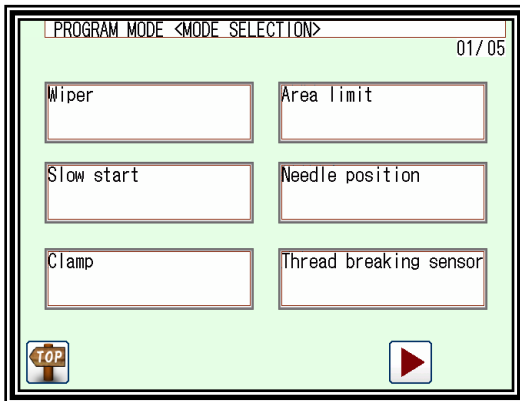

## ■ Example of setting

### (1) Selection of mode.

- ▶ When the icon for the mode to be set is pressed, the "Setting Selection panel" will open.  
(In this example, **HALT** is pressed.)

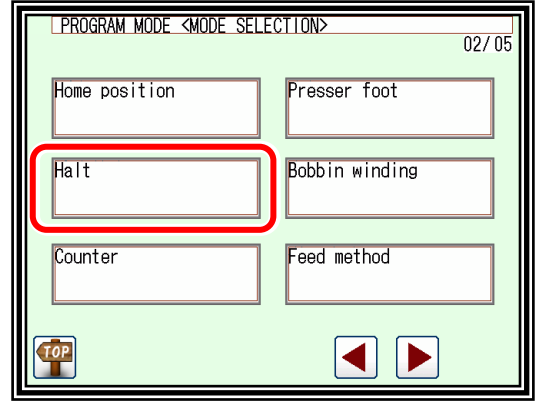

### (2) Selection of function.

- ▶ When the icon for the function to be set is pressed, the "Setting Value Change panel" will open.  
(In this example, **STF** is pressed.)

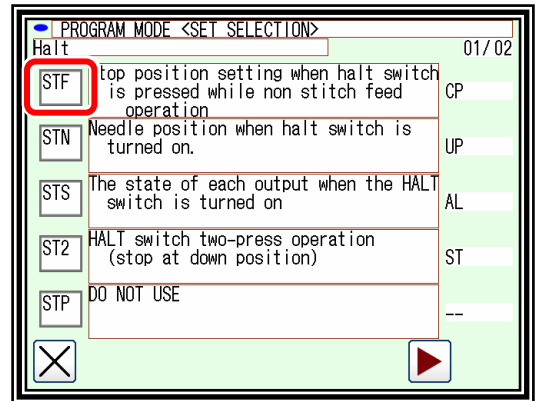

### (3) Changing setting value.

- ▶ After changing setting value (selecting status icon)  
(Here, pressing **ST**), press  to confirm setting.

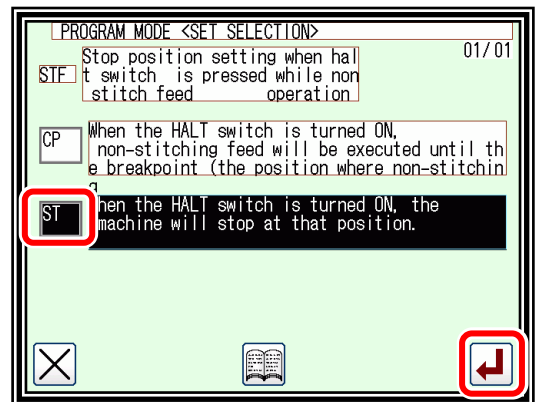

**Note** To show all explanation of these status icon, press



### (4) Checking function setting change.

- ▶ Return [Setting selection] window.  
After check setting value press .

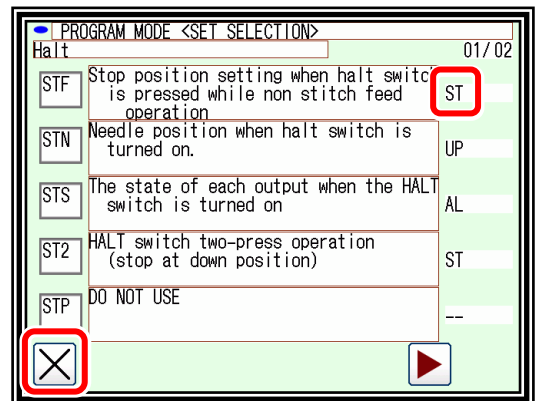

(5) Return to the mode selection screen.

▶ If some setting has been changed, **DIFFERENCE** icon will be appeared in the mode selection screen

▶ To return to the standard screen, press .

▶ To show different list, press **DIFFERENCE** icon.

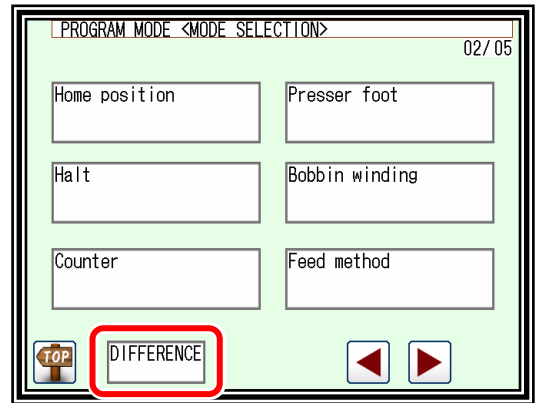

(6) Checking different list.

▶ Press **DIFFERENCE** icon.

▶ The list where the setting has been changed are displayed. Each list icons are selectable and setting value can be changed again from this screen.

▶ To initialize all settings, press **ALL**. To initialize only selected items, press the frame of the explanation (frame will be displayed in reverse), then press **SELECT**.

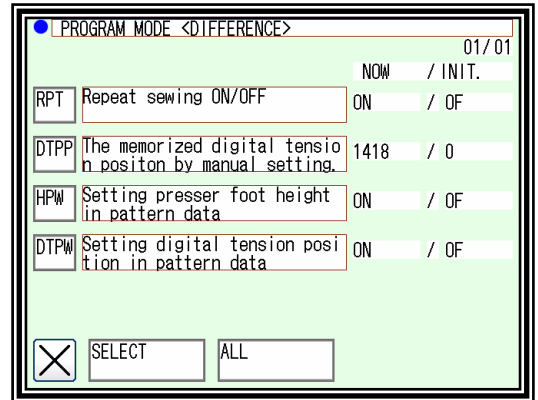

**Note** You can read the reference file data as a reference value and compare it with the current value. And you can also change the reference value to the current value. (Refer to Page [14] - 4 "Setting file read")

Press the **INIT** and **REF** icons from the **DIFFERENCE** icon to switch.

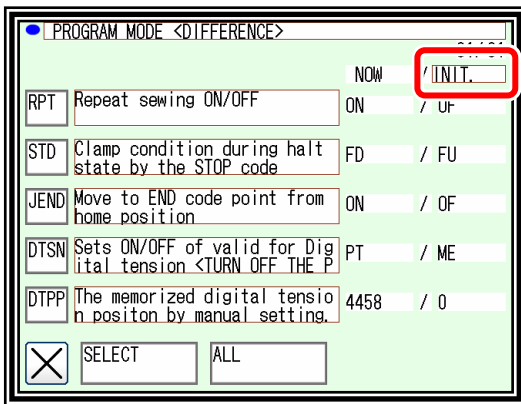

Comparison with initial value

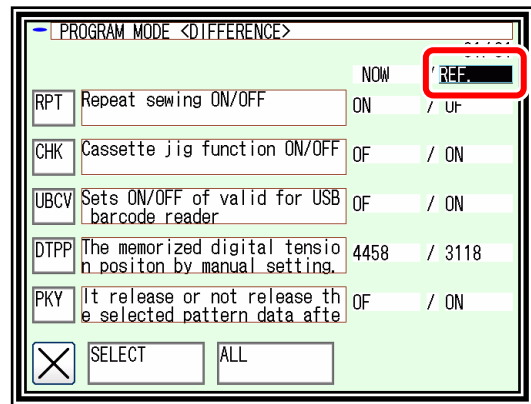

Comparison with reference values

**Note** Type of setting

There are few types of setting. One is status selection type like described above. Other is ON/OFF setting type, or numeral setting type. In the numeral setting type, numeric button will be appeared.

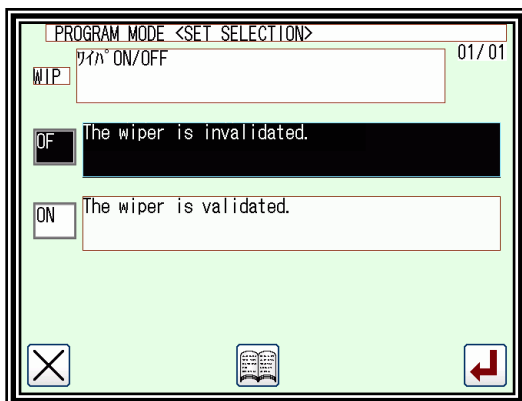

Example of ON/OFF setting type

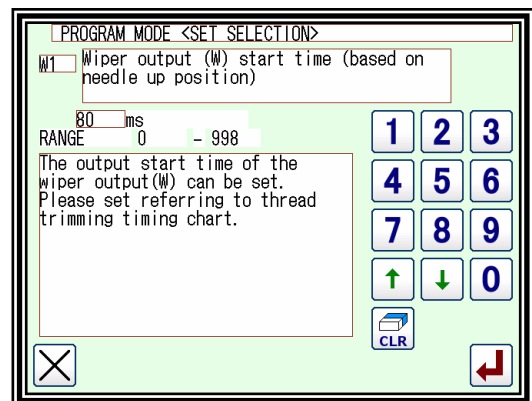

Example of numeral setting type

## 2. "System, setting file write" and "Setting file read"

It is possible to restore easily by storing setting changed program mode on the USB memory to return later.

### ■ System, setting file write

(1) Entering the function mode.

- ▶ Press  and **Function** on the Standard screen, and open the Function Mode screen.

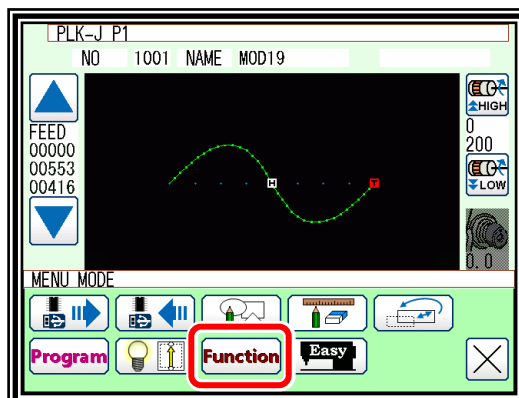

(2) Function mode screen.

- ▶ Press .

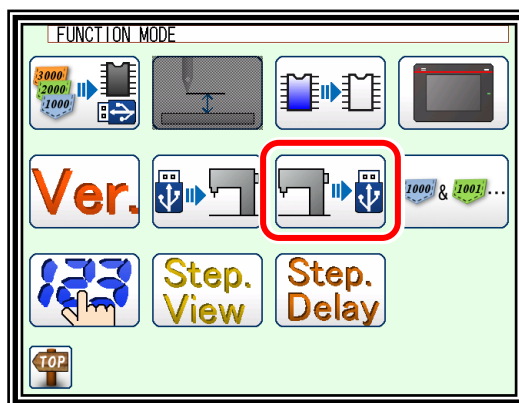

(3) Writing setting file.

- ▶ Select of  and press .

(In case of , the step file is also written continuously.)

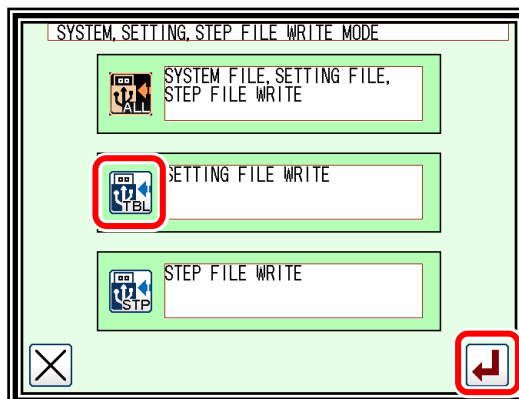

(4) Naming setting file.

- ▶ Insert the USB memory to the connector.
- ▶ Name the setting file by character buttons, then press .
- ▶ Setting file will be preserved into the [USER\_system] folder in the USB memory. Please note if the same name is exist, it is overwritten.

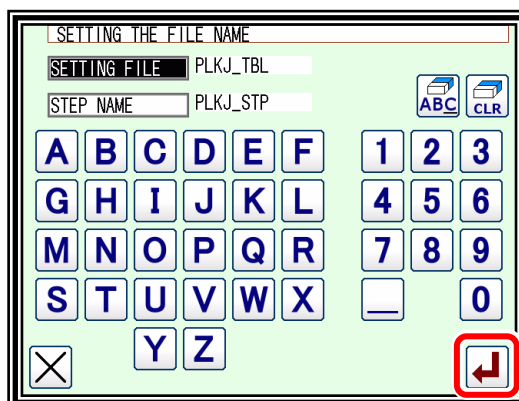

## ■ Setting file read

### (1) Entering the function mode

- ▶ Press  and **Function** on the Standard screen, and open the Function Mode screen.

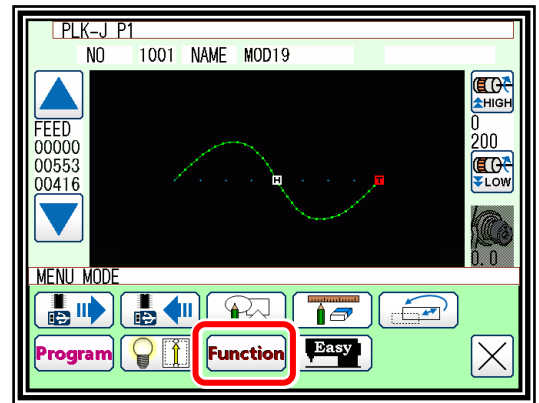

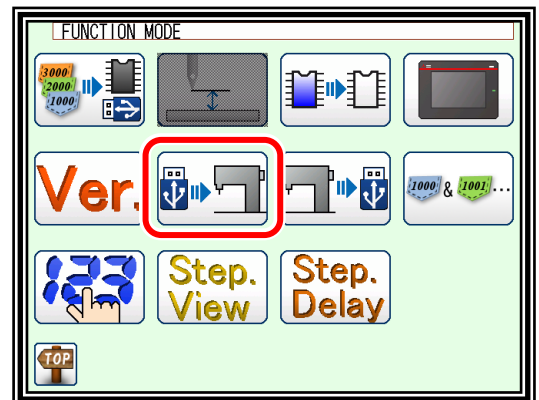

### (2) Function mode screen

- ▶ Press .



### (3) Reading setting file

- ▶ Insert USB memory where the sewing data is preserved to the connector.
- ▶ Select of  and press .
- (In case of , the step file is also written continuously.)

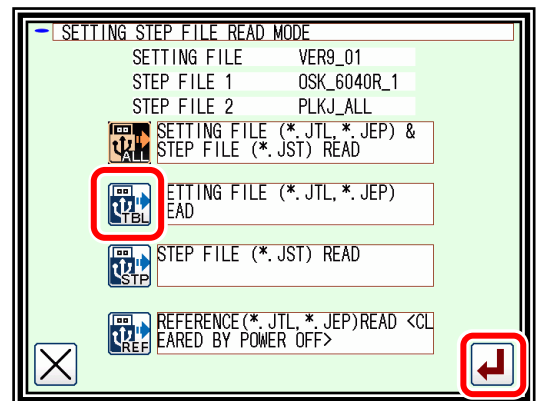

**Note** After reading the reference value, you can check the reference value from the input / output setting and program mode.

### (4) Selecting setting file

- ▶ Select setting file by using up and down arrow, then press .

**Note** Reading is proceeded by overwrite mode. Original setting data will be erased.

- ▶ When message like as [ Please turn the power supply off ] is displayed, follow the instruction.

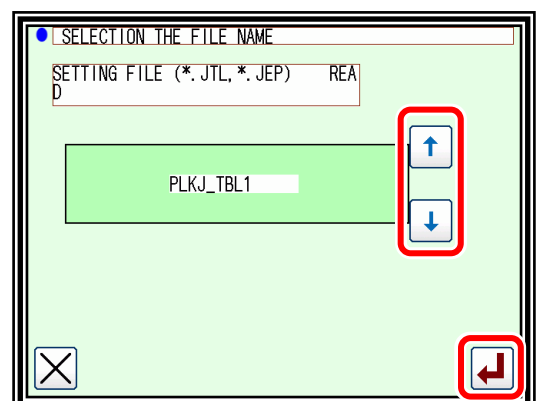

# [17] Easy Setting

## 1. Sewing setting

Main sewing related operations can be set easily.

The value of the program mode is changed to the set value.

### Operation details

#### (1) Selection of Easy setting

**Note** "Easy setting" cannot be done outside the home position. Please do "Easy setting" after home positioning.

▶ Press  on the standard screen, and open the menu mode.

▶ Press .

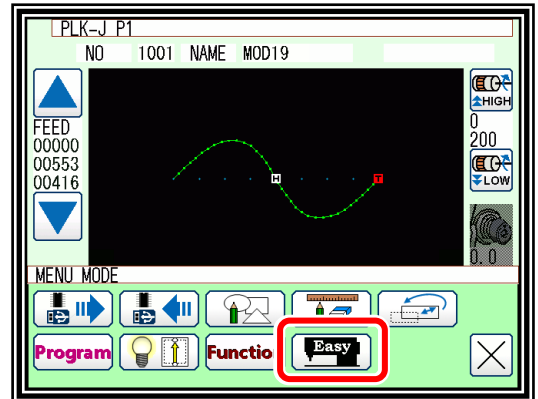

#### (2) Select Sewing setting

▶ Press .

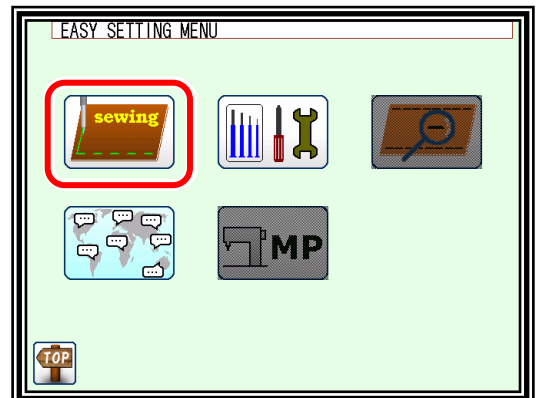

#### (3) Selection of Sewing setting

**Guide** Read the setting of the sewing guide setting data

 M3 control feed setting (X, Y)

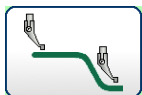
 PF motion setting

 DIGITAL TENSION motion setting

 Do not use

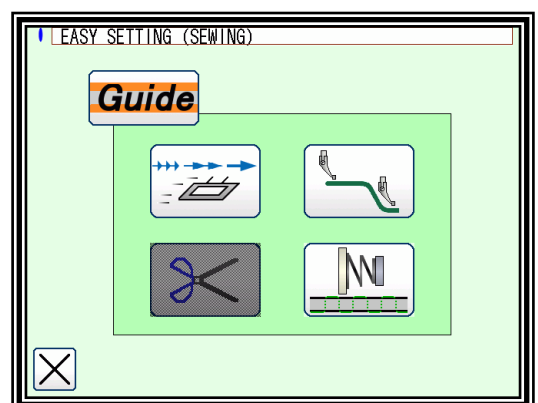

(4) Read the setting of the sewing guide setting data

By selecting the sewing guide registered in the USB, you can set it according to the cloth and use.

‡ For sewing guide data "PLKJ\_GUIDE" folder is required.

Individual folders are also required in the "PLKJ\_GUIDE" folder, so please note that sewing guide data can not be read unless it is placed in individual folders.

(For sewing guide data, please consult your dealer)

Exsample : USB -> "PLKJ\_GUIDE" folder ———> "SHOES" folder -> sewing guide data (.JSD)  
 -> "BAG" foler -> sewing guide data (.JSD)  
 -> "CAR" folder -> sewing guide data (.JSD)  
 -> "JEANS" folder -> sewing guide data (.JSD)

▶ Insert the USB memory.

▶ Press .

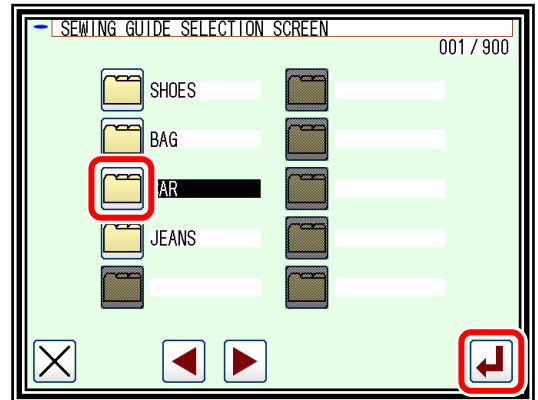

▶ Folder screen to read the sewing guide will be displayed.

▶ Select a folder and press .



**Note** A message will be displayed if USB memory is not inserted.

▶ Screen of the sewing guide will be displayed.

▶ Press   to select the sewing guide data to set.

▶ Press .

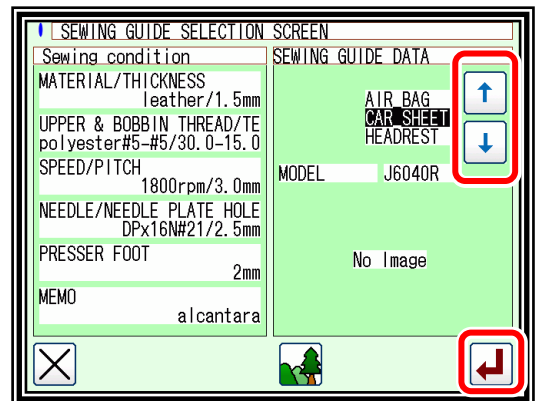

▶ As the message screen is displayed, please operate according to the screen.

▶ The setting data is reflected.

**Note** If there is an image of the sewing guide data, press  to display the image.



(5) M3 control feed setting (X, Y)

M3 control Feed setting can be changed altogether, and the feeding method can be set more finely and easily. Changed values will be reflected in the "Feed angle" of the program mode. However, feed motion / feed timing will be calculated automatically.

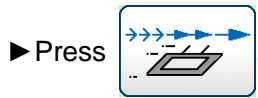

① feed motion / feed timing

- ▶ feed motion (Minimum number of revolutions of X and Y axes of M3 control feed.)

You can change [ M3 control feed speed ] by pressing



Mighty : Approach intermittent operation.

Mild : Approach to continuous motion.

- ▶ feed timing (Angle from upper needle position)

You can change [ M3 control feed angle ] by pressing 

Fast : The angle from the upper position of the needle is the front.  
(The movement start position becomes faster.)

Late : The angle from the top position of the needle will be later.  
(The movement start position is delayed.)

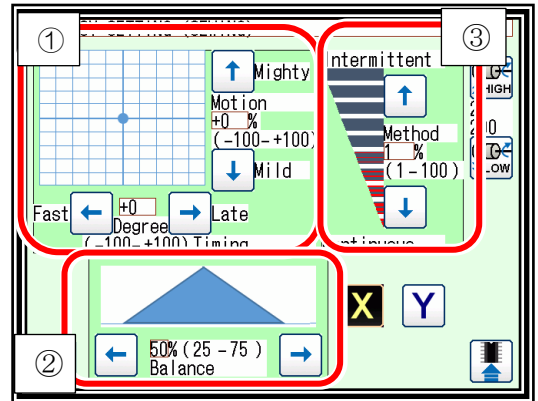

② Feed balance.(Arrangement of maximum rotation speed.)

- ▶ You can change [Slope of M3 control feed ] by pressing 

③ feed speed.

- ▶ You can change [Width of feed motion cycle (①)] by pressing 

As it approaches 100% it becomes intermittent feed (Deceleration becomes smaller) and as it approaches 0% it becomes continuous feed (The motion becomes smooth). initial value : 1%

 **Caution** As it approaches 100%, it suddenly stops and suddenly moves, so please refrain from operations other than low speed.

- ▶ Press the  to save the setting value.

- ▶ When you press  , the X axis. Press the  to switch to the Y axis.  
(The X and Y axes can be set separately)

## (6) PF motion setting

You can easily set ON / OFF with PF bottom keep motion.  
The changed value is reflected in the presser foot of program mode.



► Switch the presser foot  ON /  OFF.

When ZVRB is ON

► Press the  ZSTK  ZRWR  ZDE8  ZUS8 to change the setting value.

ZSTK : Changing up and down amount of the presser foot.

ZPWR : Changing of the PF holding power.

ZDE8 : Changing the angle which end point for PF going down.

ZUS8 : Changing the angle which start point for PF going up.

► Press the  to save the setting value.

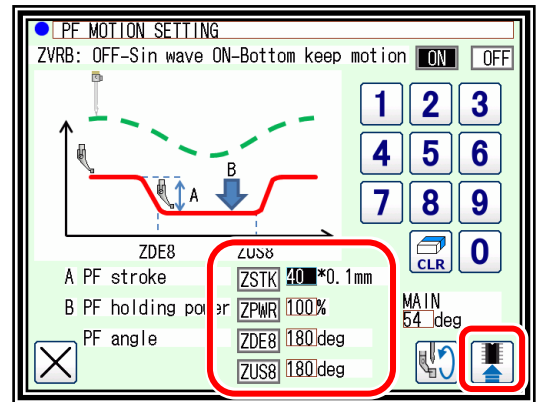

When ZVRB is OFF

► Press the  ZSTK  ZTMG to change the setting value.

ZSTK : Changing up and down amount of the presser foot.

ZTMG : Changing the phase when lowering the presser foot.

► Press the  to save the setting value.

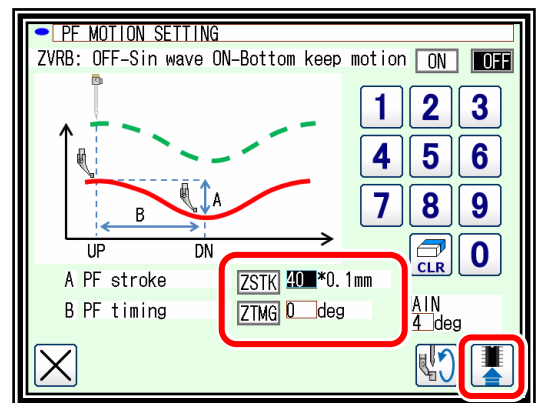



## Needle and presser foot test run

Confirm the presser foot action that was set at "PF motion setting".

►  the needle and the presser foot interlock and perform the test operation.

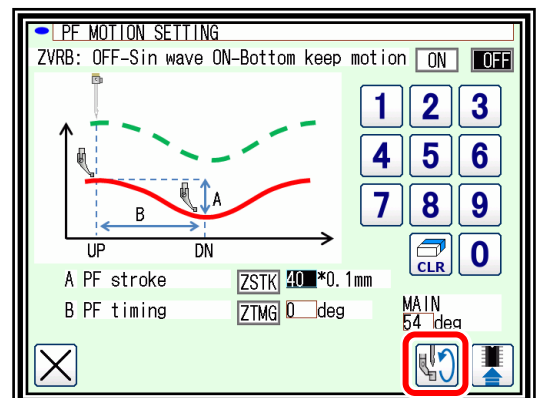
You can change rotation speed for needle and presser foot test run (MSZS) and the number of stitches (MSZN) from "presser foot" in program mode.



 **Caution** During the test operation of the needle and presser foot, even if halted halfway, the operation will continue to the upper position of the needle bar. Synchronization of the motor becomes impossible and there is a possibility that the needle and the hook may interfere, so please never turn off the power during operation.

(7) DIGITAL TENSION AT motion setting

You can set the digital tension value in 8 directions along the sewing direction.  
 When sewing in between 8 directions, it is automatically sewn with the interpolated tension.  
 The changed value is reflected in the program mode digital tension

**Note** program mode digital tension DTSN : Valid only for "AT"



▶ Press **DTA0** to **DTA7** to set the ratio of digital tension values in each direction. (rang: 10 to 300%)

**Note** **DTA0** to **DTA7** are based on the digital tension value displayed at the center.

▶ Press  to save the setting value.

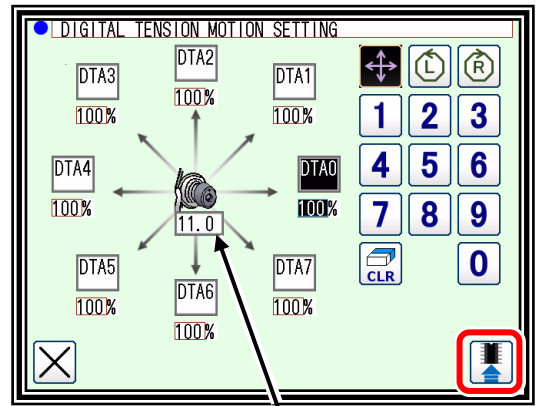

Digital tension value

An example: digital tension value = 30.5

When DTA0 = 130%, DAT0 value :  $30.5 \times (130\%) = 39.65 \rightarrow 39.5(\text{display})$

When DTA0 = 32%, DTA0 value :  $30.5 \times (32\%) = 9.76 \rightarrow 9.5(\text{display})$

‡ The digital tension gauge will be displayed in 0.5 increments.

Also, because the digital tension gauge is MAX 100, over 100 will be 100.0.

**Note** The setting screen can be switched.

Display in counterclockwise direction

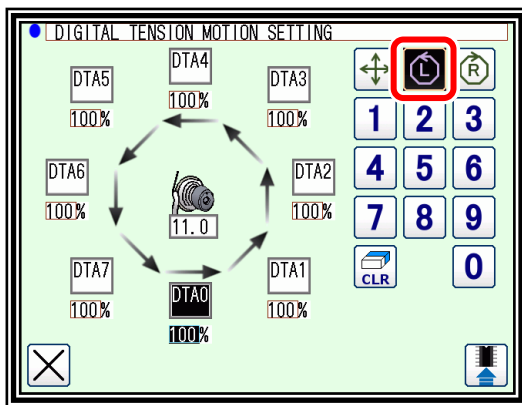

Clockwise display

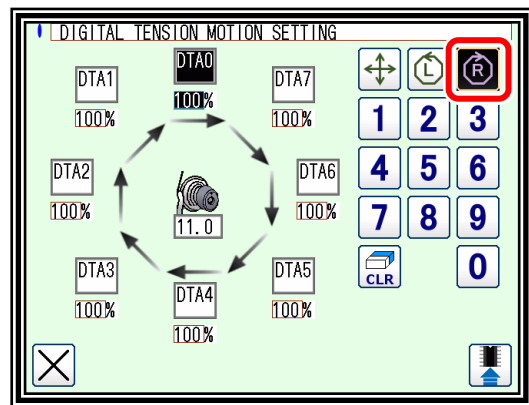

Setting the digital tension value (AT, ME mode)

1. When handling the digital tension dial, the digital tension gauge flashes.
2. Adjust to the digital tension value to be set.
3. Touch the digital tension gauge.
4. It is completed when the blinking disappears.

**Note** program mode - digital tension - You can also set the digital tension value from DTPP(pulse).

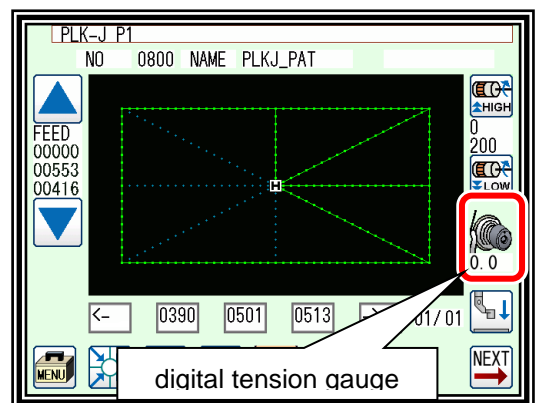

digital tension gauge

## 2. Language setting

Just by selecting the language, you can switch.

### Operation details

#### (1) Selection of Easy setting

▶ Press  on the standard screen, and open the menu mode

▶ Press .

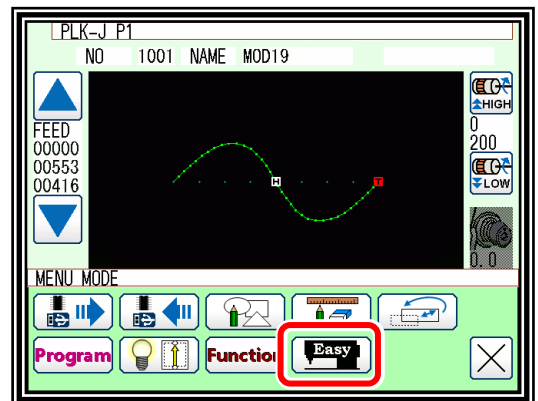

#### (2) Select Language setting

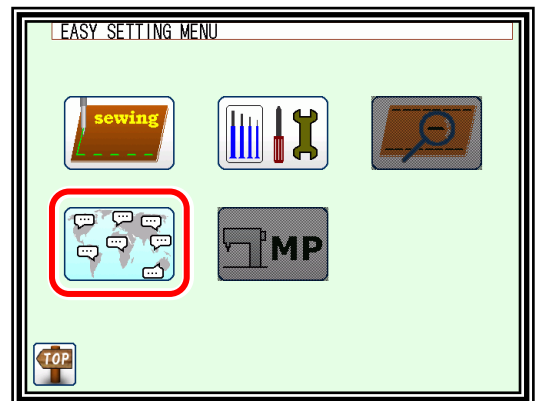

▶ Press .



#### (3) Select language

▶ Select the language to set.  
 is displayed when language is selected.

▶ Press .

When a message is displayed, if you want to change it, press . If you do not want to change it, please press . (After a while the language switches.)

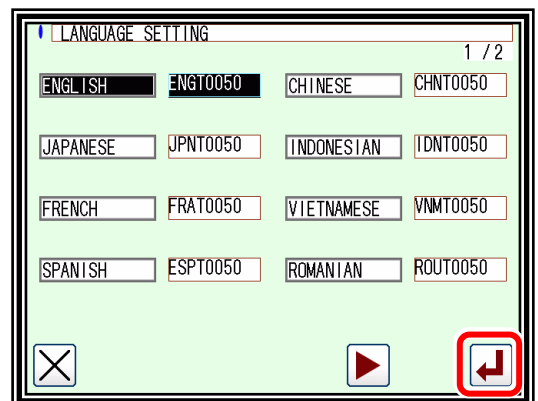

### 3. AXIS ADJUSTMENT

Since it can be done by PAL operation, it is easy to adjust the hook timing adjustment, the PF rising position adjust, thread trimming adjustment, XY home position adjustment, digital tension adjustment without removing it.

However, there are items that can not be set depending on the sewing machine you are using.

#### Operation details

(1) Select easy setting

**Note** "Easy setting" cannot be done outside the home position. Please return to the home position before setting the language.

▶ Press  from the standard screen to open the menu.

▶ Press .

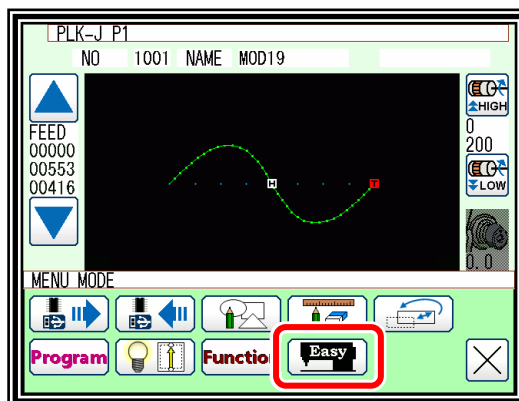

(2) Select adjustment setting.

▶ Press .

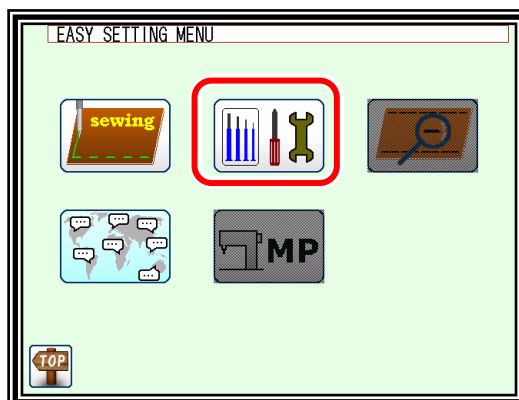

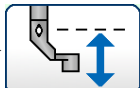

(3) Select adjustment items.

▶  Hook timing adjustment.

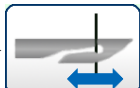
▶  PF rising position adjustment.

▶  thread trimming standby position adjustment

▶  Digital tension zero position adjustment.

▶  XY home position adjustment.

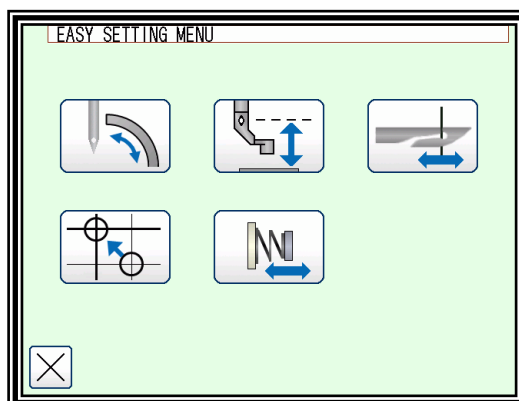

(4) Hook timing adjustment.



**Note** Only the sewing machine whose hook is independently driven by the motor can be adjusted.

- ▶ Turn the pulley of the main unit and adjust so that the timing marks of the needle bar metal and the needle bar match. (Check with the real thing)

**Note** Please pay attention to the direction of pulley rotation.

- ▶ After adjustment, press  .

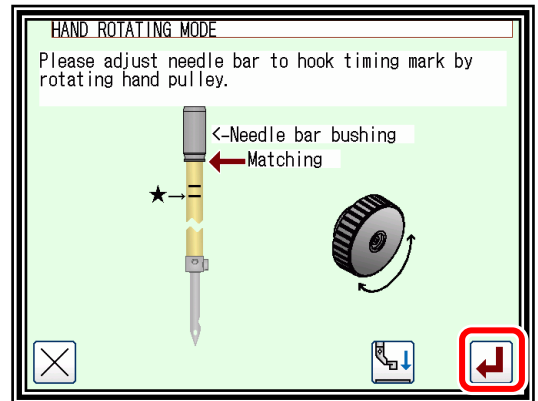

Rotary large hook type

- ▶ press   to adjust the hook angle.

(Adjust to the point where the center of the needle coincides with the hook destination)

- ▶ After adjustment, press  to save the correction value.

- ▶ After saving, exit hook adjustment screen with .

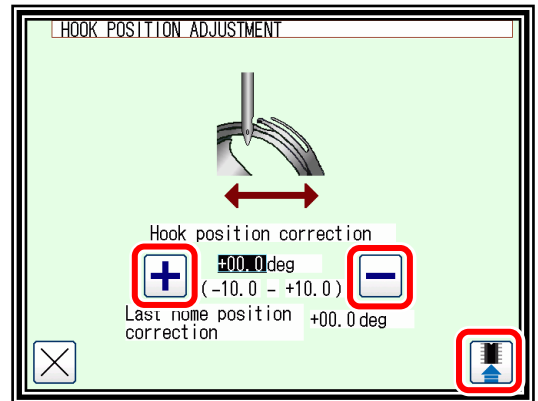

**Note** Please pay attention to the needle position. For details, refer to the separate sheet "Technical data Sewing head".

Shuttle large hook type

- ▶ Please adjust as above, same as Rotary large hook type.

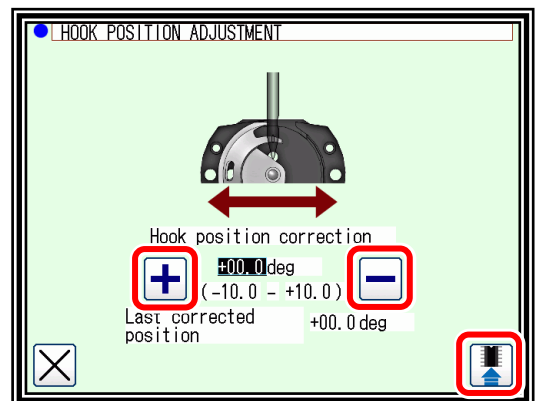

(5) PF rising position adjustment.

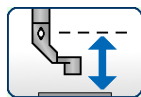

- ▶ Press   to adjust the home position of PF.

- ▶ After adjustment, press  to save the correction value.

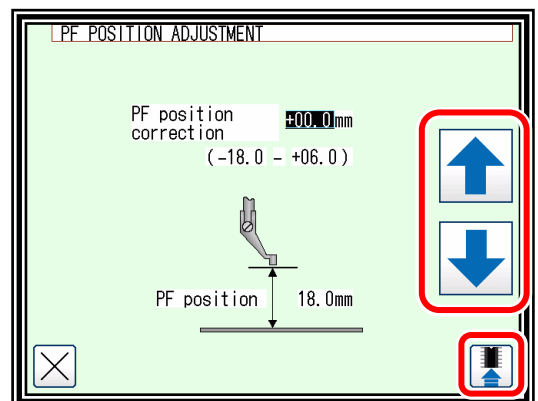

(6) thread trimming standby position adjustment

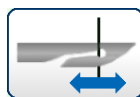

the thread trimming mechanism

Only the sewing machine whose the thread trimming mechanism is independently driven by the motor can be adjusted.

Rotary large hook type

▶ Press to adjust the origin position of the thread trimming knife.

▶ By pressing , you can operate the thread trimming knife.

Please check thread trimming before saving.

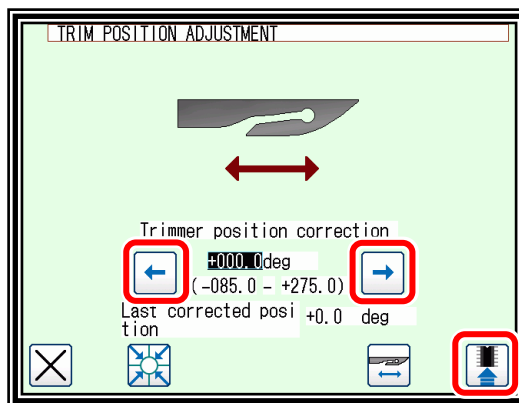

▶ After adjustment, press to save the correction value.

Shuttle large hook type

▶ Please adjust as above, same as Rotary large hook type.

**Note** Press A to return to the original value.

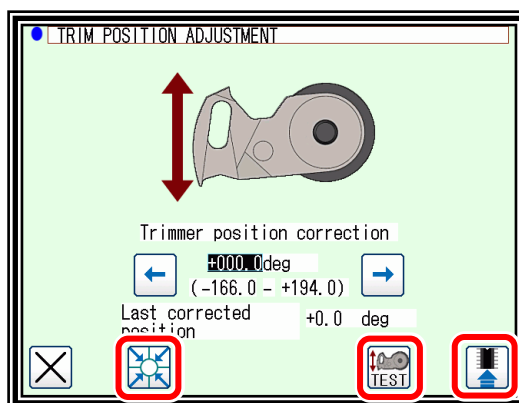

(7) Digital tension zero position adjustment.



▶ press to adjust the zero position of the digital tension.

▶ After adjustment, press to save the correction value.

**Note** Press A to return to the original value.

▶ Press to enter manual mode.

Here it is used to check the tension of the digital tension. Turn the digital tension manually to determine the position. (Correction values are not saved.)

▶ If you want to quit, you can return to the previous screen by pressing .

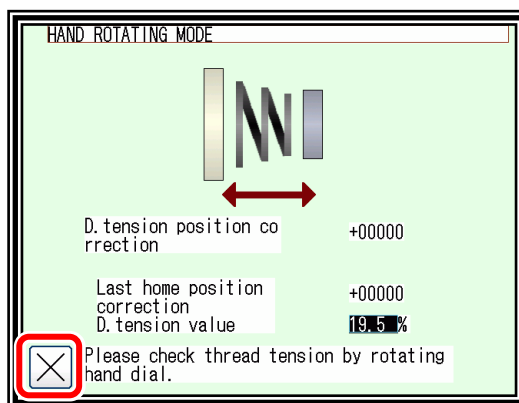
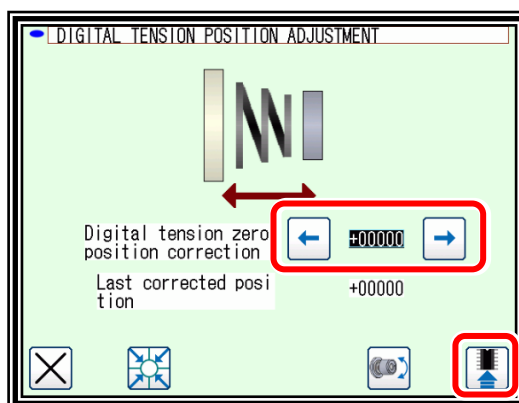

(8) XY home position adjustment.

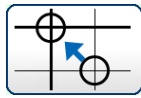

- ▶ Please step on the foot pedal and lower the presser foot.
- ▶ Please press the arrow to adjust the XY home position
- ▶ After adjustment, press  to save the correction value.

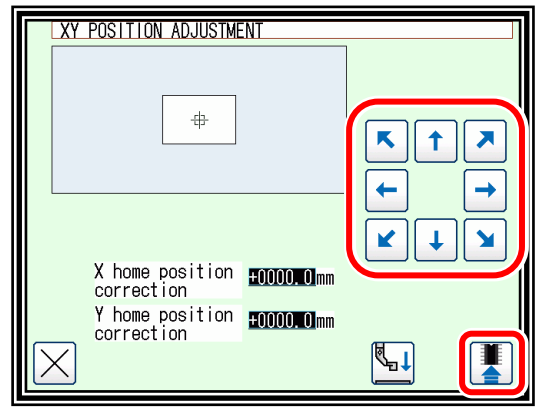

**Note** ‡ When combined data of combinations are used, make the origin correction of the setting table to be the same.

**Note** Area limit

The area size that can be used narrows when the home position is corrected. Please change the area size by the area limit so as not to knock against the frame. [XL],[XR],[YU],[YD] are provided in [Area limit] of the program mode.

**Setting example**

Area size : 600mm x 400mm

Correction value : X : +10mm, Y : -10mm

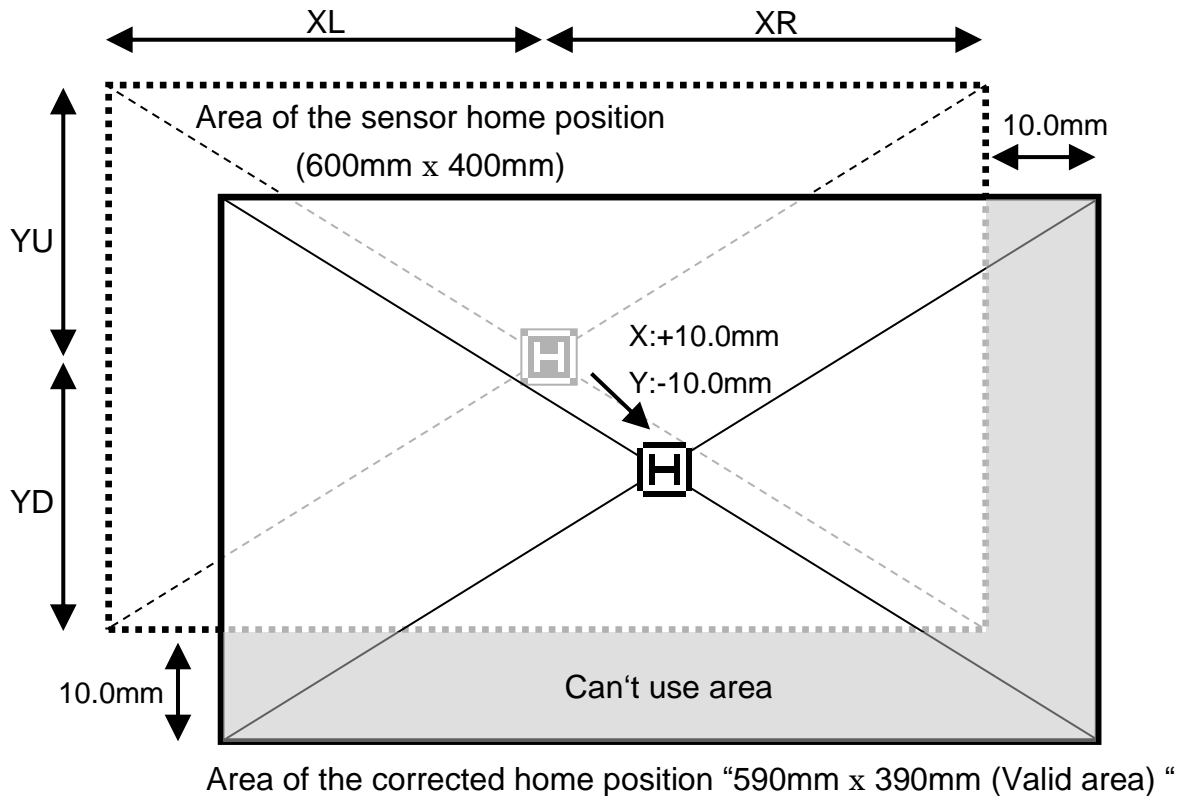

Setting change of area limit (x 0.1mm)

	Default value	Change value
[XL]	3000	3000
[XR]	3000	<b>2900</b>
[YU]	2000	2000
[YD]	2000	<b>1900</b>



# [18] System change

When it will reinstall the system for upgrade etc., please reinstall by according the following way by using USB flash drive. It is necessary [PLKJ\_SYSTEM] folder in the USB flash drive for installing. Please check the following folder in the USB flash drive.

USB flash device

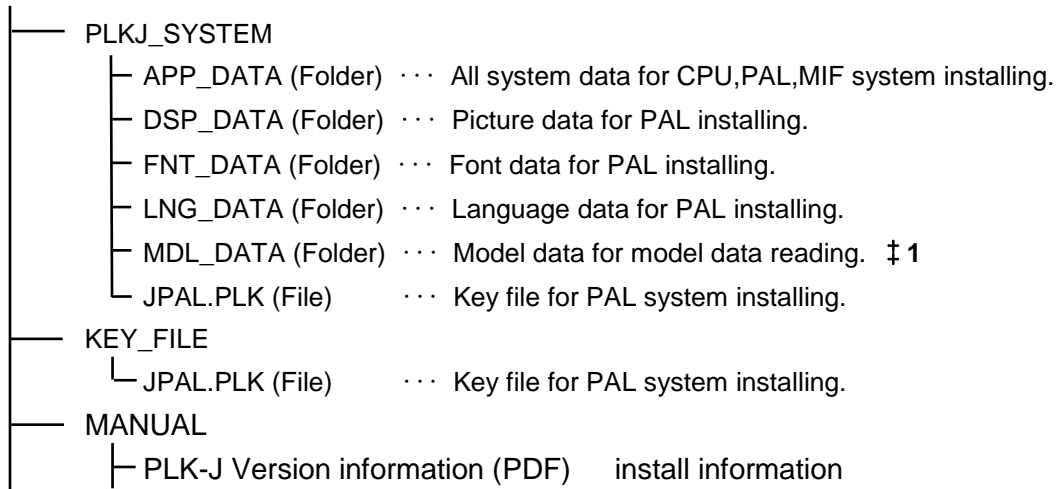

Device and installation place

Device	Install contents	USB flash drive connection	Operation
Control box	System data · MAIN SYSTEM · DRIVE SYSTEM · FPGA MAIN · FPGA MIF	CON W (PAL)	Install button + Turn ON
	Model data "Setting of sewing machine for each model"		Install button + Turn ON ‡ 2
PAL	System data · LCD SYSTEM	CON W (PAL)	Key file ‡ 1+ Turn ON
	Display data · LANGUAGE · LCD PICTURE · LCD FONT	CON W (PAL)	Touch the Mitsubishi logo after Turn ON
I/F board (MIF)	System data · MIF SYSTEM · FPGA MIF	CON U (MIF)	Turn ON

‡ 1 The "JPAL.PLK" key file will be deleted from the "PLKJ\_SYSTEM" folder as the installation is completed, so copy it from the "KEY\_FILE" folder and use it.

‡ 2 You can also initialize the sewing machine's settings without using USB flash drive. Refer to page [11] – 6 "5.initialize settings".

# 1. Control box install

## ① CPU system upgrade

(1) Please insert USB flash drive to CON W connector on the operation panel.

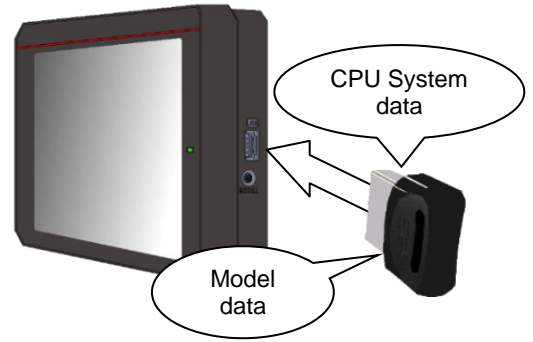

(2) Please hold down the install button and turn on the power.

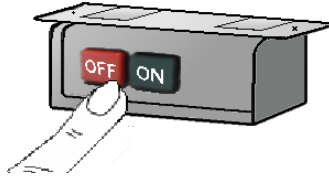

Please press install button for about 5 seconds from power on

+

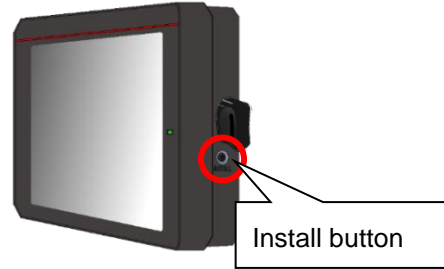

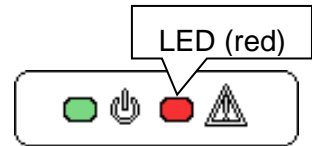

(3) It will start to install, please wait a while still complete installing.

The red LED on the front of the control panel will be displayed during installation.



‡ If the red LED flashes, the installation has failed, Check the "PLKJ\_SYSTEM" folder inside the USB flash drive and try again.

(4) After the installation is completed, the "model set initialize function" screen will be displayed. If "SELECT", select model data from USB.

► Please select the model name by   key.  
And it is decided by push the  key.

‡ Since it becomes the initial value, please refrain from the setting data when necessary.

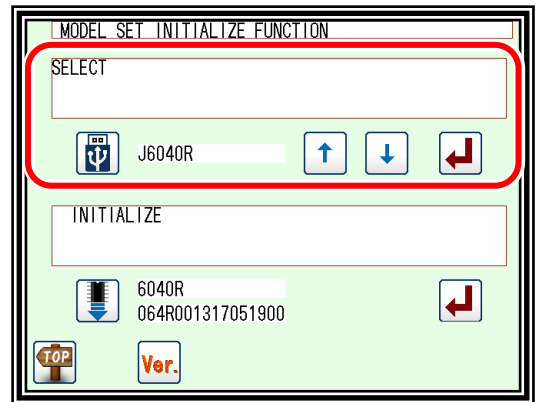

► Message is displayed.

Please turn off the power according to the message.

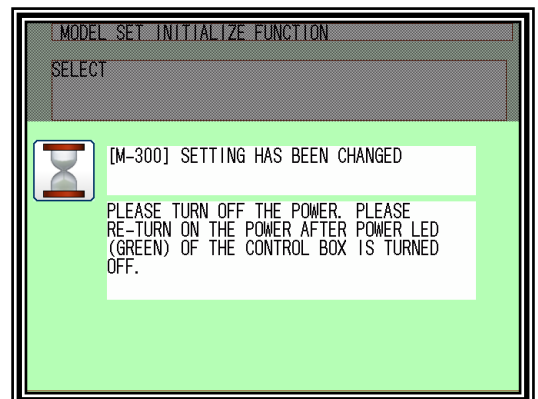

## 2. PAL install

### ① PAL system upgrade

(1) Please put the key file [JPAL.PLK] into "PLKJ\_SYSTEM" folder in USB flash drive.

**Note** ‡ If there is not the key file in "PLKJ\_SYSTEM" folder, it is impossible to upgrade.

**Notice** ‡ The "JPAL.PLK" key file will be deleted as the installation is completed. To install again please copy from the "KEY FILE" folder and use it.

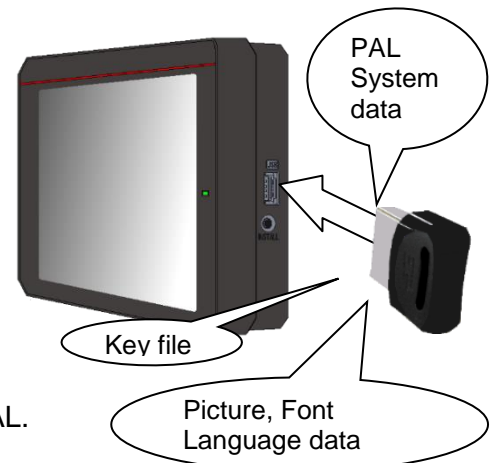

(2) Please insert USB flash drive to CON W connector on PAL.

(3) Turn the power on.

- ▶ The buzzer sounds eight times.  
(If the buzzer does not sound, it will not install.  
Please check the key file.)
- ▶ Startup screen will appear after a while.

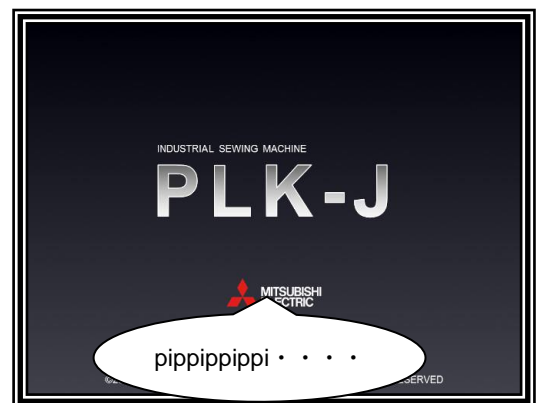

(4) Installing complete.

- ▶ Display is switched to standard screen after installing complete.

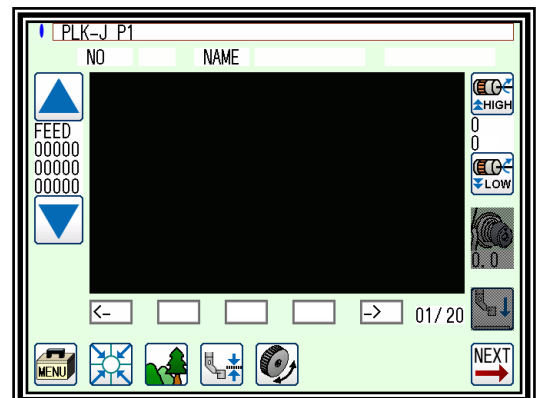

### ② Upgrade for Picture, Font, Language data

(1) Please insert USB flash drive to CON W connector on PAL.

(2) Turn the power on.

- ▶ Please touch the Mitsubishi logo on the screen soon after display the startup screen.

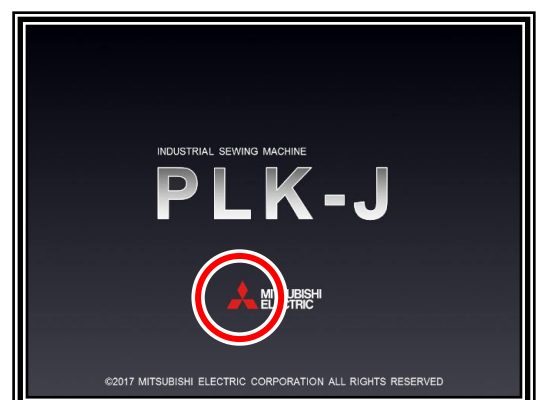

- ▶ It is appeared the install bar after sounds buzzer.

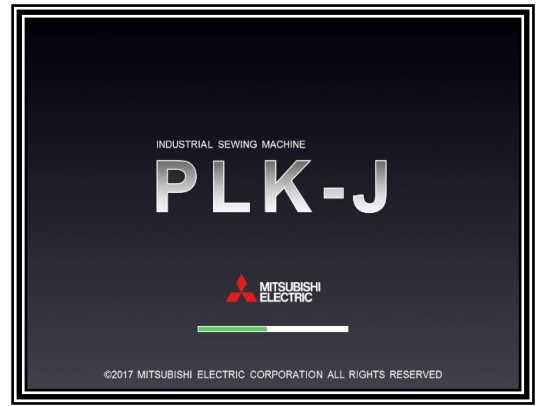

- ▶ In the case of a Successful installation, the install bar will turn blue.

**Note** If the red LED is blinking, the installation has failed. Check the "PLKJ\_SYSTEM" folder inside the USB flash drive and try again.

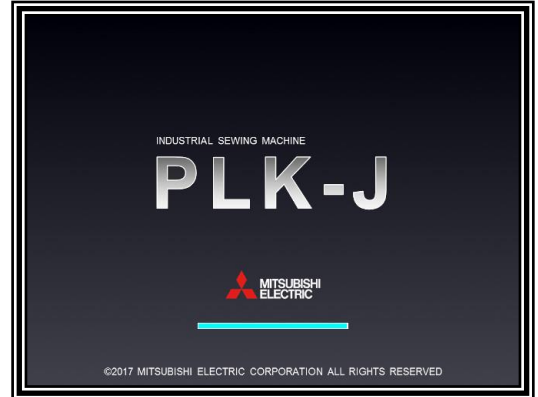

### (3) Installing complete

- ▶ The install bar change blue bar from green bar after installing complete.
- ▶ Display is switched to standard screen after installing complete.

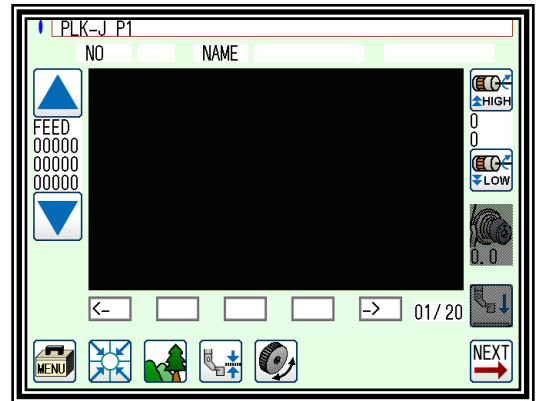

## 3. I/F board (MIF) Install

### MIF system upgrade

- (1) Please insert USB flash drive to CON U connector on I/F board.

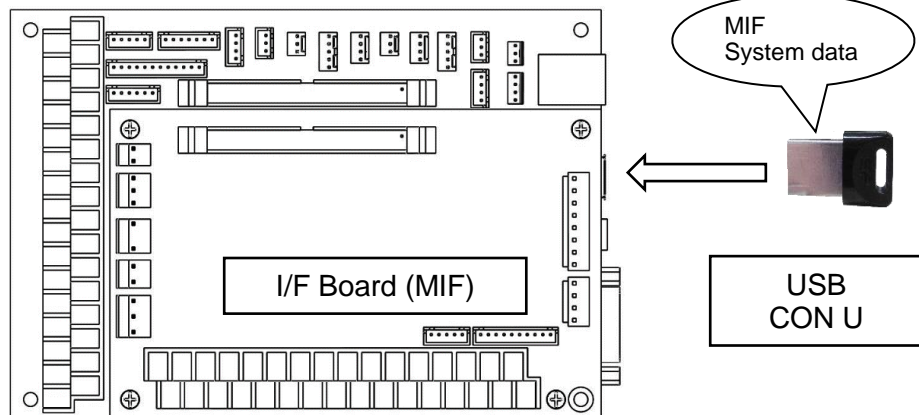

- (2) Turn the power on.

- ▶ It is started to install automatically, please wait a while at the startup screen.
- ▶ When the display is switched to standard screen, it become installing complete.

## 4. Confirm version information

Make sure the installed version is correct.

- (1) Select function from PAL menu

▶ Press  to **Function**.

▶ Press  to display the version display function screen.

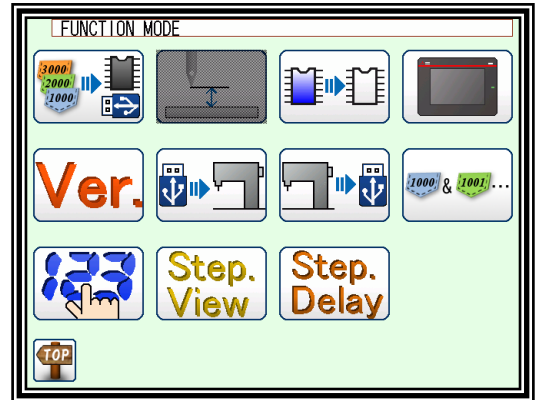

- (2) Confirmation by check function

Insert the USB flash drive containing the "PLKJ\_SYSTEM" folder used for installation. Compare the file in the USB flash drive with the software version inside the sewing machine.

▶ Press  to check the version.

If the version is different, it will be displayed in reverse.

‡ When USB is unconnected and pushes the  button, it is made all reversing display.

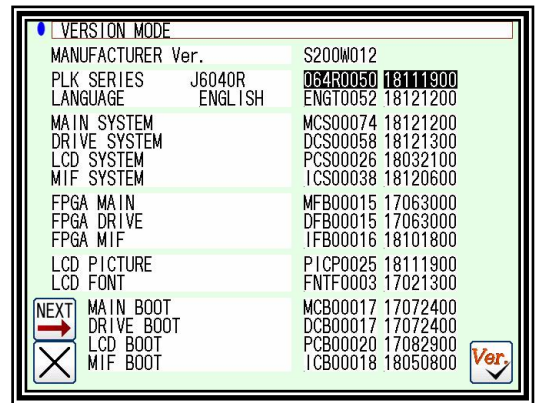

- (3) Check with the **PLK-J Version information (PDF)** in the USB memory against the version display screen.

‡ PLK-J Version information (PDF) contains the software version at the time of shipment.

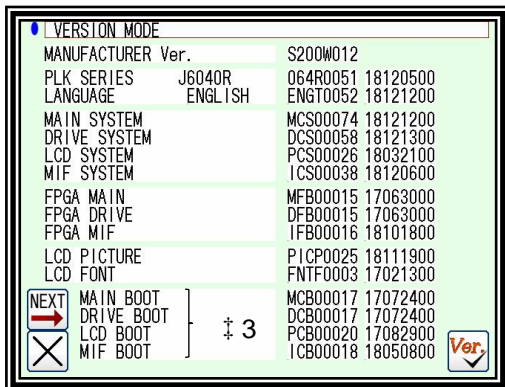

PAL screen

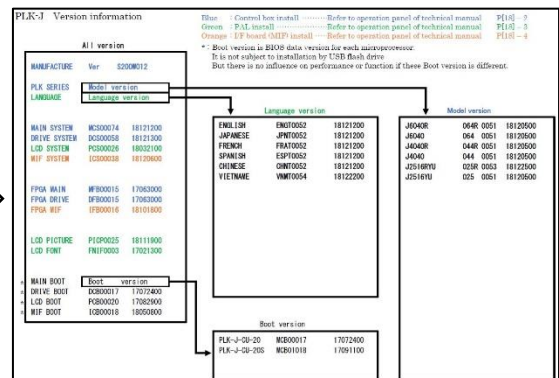

PLK-J Version information

- (4) If there is a part that does not match the software version, please re-install the part.

Please refer to the table of P[18] -1 for the location updated by installation.

‡ 3: Boot version is BIOS data version for each microprocessor.

It is not subject to installation by USB flash drive

But there is no influence on performance or function if these Boot version is different.

## 5. Initialize settings

You can initialize the sewing machine settings without using USB flash drive.

Please hold down the install button and turn on the power.

Reset the setting of the sewing machine you are using to "Initialize" to the initial value.

"Initial setting value in internal memory"

- ▶ It decide by  key
- ▶ A message will be displayed, so please operate according to the message.

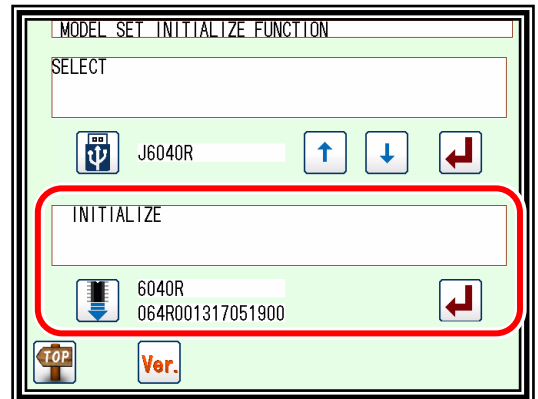

**Note** When returning to the standard screen without changing the initial value

When you press the  key, a message like the one on the right appears.

If you touch  key, it is possible to move standard screen without initialize.

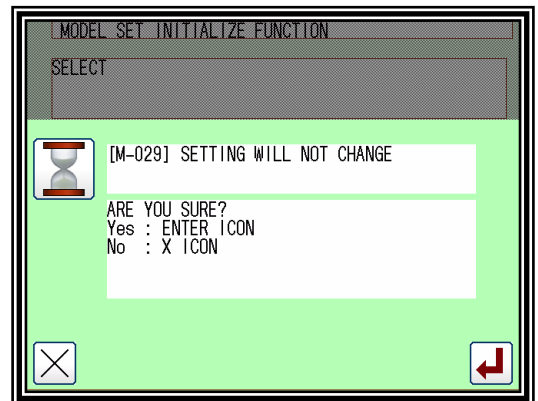

**Note** To erase internal memory, please use format.  
Refer to the technical document for operation panel page [14] - 3 "Format".

# [19] FF-stitch

## 1. Outline

What is FF-stitch ?

With FF - stitch, you can adjust the sewing seams actually sewn as follows without changing the pattern data.

- When jumping out at corner stitch

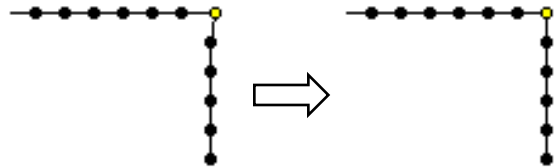

- When the return stitch are not arrange

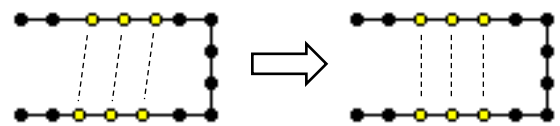

- When sewing start, sewing end stitch are not arrange

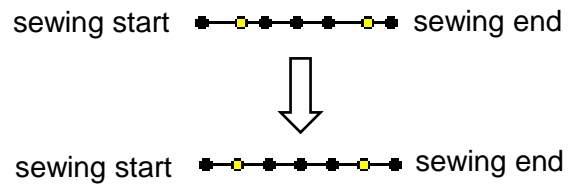

Adjustment is done on standard screen 3.

‡ For compatible models, please contact your dealer.

What is a needle drop point ?

The needle drop point is where the needle sticks into the cloth.

A needle drop point is an important element in forming a stitch, and when the needle drop point changes, the appearance of the stitch changes. With FF - stitch, you can adjust this needle drop point and fine - tune the stitch. (Refer to the figure below)



figure : Adjustment of needle drop points

Adjustable needle drop point

Adjustable range is fixed. Please refer to the table below.

● : Adjustable needle drop point,

↔ : Movement direction of needle drop point

	icon	name	X direction	Y direction	Remarks
Adjustment of corner		Sewing direction is right rotation, "upper right and lower left corner"			sewing direction ‡ When there is a change of direction more than 45 degrees with respect to the sewing direction, it is recognized as a corner. (Refer to the figure below) 
		Sewing direction is right rotation, "upper left and lower right corner"			
		Sewing direction is left rotation, "upper right and lower left corner"			
		Sewing direction is left rotation, "upper left and lower right corner"			
Adjustment of return		round trip X direction		—	S : sewing start E : sewing end ‡ It is possible to adjust needle drop points other than sewing start and sewing end.
		round trip Y direction	—		
Adjustment of sewing start or sewing end		X direction of sewing start		—	S : sewing start E : sewing end
		X direction of sewing end		—	
		Y direction of sewing start	—		S : sewing start E : sewing end
		Y direction of sewing end	—		



## 2. Explanations of Standard screen 3

Displays the Standard screen 3 from the Standard screen 2, by pressing .  
 "Compatible models only"

The Standard screen 2 is explained in detail below.

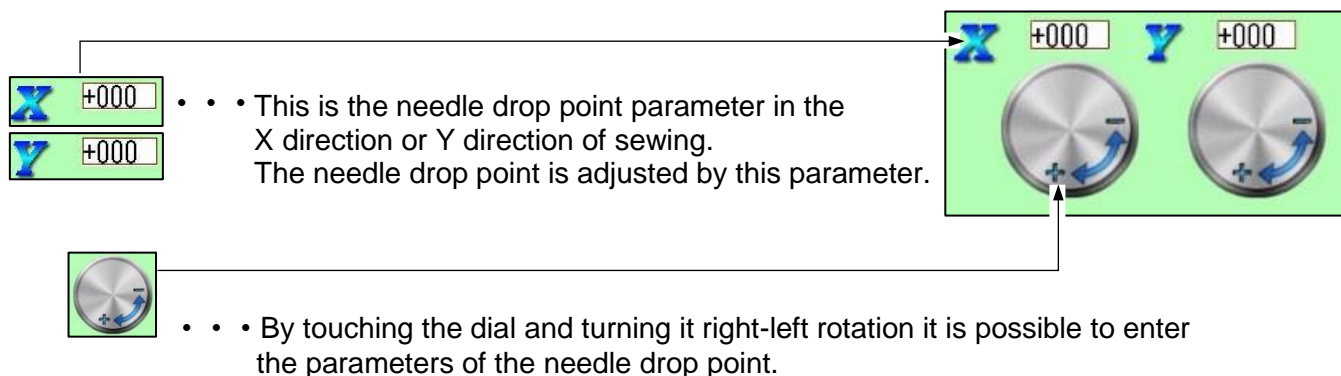
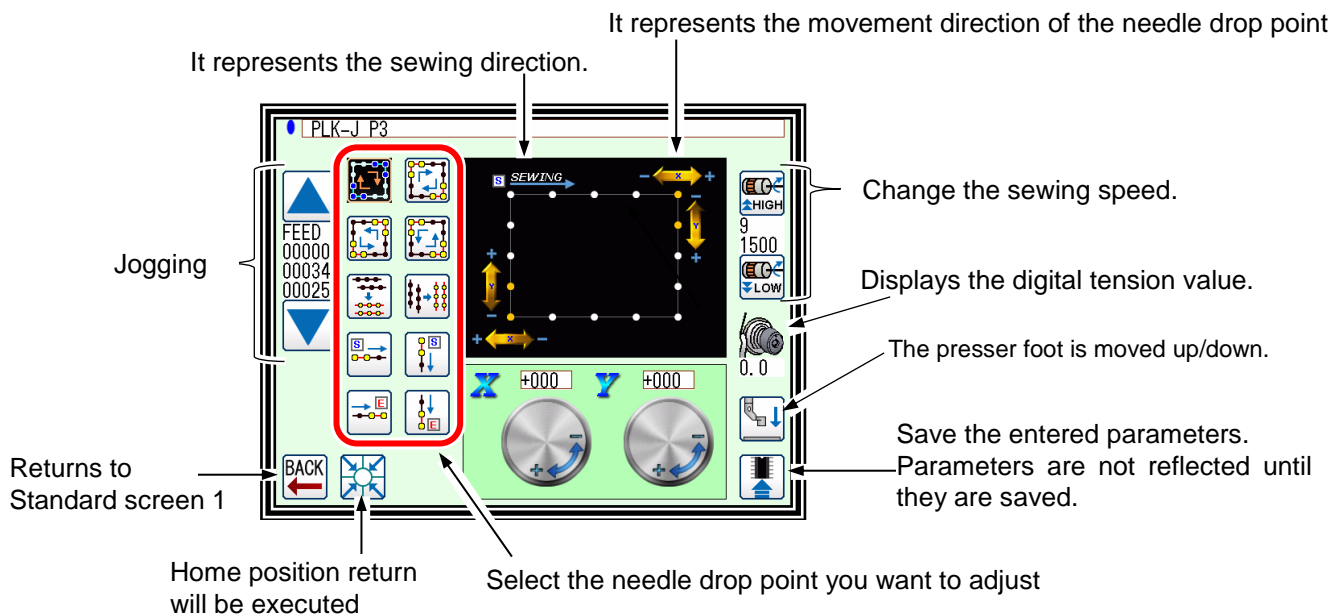

By turning it right rotation you can enter plus, turn it left rotation to input minus.  
**To adjust in the stitch direction as the sewing direction, enter plus.**  
**To adjust in the direction reverse to the sewing direction, enter a minus.**

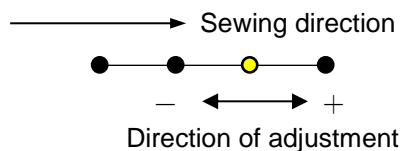

### 3. Operation explanation

Adjust with standard screen 3 pressing  from standard screen 2.

(1) When needle drop point (①,②) at the corner of the figure below is adjusted to needle drop point (①',②')

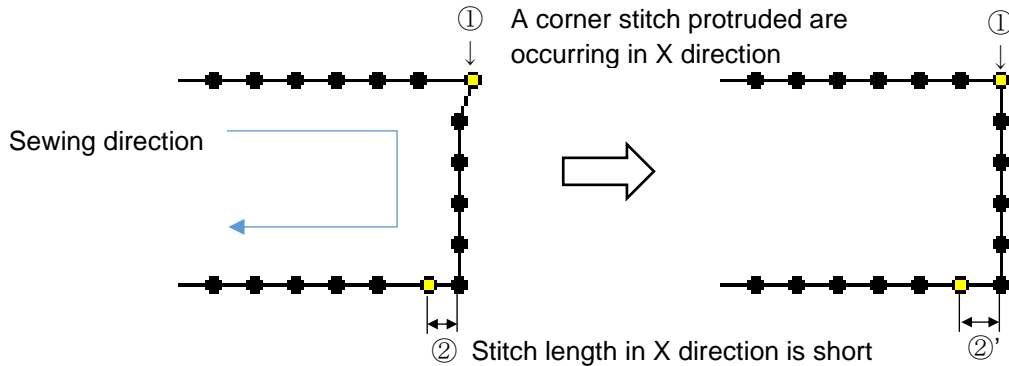

#### ① Adjustment when corner stitch protruded in X direction

▶ Select the type of needle drop point to be adjusted.

Please press .

▶ Turn X on Dial  in the minus direction.

▶ Press  to save the set value.

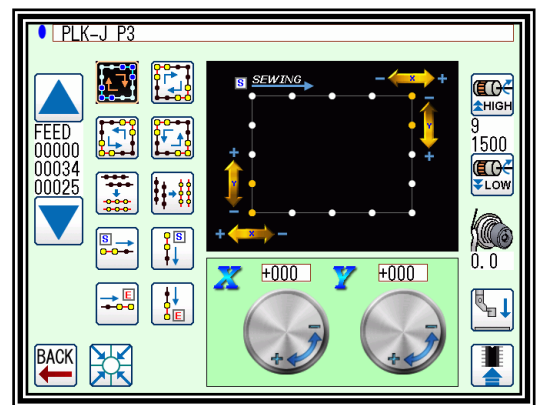



#### ② Adjustment when the stitch length in X direction is short

▶ Select the type of needle drop point to be adjusted. Please press .

▶ Turn X on Dial  in the plus direction.

▶ Press  to save the set value.

**Note** If you press  without saving the setting value, the setting will be canceled.

**Note** After pressing , you can sewing on this screen and check the stitch

(2) When needle drop point (③,④) at the corner of the figure below is adjusted to needle drop point (③',④') "The stitch direction is reverse direction to the above statement"

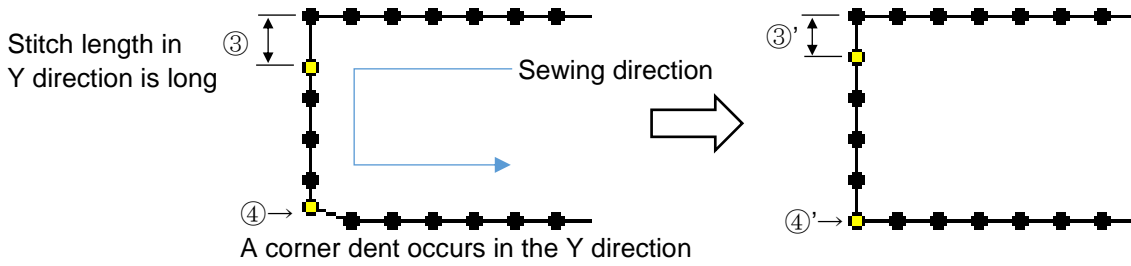

③ Adjustment when the stitch length in Y direction is long

▶ Select the type of needle drop point to be adjusted.

Please press

▶ Turn Y on Dial in the minus direction.

▶ Press to save the set value.

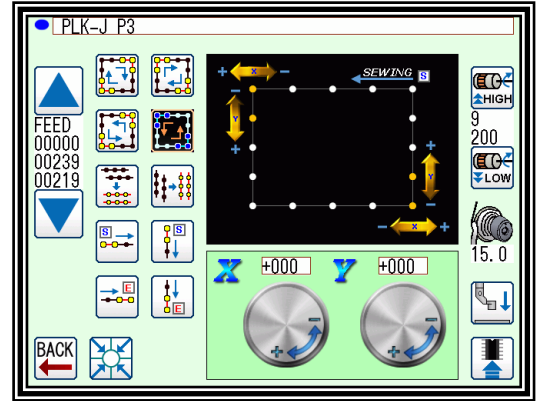

④ Adjustment when corner dent occurs in the Y direction

▶ Select the type of needle drop point to be adjusted. Please press

▶ Turn Y on Dial in the plus direction.

▶ Press to save the set value.

(3) When needle drop point (⑤) at the corner of the figure below is adjusted to needle drop point (⑤')

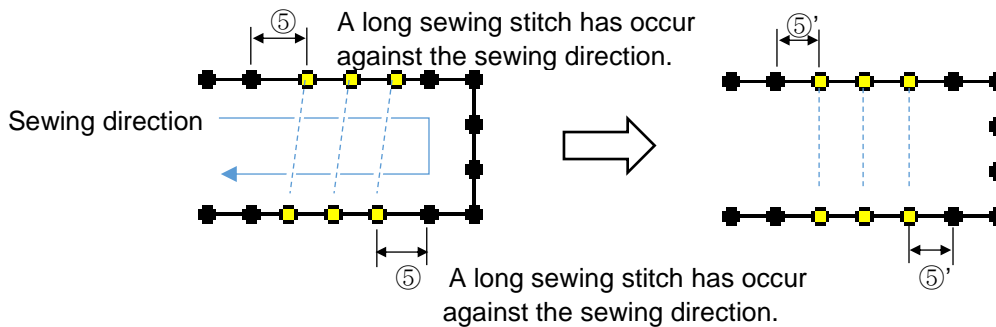

⑤ Adjustment when A long sewing stitch has occur against the sewing direction. (To Align round trip stitch)

▶ Select the type of needle drop point to be adjusted.

To adjust the X direction, please press

▶ Turn X on Dial in the minus direction.

▶ Press to save the set value.

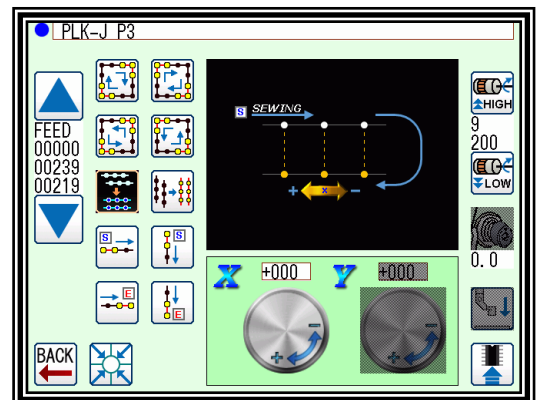

(4) When needle drop point (⑥) at the corner of the figure below is adjusted to needle drop point (⑥')

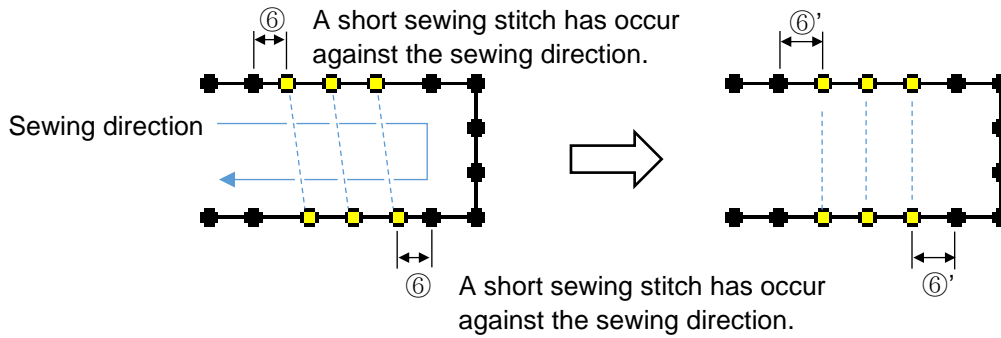

⑥ Adjustment when A short sewing stitch has occur against the sewing direction. (To Align round trip stitch)

▶ Select the type of needle drop point to be adjusted.

To adjust the X direction, please press

▶ Turn X on Dial in the plus direction.

▶ Press to save the set value.

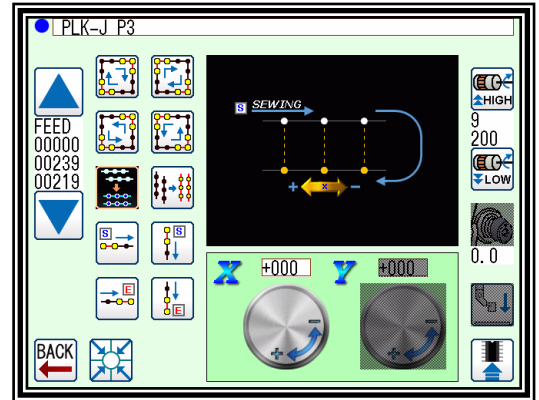

(5) When needle drop point (⑦) at the corner of the figure below is adjusted to needle drop point (⑦')

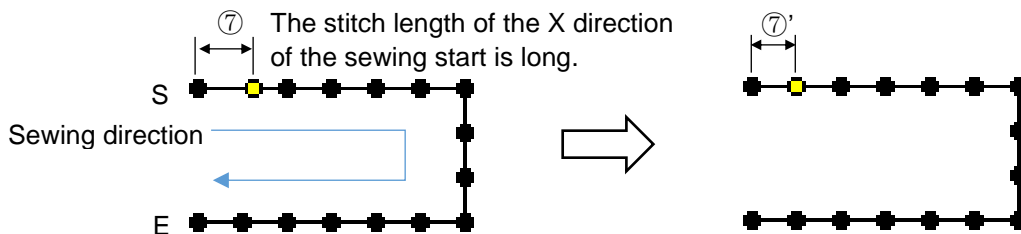

⑦ Adjustment when the stitch length of the X direction of the sewing start is long.

▶ Select the type of needle drop point to be adjusted.

To adjust the X direction, please press

▶ Turn X on Dial in the minus direction.

▶ Press to save the set value.

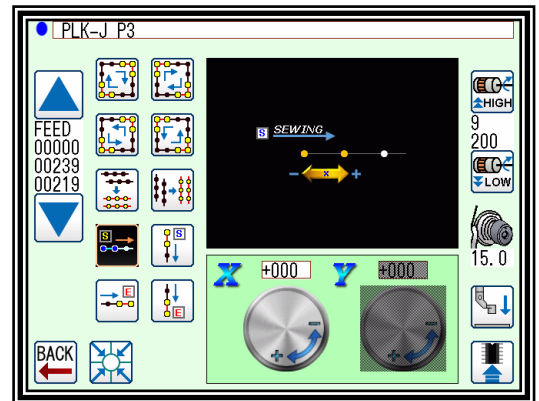

The short sewing stitch against sewing direction is occurring

(6) When needle drop point (⊗) at the corner of the figure below is adjusted to needle drop point (⊗')

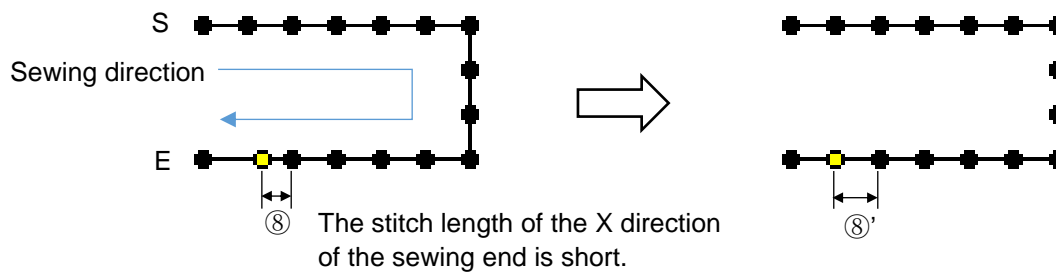

⊗ Adjustment when the stitch length of the X direction of the sewing end is short.

▶ Select the type of needle drop point to be adjusted.

To adjust the X direction, please press 

▶ Turn X on Dial  in the plus direction.

▶ Press  to save the set value.

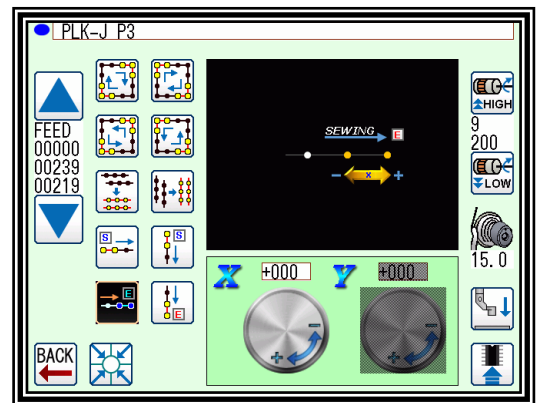

 **Caution** Extreme adjustment may cause needle breakage and damage to the fabric.  
An example : 0 → +20, +20 → -20  
It is recommended that adjustment be made little by little and confirmed.

**Note** The position of the adjustable needle drop point in the figure described in the operation panel and technical data is an example. Depending on the sewing machine model and setting, it may be around several stitches.

**Note** When driving at low speed such as slow start, FF - stitch can be ignored according to the speed. Refer to program-mode Page [20] - 23 "23. Traceability"

**Note** The setting value of FF-stitch is saved in the setting data, not saved in the pattern data. Setting data can be written to back up the setting value of FF - stitch to USB memory.

**Note** The needle drop point changes in finish depending on conditions such as speed, needle thickness, fabric thickness etc. Please test whenever sewing conditions change.

## [20] Program mode list

### 1. Wiper

Function	Unit	Setting range	Specification
WIP	Valid/invalid of the wiper output is switched.		
Wiper ON/OFF	-	OF	The wiper is invalidated.
		ON	The wiper is validated.
W1	ms	0 to 998	The output start time of the wiper output (W) can be set. Please set referring to thread trimming timing chart.
Wiper output (W) start time (based on needle up position)			
W2	ms	0 to 998	The output time of the wiper output (W) can be set. Please set referring to thread trimming timing chart.
Wiper output (W) start time			

### 2. Slow start

Function	Unit	Setting range	Specification
SL	Valid/invalid of the slow start is set.		
Slow start ON/OFF	-	OF	The slow start is invalidated.
		ON	The slow start is validated. Slow start will be applied to the start of all stitching (when power is turned ON, during HALT, and during jogging operation, etc.).
SLN	Sti	0 to 5	Number of stitches of the first sewing speed (slow start) can be set.
No. of slow start stitches			
S	rpm	100 to LOW	The speed (slow start) of the first sewing can be set.
SLS	Sets effective/ineffective for super-slow start.		
Super slow start ON/OFF	-	OF	Super slow start is set ineffective.
		ON	Super slow start is set effective. When (SL) setting is set effective, the first stitch will start by super-slow speed.
SLP	rpm	25 to 100	Sets super slow start speed.

### 3. Clamp

Function	Unit	Setting range	Specification
RPT	The repeat sewing operation is set.		
Repeat sewing ON/OFF	-	OF	The normal stitching operation is entered. (Repeat sewing RP1-RP4 is invalidated.)
		ON	The repeat sewing RP1-RP4 is validated.
RP1	RP1: The repeat sewing operation is set.		
Repeat sewing 1	-	OF	The normal stitching operation is entered. (Repeat sewing RP1 is invalidated.)
		ON	The repeat sewing RP1 is validated. (valid when RPT = [ON] )
RP2	RP2: The repeat sewing operation is set.		
Repeat sewing 2	-	OF	The normal stitching operation is entered. (Repeat sewing RP2 is invalidated.)
		ON	The repeat sewing RP2 is validated. (valid when RPT = [ON] )

< Continuation of [ Clamp ] >

Function	Unit	Setting range	Specification
RP3 Repeat sewing 3	RP3: The repeat sewing operation is set.		
	-	OF	The normal stitching operation is entered. (Repeat sewing RP3 is invalidated.)
	-	ON	The repeat sewing RP3 is validated. (valid when RPT = [ON] )
RP4 Repeat sewing 4	RP4: The repeat sewing operation is set.		
	-	OF	The normal stitching operation is entered. (Repeat sewing RP4 is invalidated.)
	-	ON	The repeat sewing RP4 is validated. (valid when RPT = [ON] )
WHY Priority of clamp mode	Sets the priority of clamp.		
	-	OF	The movement setting of clamp 1 - clamp 4 can be randomly set.
	-	ON	The movement of clamp 1 - clamp 4 will be in the order of clamp 1 - clamp 4.
FSR All cancel at over-step movement	The method of the clamp up for the step clamp movement is set.		
	-	OF	After all of the clamps have been lowered [ON], the clamps are not raised [OFF] regardless the clamp step input signal is turned [ON].
	-	ON	After all of the step clamps have been lowered [ON], when the clamp step input signal is turned [ON] once, all of the clamps are raised [OFF].
1PD Valid or invalid 1 pedal action	Sets the pedal specification (1 pedal/2 pedals).		
	-	OF	The normal operation (two pedals) is effective.
	-	ON	1 pedal action is valid. When start switch is pressed, clamp is lowered and sewing is started automatically.
1T Start delay setting for 1 pedal action	ms	0 to 5000	Waiting time between clamp down and start sewing is set.
1A Clamp 1 of output on delay setting	ms	0 to 10000	Sets the time (TA1) from the clamp input 1 ON to clamp output 1 ON.
2A Clamp 2 of output on delay setting	ms	0 to 10000	Sets the time (TA2) from the clamp input 2 ON to clamp output 2 ON.
3A Clamp 3 of output on delay setting	ms	0 to 10000	Sets the time (TA3) from the clamp input 3 ON to clamp output 3 ON.
4A Clamp 4 of output on delay setting	ms	0 to 10000	Sets the time (TA4) from the clamp input 4 ON to clamp output 4 ON.
1B Clamp 1 of output off delay setting	ms	0 to 10000	Sets the time (TB1) from the clamp input 1 ON to clamp output 1 OFF.
2B Clamp 2 of output off delay setting	ms	0 to 10000	Sets the time (TB2) from the clamp input 2 ON to clamp output 2 OFF.
3B Clamp 3 of output off delay setting	ms	0 to 10000	Sets the time (TB3) from the clamp input 3 ON to clamp output 3 OFF.
4B Clamp 4 of output off delay setting	ms	0 to 10000	Sets the time (TB4) from the clamp input 4 ON to clamp output 4 OFF.

< Continuation of [ Clamp ] >

Function	Unit	Setting range	Specification
OFB The divisions of clamp blocks	4 clamps can be bundled to blocks.		
	-	NO	Use 4 clamp types in 1 block (OF1-OF4). The following functions become valid: [Setting of valid clamp (FN.)] and [Setting of clamp link (CF)].
		2	DO NOT USE.
		4	Use 4 clamp types in 2 blocks (OF1, OF2), (OF3, OF4). The following functions become valid: [No. of valid clamp blocks setting (F2BN)].
FN Setting for valid number of clamp	-	1 to 4	[Divisions of clamp (OFB.)] is validated when set to [NO]. Number of outputs (clamp) from [PR1 (OF1)] to [PR4 (OF4)] can be set. Sewing is possible when all selected number of outputs (clamp) are [ON].
CF Clamp synchronize ON/OFF setting	The [The divisions of clamp (OFB.)] is validated when set to [NO].		
	-	OF	The clamps are not synchronized.
		ON	The clamps are synchronized. (For details, see the timing chart.)
F2BN Setting for number of valid clamp blocks	-	1 to 2	Setting is effective when OFB = [4]. Following blocks are used depends on the setting. 1:Block1, 2:Block1+2, (Block1 = OF1+OF2, Block2 = OF3+OF4,)
F2SN Setting for number of block when block step is used	-	1 to 2	When set the OFB = [4], the clamp blocks of this value executes step movement. 1:Block1, 2:Block1+2, (Block1 = OF1, OF2 Block2 = OF3).
AF2 Selection of pneumatic pressure two-step clamp	The pneumatic presser two-step clamp is set.		
	-	OF	Use the normal clamp.
		ON	Use the pneumatic pressure two-step clamp (Option). In this case, all of the specifications of the other clamps are invalidated.
OPR Prohibition of sewing data reading when clamp is raised	Reading the sewing data is prohibited by the state of the clamp.		
	-	OF	Sewing data can be read regardless of the state of clamp.
		ON	Sewing data read is prohibited when the clamp is raised.
OST Prohibition of operation (sewing, JOG) when clamp is raised	Prohibition of operation (sewing, JOG) when clamp is raised		
	-	OF	Operation (sewing, JOG) is prohibited when clamp is raised.
		ON	Starts even if the clamp is not down position.
CHK Cassette jig function ON/OFF	Change the cassette jig function effect.		
	-	OF	Cassette jig function is invalid.
		ON	Cassette jig function is valid.
CSN ON/OFF of auto chucking of cassette jig sensor	Change the cassette jig sensor effect.		
	-	OF	Auto chucking of cassette jig sensor is invalid.
		ON	Auto chucking of cassette jig sensor is valid.
CSY Cassette jig sensor ON/OFF during sewing	Change the cassette jig sensor effect. (During sewing)		
	-	OF	It is possible to start sewing without the cassette jig sensor is detected.
		ON	It is possible to start sewing after the cassette jig sensor is detected.



## 4. Area limit



**CAUTION** When the value of the sewing area limit is changed or the limit setting is deactivated, note the collision and take care safely.  
Also when using it outside the range where the mechanism can be operated, it can not assume the responsibility for all problems caused by it.

Function	Unit	Setting range	Specification
ALC Area limit cancel ON/OFF	Change the sewing area limit effect.		
	-	OF	The stitching area limit is validated. (XL, XR, YU, YD setting is reflected)
	-	ON	The stitching area limit is invalidated. (The stitching area limit is canceled.) Please use this setting with attention.
XL [X axis left side] area limit setting	x0.1 mm	1 to 65535	The numerical value of the X motor left side area limit can be setting in the software. The default setting for the X motor left side area limit differs according to the model. Do not reduce this value much. Error occurs.
XR [X axis right side] area limit setting	x0.1 mm	1 to 65535	The numerical value of the X motor right side area limit can be setting in the software. The default setting for the X motor right side area limit differs according to the model. Do not reduce this value much. Error occurs.
YU [Y axis rear side] area limit setting	x0.1 mm	1 to 65535	The numerical value of the Y motor rear side area limit can be setting in the software. The default setting for the Y motor rear side area limit differs according to the model. Do not reduce this value much. Error occurs.
YD [Y axis front side] area limit setting	x0.1 mm	1 to 65535	The numerical value of the Y motor front side area limit can be setting in the software. The default setting for the Y motor front side area limit differs according to the model. Do not reduce this value much. Error occurs.

## 5. Needle position

Function	Unit	Setting range	Specification
RU Reverse needle lifting operation after thread trimming function	Sets reverse needle lifting operation after thread trimming function.		
	-	OF	The reverse needle lifting after thread trimming is invalidated.
	-	ON	The reverse needle lifting operation after thread trimming is validated. Reverse angle is set by [R8] setting.
D8 Setting for needle DOWN position coasting angle	deg.	0 to 85	The main and sub motor coasting angle from down position.
U8 Setting for needle UP position coasting angle	deg.	0 to 85	The main and sub motor coasting angle from up position. (The angle from Main motor up position to the thread take-up lever at the highest position)
R8 Setting for reverse angle of needle lifting operation	deg.	0 to 85	The main and sub motor coasting angle from up position when reverse needle lifting operation (RU) after thread trimming function is ON. (The angle from the thread take-up lever at the highest position to the needle bar at the highest position)
NUS ON/OFF of sewing prohibition when needle is not up position	Sets ON/OFF of start sewing when needle is not up position.		
	-	OF	When needle is not up position, needle is moved to up position automatically and sewing is started.
	-	ON	When needle is not up position, sewing is not started.

## 6. Thread breaking sensor

Function	Unit	Setting range	Specification
S1 Needle thread breaking sensor ON/OFF	Sets Valid/invalid of the needle thread breaking sensor.		
	-	OF	The needle thread breaking sensor is ineffective.
		ON	The needle thread breaking sensor is effective.
S2 The number of ignore stitches at the beginning of sewing.	Sti	0 to 15	The number of ignore stitches at the beginning of sewing is set.
S3 Invalid stitches of the stitch in progress sensor	Sti	0 to 99	Sets the number of valid stitches which is detected by thread breaking sensor.
B Rotation speed to disregard thread breaking sensor	rpm	LOW to HIGH	Rotation speed to disregard thread breaking sensor can be set. When the machine rotate below this setting, thread breaking sensor becomes invalid. Set value of rotation speed in consideration of speed variation.
TST ON/OFF of thread trimming at needle thread breaking detection.	Valid/invalid of the thread trimming is switched, when the needle thread breaking sensor is detected.		
	-	OF	The thread trimming when the needle thread breaking sensor detection is invalidated.
		ON	The thread trimming when the needle thread breaking sensor detection is validated.

## 7. Home position

Function	Unit	Setting range	Specification
HPM Home return method after HALT	Home return method after HALT position is set.		
	-	--	Home return is executed when the home reset icon is turned ON.
		JS	When the home reset icon is turned ON at the HALT position, the machine will automatically be moved like as JOG [-] icon operation.
		JE	When the home reset icon is turned ON at the HALT position, the machine will automatically be moved like as JOG [+] icon operation.
		JC	When the home reset icon is turned ON at the HALT position, home returning will automatically be executed. If the position is at the [center] or [in the first half], the machine return to home like as [JS]. If the position is [in the latter half], the machine return to home like as [JE].
HPF Prohibition of automatic home returning when clamp is raised	Sets prohibition of home returning when the clamp is raised.		
	-	OF	Home return is executed regardless of state of the clamp.
		ON	Home returning is prohibited when the clamp is raised.
HPK Home return icon setting	The home returning icon operation is selected.		
	-	--	The home return operation is executed when the home reset icon is turned ON once.
		2	The home returning operation is executed when the home reset icon is turned ON twice in succession. If the home reset icon is turned ON only once, the home returning operation will not be executed.
		2L	DO NOT USE.
		NO	The home returning operation by the home reset icon is prohibited.

< Continuation of [ Home position ] >

Function	Unit	Setting range	Specification
2HS Stop method at second home position	Action at a time when the machine reads second home position is selected.		
	-	ST	When the machine reads second home position, machine is stopped.
		SW	When the machine reads second home position, machine is stopped and clamp goes up.
		NS	The sewing machine does not stop on the second home position.
HPS The home returning operation when the clamp rises at power on.	Sets the home returning operation when the clamp rises at power on.		
	-	OF	Home returning operation is executed regardless of clamp state at power on.
		ON	Home returning operation is prohibited when the clamp is up at power on.
NNU Home positioning prohibition when needle is not the UP position	Home return prohibition when needle is not the UP position.		
	-	OF	When needle is deviated from the up position, it is automatically moved to up position and home positioning is executed.
		ON	Home return is disabled when needle is not the UP position.
SHP Home returning method since the second time returning	Sets home returning method since the second time returning.		
	-	OF	Does not use home returning sensor for XY stepping motor.
		ON	Uses home returning sensor for XY stepping motor.
NUK ON/OFF for display of needle up and X ICON at M-001 message	Sets for display of needle up and X ICON at M-001 message, when invalid of the home positioning (NNU) function is ON and needle is not UP position. If NNU function is [OF], this function is invalid.		
	-	OF	Enable display of needle up and X ICON at M-001 message, when NNU function is ON.
		ON	Disable display of needle up and X ICON at M-001 message, when NNU function is ON.
HPL Limit value for home position supplementation.	x0.1 mm	0 to 10000	Set the limit value of supplementation from original XY axis home position.

## 8. Halt

Function	Unit	Setting range	Specification
STF Stop position setting when halt switch is pressed while non stitch feed operation	Stop position when halt switch is pressed while non stitch feed operation can be set.		
	-	CP	When the HALT switch is turned ON, non-stitching feed will be executed until the breakpoint (the position where non-stitching feed direction changes).
		ST	When the HALT switch is turned ON, the machine will stop at that position.
STN Needle position when halt switch is turned on.	Sets needle positioning when the halt switch is turned on.		
	-	DN	When the HALT switch is on, the needle will stop at the DOWN position.
		UP	When the HALT switch is on, the needle will stop at the UP position.

< Continuation of [ Halt ] >

Function	Unit	Setting range	Specification
<b>STS</b> The state of each output when the HALT switch is turned on	Selects the state of each output when the HALT switch is turned on.		
	-	AL	All outputs will be held (ON is maintained). (exclude wiper, trimmer, thread release)
		FU	Keep the output state of the clamp relation.(keep output excluding general purpose, wiper, trimmer and tension release)
		OF	Release output for the clamp relation, general purpose, wiper, trimmer, tension release.
<b>ST2</b> HALT switch two-press operation (stop at down position)	The operation for when the HALT switch is pressed twice at the needle down position can be selected. (when set (STN) = [DN])		
	-	UT	When the HALT switch is turned on again, the needle will stop at the up position after thread trimming.
		UP	When the HALT switch is turned on again, the needle will stop at the up position without thread trimming.
		ST	The needle will stay at the down position even if the HALT switch is turned ON again.
<b>STP</b> DO NOT USE	DO NOT USE.		
	-	--	DO NOT USE.
		PD	DO NOT USE.
<b>STD</b> Clamp condition during halt state by the STOP code	Sets the clamp condition during halt state by the STOP code.		
	-	FU	Clamp goes up after machine is stop.
		FD	Keeps clamp condition after machine is stop.
<b>STL</b> Prevention of two drops at the same point after HALT	After needle down position stop, restart operation can be selected.		
	-	OF	After needle down position stop, machine restarts from the stop position. (needle goes down at the same position twice.)
		ON	After needle down position stop, machine restarts from next stitch point. (needle does not go down at the stop position.)

## 9. Counter

Function	Unit	Setting range	Specification
<b>CUP</b> Function of UP counter	Sets function of UP counter		
	-	--	Up counter is not executed.
		ED	Up counter increases every 1 sewing is end.
		ST	Up counter decreases every N stitches (N is set by [CNU] setting).
		SD	Up counter increases every 1 sewing is start.
<b>CDN</b> Function of DOWN counter	Sets function of DOWN counter.		
	-	--	Down counter is not executed.
		ED	Down counter decreases every 1 sewing is end.
		ST	Down counter increases every N stitches (N is set by [CND] setting).
		SD	Down counter decreases every 1 sewing is start.
<b>CNU</b> Number of stitches of each 1 count for UP counter	sti	5 to 1000	Setting of the number of stitches when "ST" of the CUP setting is selected.

< Continuation of [ Counter ] >

Function	Unit	Setting range	Specification
<b>CND</b> Number of stitches of each 1 count for DOWN counter	sti	5 to 1000	Setting of the number of stitches when "ST" of the CDN setting is selected.
<b>UCM</b> Method of clearing UP counter setting value	Up counter clear method at the pattern data change is selected.		
	-	--	The UP counter value and current value are both not changed.
		RE	When pattern data is changed, UP counter set value is change to the number which is contained in the pattern data.
		IT	When pattern data is changed, UP counter set value is not changed and UP counter current value is set to 0.
		CL	When pattern data is changed, UP counter set value and current value is set to 0.
<b>DCM</b> Method of clearing DOWN counter setting value	Down counter clear method at the pattern data change is selected		
	-	--	The DOWN counter value and current value are both not changed.
		RE	When pattern data is changed, DOWN counter set value is change to the number which is contained in the pattern data.
		IT	When pattern data is changed, DOWN counter set value is not changed and down counter current value is changed to set value.
		CL	When pattern data is changed, DOWN counter set value and current value is set to 0.
<b>PCM</b> Valid/invalid for initialization of UP/DOWN counter value at power on.	Sets counter clear method at power supply on.		
	-	--	The counter is not initialized.
		IT	Initializes (The UP counter current value is set to 0, and the DN counter current value is set to counter setting.)
<b>CN</b> stitch number pre-check function	Selects stitch number check function at the beginning of sewing.		
	-	OF	The machine does not check next stitch number at the beginning of sewing.
		ON	The machine checks next stitch number at the beginning of sewing.
<b>UCC</b> Prohibition of UP counter current value correction	Sets prohibition of UP counter current value		
	-	OF	The current value of the UP counter can be modified.
		ON	The current value of the UP counter can not be modified.
<b>DCC</b> Prohibition of DOWN counter current value correction	Sets prohibition of DOWN counter current value		
	-	OF	The current value of the DOWN counter can be modified.
		ON	The current value of the DOWN counter can not be modified.
<b>USC</b> Restart sewing ON/OFF after count up completion	Setting for restart sewing by UP counter completion		
	-	OF	Even when the count value of the UP counter reaches the set value, the next sewing machine operation can be continued.
		ON	When the count value of the UP counter reaches the set value, the next sewing machine operation will be prohibited. When the message is cleared, sewing operation can be continued.

< Continuation of [ Counter ] >

Function	Unit	Setting range	Specification
DSC Restart sewing ON/OFF after count down completion	Setting for restart sewing by DOWN counter completion.		
	-	OF	Even when the count value of the DOWN counter reaches the set value, the next sewing machine operation can be continued.
		ON	When the count value of the DOWN counter reaches the set value, the next sewing machine operation will be prohibited. When the message is cleared, sewing operation can be continued.
CNTS Stop ON/OFF after thread trimming function when UP/DOWN counter is used	Sets the stop position when UP/DOWN counter reach the setting value.		
	-	OF	It stops immediately when UP/DOWN counter reach the setting value.
		ON	It stops after thread trimming when UP/DOWN counter reach the setting value.
CNT1 ON/OFF of user counter 1 function	Valid/Invalid user counter 1 function.		
	-	OF	Invalid user counter 1 function.
		ON	Valid user counter 1 function.
CT1U The unit of user counter 1	Set unit of the user counter 1.		
	-	ST	The unit of the user counter 1 is number of stitch.
		T	The unit of the user counter 1 is number of thread trimming.
CT1S Setting value of warning displayed user counter 1	-	1 to 9999	Sets the warning indication of user counter 1. CT1V and CT1S value are setting value.
CNT2 ON/OFF of user counter 2 function	Valid/Invalid user counter 2 function.		
	-	OF	Invalid user counter 2 function.
		ON	Valid user counter 2 function.
CT2U The unit of user counter 2	Set unit of the user counter 2.		
	-	ST	The unit of the user counter 2 is number of stitch.
		T	The unit of the user counter 2 is number of thread trimming.
CT2V The unit coefficient of user counter 2	-	1 to 65535	Sets the unit of user counter 2.
CT2S Setting value of warning displayed user counter 2	-	1 to 9999	Sets the warning indication of user counter 2. CT2V and CT2S value are setting value.
CNT3 ON/OFF of user counter 3 function	Valid/Invalid user counter 3 function.		
	-	OF	Invalid user counter 3 function.
		ON	Valid user counter 3 function.
CT3U The unit of user counter 3	Set unit of the user counter 3.		
	-	ST	The unit of the user counter 3 is number of stitch.
		T	The unit of the user counter 3 is number of thread trimming.
CT3V The unit coefficient of user counter 3	-	1 to 65535	Sets the unit of user counter 3.
CT3S Setting value of warning displayed user counter 3	-	1 to 9999	Sets the warning indication of user counter 3. CT3V and CT3S value are setting value.
CNT4 ON/OFF of user counter 4 function	Valid/Invalid user counter 4 function.		
	-	OF	Invalid user counter 4 function.
		ON	Valid user counter 4 function.

< Continuation of [ Counter ] >

Function	Unit	Setting range	Specification
CT4U The unit of user counter 4	-	ST T	Set unit of the user counter 4. The unit of the user counter 4 is number of stitch. The unit of the user counter 4 is number of thread trimming.
CT4V The unit coefficient of user counter 4	-	1 to 65535	Sets the unit of user counter 4.
CT4S Setting value of warning displayed user counter 4	-	1 to 9999	Sets the warning indication of user counter 4. CT4V and CT4S value are setting value.

## 10. Presser foot

Function	Unit	Setting range	Specification
ZTM ON/OFF Synchronization of presser foot data in the teaching mode	-	OF ON	Sets synchronization of presser foot data in the teaching mode. Does not Synchronize presser foot data in the teaching mode. Synchronizes presser foot data in the teaching mode.
PFC ON/OFF of prohibition of presser foot up in non stitch feed.	-	OF ON	Sets ON/OFF of prohibition of presser foot up in non stitch feed. Presser foot up in non stitch feed. Presser foot never up in non stitch feed.
PFH ON/OFF of prohibition of presser foot inversion in non home position.	-	OF ON	Sets ON/OFF of presser foot inversion in non home position. Presser foot inverts regardless of home position. Presser foot inverts in home position only.
ZDE8 The angle which end point for PF going down	deg.	0 to ZUS8	Sets the angle which end point for PF going down.
ZUS8 The angle which start point for PF going up	deg.	ZDE8 to 359 ※	Sets the angle which start point for PF going up.
UW The delay time before PF going up motion	ms	1 to 9999	Sets the delay time before PF going up motion. (Auto sewing).
PU The delay time after PF going up motion	ms	1 to 9999	Sets the delay time after PF going up motion. (Auto sewing).
PD The delay time before PF going down motion	ms	1 to 9999	Sets the delay time before PF going down motion. (Auto sewing).
DW The delay time after PF going down motion	ms	1 to 9999	Sets the delay time after PF going down motion. (Auto sewing)
ZSTK The value of PF stroke code default	x0.1 mm	0 to 80 ※	Sets the value of PF stroke code default.
ZST1 The value of PF stroke code 1	x0.1 mm	0 to 80 ※	Sets the value of PF stroke code 1.

< Continuation of [ Presser foot ] >

Function	Unit	Setting range	Specification
ZST2 The value of PF stroke code 2	x0.1 mm	0 to 80 ※	Sets the value of PF stroke code 2.
ZTHK The value of PF height	x0.1 mm	0 to 80 ※	Sets the value of PF height.
ZTMG The timing of PF motion	deg	0 to 359	Sets the phase for PF going down. (valid when ZVRB = [ON] )
ZVRB ON/OFF of PF bottom keep motion	Sets valid/invalid the digital motion.		
	-	OF	Invalid bottom keep motion.
		ON	Valid bottom keep motion.
ZPWR The value of holding power default at PF bottom keep motion	%	30 to 200	Sets the value of holding power default at PF bottom keep motion. (valid when ZVRB = [ON] )
ZPW1 The value of holding power 1 at PF bottom keep motion	%	30 to 200	Sets the value of holding power 1 at PF bottom keep motion.(valid when ZVRB = [ON] )
ZPW2 The value of holding power 2 at PF bottom keep motion	%	30 to 200	Sets the value of holding power 2 at PF bottom keep motion. (valid when ZVRB = [ON] )
ZJUP ON/OFF of PF keeping up at JOG motion	Valid/Invalid rise the presser foot in JOG operation.		
	-	OF	Presser foot rises to the height of stitch data in JOG operation.
		ON	Presser foot rises to the height of feed data in JOG operation.
ZNPP Distance from PF sensor edge to the top surface of slide plate	x0.1 mm	0 to 500	Set the distance from PF sensor edge to the surface of slide plate. Please turn off the power after the setting change and restart again.
MSZS Rotation speed for needle and presser foot test run	rpm	10 to 200	Sets rotation speed for needle and presser foot test run
MSZN Rotation number for needle and presser foot test run	sti	1 to 10	Sets rotation number for needle and presser foot test run

※ Depending on the model, the setting range may be different.



## 11. Bobbin winding

Function	Unit	Setting range	Specification
W Bobbin winding speed setting	rpm	LOW to HIGH	Sets the speed of the sewing machine during bobbin winding.
WSM Bobbin winding operation setting	Sets the operation of the winder.		
	-	NO	While the operation signal SRT is turned [ON], the sewing machine rotates. When the signal is turned [OFF], the sewing machine stops.
		AL	When start signal SRT is turned ON, the sewing machine continues its operation. Furthermore, when the start signal SRT is ON, machine is stopped.
		T	When the operation signal SRT is turned [ON], the sewing machine continues to run within the time which is set in (WT.) function.
WT Bobbin winding operation time	s	1 to 500	Sets the bobbin winding operation time. (valid when WSM = [T] )

## 12. Feed method

Function	Unit	Setting range	Specification
WET Clamp weight selection	Sets the feeding method corresponding to the clamp weight. If the unusual clamp is adapted, please set the value corresponding to the clamp weight.		
	-	L	For standard delivery clamp [L].
		M	Heavy weight setting [M].
		H	Heavy weight setting [H].
WEL Setting value when clamp [L] is selected	%	1 to 100	SET value is applied when clamp weight selection (WET.) = [L]. It limits maximum sewing speed of each stitch length.
WEM Setting value when clamp [M] is selected	%	1 to 100	SET value is applied when clamp weight selection (WET.) = [M]. It limits maximum sewing speed of each stitch length.
WEH Setting value when clamp [H] is selected	%	1 to 100	Set value is applied when clamp weight selection (WET.) = [H]. It limits maximum sewing speed of each stitch length.
THI Cloth thickness selection	Table feed timing corresponding to the sewing material thickness can be selected. Set value according to the sewing material thickness. The number in the ( ) indicates the approximate thickness.		
	-	L	Standard setting [L]------(0-3mm).
		M	Thick material setting [M]---(3-6mm).
		H	Thick material setting [H]---(6-8mm).
TL Setting value when cloth thickness [L] is selected	%	1 to 100	Set value is applied when material thickness selection (THI.) = [L]. It limits maximum sewing speed of each stitch length. The factory setting is for approx. 0 to 3mm.
TM Setting value when cloth thickness [M] is selected	%	1 to 100	Set value is applied when material thickness selection (THI.) = [M]. It limits maximum sewing speed of each stitch length. The factory setting is for approx. 3 to 6mm.
TH Setting value when cloth thickness [H] is selected	%	1 to 100	Set value is applied when material thickness selection (THI.) = [H]. It limits maximum sewing speed of each stitch length. The factory setting is for approx. 6 to 8mm.

< Continuation of [ Feed method ] >

FEM Setting for non stitch feed	Non stitch feed tracks can be selected.		
	-	K	Non stitch feed which traces the inputted tracks (slower than [S] setting).
		S	Non stitch feed is moved at high speed. table moves diagonally (45 degree) at first, then moves either X or Y direction.
FSL Non stitch feed speed setting for long distance	-	0 to 9	Non stitch feed speed for long distance can be set from [0 (slow)] to [9 (fast)].
FSS Non stitch feed speed setting for short distance	-	0 to 9	Non stitch feed speed for short distance can be set from [0 (slow)] to [9 (fast)].
TSL Teaching speed setting for long distance	-	0 to 9	Teaching speed for long distance can be set from [0 (slow)] to [9 (fast)].
TSS Teaching speed setting for short distance	-	0 to 9	Teaching speed for short distance can be set from [0 (slow)] to [9 (fast)].
STQ DO NOT USE	-	1 to 30	DO NOT USE.
ZSL ON/OFF of main axis speed limit by presser foot motion	ON/OFF of main axis speed limit by presser foot motion.		
	-	OF	Invalidates main axis speed limit by presser foot motion.
		ON	Validates main axis speed limit by presser foot motion.
TPH Amount of maximum movement of the arrow input in the teaching mode.	x0.1 mm	1 to 200	Amount of maximum movement of the arrow input in the teaching mode.
TPY ON/OFF of the amount of maximum movement of the arrow input in the teaching mode.	Sets ON/OFF of the amount of maximum movement of the arrow input in the teaching mode.		
	-	OF	The value of the setting TPH is invalid.
		ON	The value of the setting TPH is valid.
LH Setting of length of continuous feed sew in maximum	x0.1 mm	1 to 200	The maximum stitch range can be specified for continuous feed sew.
FSH ON/OFF for max speed of continuous feeding becomes HIGH setting.	Sets ON/OFF for maximum sewing speed of continuous feeding become the setting HIGH. This setting is validated when the FED setting is S.		
	-	OF	Continuous feeding max speed not become HIGH set value.
		ON	Continuous feeding max speed become HIGH set value.
XSTQ Torque adjustment of X axis continuous feeding	%	25 to 175	Sets the torque adjustment of the X axis motor for continuous feed. (valid when FED = [S] )
YSTQ Torque adjustment of Y axis continuous feeding	%	25 to 175	Sets the torque adjustment of the Y axis motor for continuous feed. (valid when FED = [S] )
XSMO DO NOT USE	-	-10 to +10	DO NOT USE
YSMO DO NOT USE	-	-10 to +10	DO NOT USE

## 13. Speed

Function	Unit	Setting range	Specification
<b>HIGH</b> High speed	rpm	100 to 2500 ※	The speed of HIGH speed code can be set. (*1)
<b>LOW</b> Low speed	rpm	100 to 400 ※	The speed of LOW speed code can be set.
<b>MD1</b> Middle speed 1 [MD1]	rpm	LOW to HIGH	Speed for MD1 code (medium speed 1) can be set.
<b>MD2</b> Middle speed 2 [MD2]	rpm	LOW to HIGH	Speed for MD2 code (medium speed 2) can be set.
<b>CPSC</b> Corner sewing speed control ON/OFF		Switch ON/OFF of corner sewing speed control.	
	-	OF	Invalid the corner sewing speed control.
		ON	Valid the corner sewing speed control.
<b>CPLS</b> DO NOT USE	rpm	LOW to HIGH	DO NOT USE.
<b>CPS8</b> Angle setting for low speed of corner sewing speed control	deg	90 to 180	Set the low speed of corner sewing speed control. The corner is sewed over the this setting angle by decelerated speed.
<b>CPE8</b> Angle setting for high speed of corner sewing speed control	deg	0 to 90	Set the high speed of corner sewing speed control. The corner is sewed under the this setting angle by HIGH setting speed.
<b>OPLC</b> Valid/invalid of e-stitch motion feed at sewing start.		Sets valid/invalid of e-stitch motion feed at sewing start. It is possible to prevent for entanglement or skip stitch of starting sewing point.	
	-	OF	Invalidates of e-stitch motion feed at sewing start.
		ON	Validates of e-stitch motion feed at sewing start.
<b>OPLN</b> The stitch number of e-stitch motion feed at sewing start.	sti	1 to 100	Sets the stich number of e-stitch motion feed at sewing start.
<b>CPER</b> Setting the Speed of corner sewing	%	50 to 150	Sets the Speed of corner sewing. (%)

※ Depending on the model, the setting range may be different.

(\*1) The sewing speed might be limited according to the pitch, the setting of the thickness of the cloth, and the weight setting. The speed limit has priority when speed limit is lower than set value (HIGH, MD1, MD2).

## 14. Thread trimming / Thread release

Function	Unit	Setting range	Specification
<b>TRM</b> Thread trimming ON/OFF		Sets valid/invalid of the thread trimming.	
	-	OF	The thread trimming is invalidated.
		ON	The thread trimming is validated.

< Continuation of [ Thread trimming / Thread release ] >

Function	Unit	Setting range	Specification
<b>LTM</b> Setting for thread trimming output (T) timing.	Thread trimming output (T) timing can be set.		
	-	T1	Thread trimming is begun at TRS setting (degree) from needle down position, and is ended at TRE setting (time) from needle up position. Please refer to technical manual for details.
		T2	Thread trimming is begun at TRS setting (degree) from needle down position, and is ended at TRE setting (degree). Please refer to technical manual for details.
		T3	Thread trimming is begun at TRS setting (degree) from needle down position, and is ended at TRE setting (time). Please refer to technical manual for details.
		T4	Thread trimming is begun at TRS setting (time) from needle down position, and is ended at TRE setting (time) from needle down position. Please refer to technical manual for details.
T5		Thread tension release is begun at TRS setting (time) from needle up position, and is ended at TRE setting (time). Please refer to technical manual for details.	
<b>TRS</b> Thread trimming output start time/angle	ms/deg.	0 to 998	The output start time of the thread trimming output (T) can be set. Refer to technical manual for details.
<b>TRE</b> Thread trimming output time/angle	ms/deg.	0 to 998	The output end time of the thread trimming output (T) can be set. Refer to technical manual for details.
<b>T</b> Thread trimming speed	rpm	100 to LOW ※	Thread trimming speed between needle down position and needle up position can be set. Refer to timing chart for details.
<b>ETC</b> DO NOT USE	DO NOT USE		
	-	OF ON	DO NOT USE DO NOT USE
<b>LSP</b> ON/OFF of thread tension release output at presser foot up.	Sets ON/OFF of thread tension release output at presser foot up.		
	-	OF ON	Thread tension release output is not continued. Thread tension release output is continued.
<b>LLM</b> Setting for thread tension release output (L) timing	Thread tension release output (L) timing can be set. (Please refer to timing chart for details.)		
	-	L1	Thread tension release is begun at LRS setting (degree) from needle down position, and is ended at LRE setting (time) from needle up position. Please refer to technical manual for details.)
		L2	Thread tension release is begun at LRS setting (degree) from needle down position, and is ended at LRE setting (degree). Please refer to technical manual for details.)
		L3	Thread tension release is begun at LRS setting (degree) from needle down position, and is ended at LRE setting (time). Please refer to technical manual for details.)
		L4	Thread tension release is begun at LRS setting (time) from needle down position, and is ended at LRE setting (time) from needle down position. Please refer to technical manual for details.)
L5		Thread tension release is begun at LRS setting (time) from needle up position, and is ended at LRE setting (time). Please refer to technical manual for details.)	
<b>LRS</b> Thread release output start time/angle	ms/deg.	0 to 998	Start time/angle of thread release output can be set. Please refer to technical manual for details.

< Continuation of [ Thread trimming / Thread release ] >

Function	Unit	Setting range	Specification
LRE Thread release output time/angle	ms/ deg.	0 to 998	End time/angle of thread release output can be set. Please refer to technical manual for details.
LP Setting for tension release outputs time length at presser foot rise	s	0 to 10000	Outputs tension release signal when the presser foot goes up (valid when LSP = [OFF] )
LFP Setting of thread release output at presser foot up in non stitch feed.		Sets ON/OFF of prohibition of thread tension release output at presser foot up in non stitch feed (include JOG).	
	-	OF	Thread tension release output is done at presser foot up.
		ON	Thread tension release output is not done at presser foot up.
TRUD DO NOT USE		DO NOT USE.	
	-	OF	DO NOT USE.
		ON	DO NOT USE.

※ Depending on the model, the setting range may be different.

## 15. Step

Function	Unit	Setting range	Specification
STO Step sequence ON/OFF		Sets ON/OFF step sequence.	
	-	OF	Sets step sequence OFF.
		ON	Sets step sequence ON.
SUU Execution number of lines of one main loop in step sequence.	lines	1 to 50	Sets execution number of lines of one main loop in step sequence.
SP1 AND priority execution ON/OFF for step sequence		Sets AND priority execution ON/OFF for step sequence.	
	-	OF	Executes in order of the input.
		ON	Executed with giving priority to AND.
SOA ON/OFF of reversing function of customization at step sequence output.		It is used in step sequence output of reversing function that has been set in output customization.	
	-	OF	Disable reversing function that has been set in output customization.
		ON	Enable reversing function that has been set in output customization.
STO2 Step sequence 2		Sets ON/OFF step sequence 2.	
	-	OF	Set step sequence 2 OFF.
		ON	Set step sequence 2 ON.
SUU2 Execution number of lines of one main loop in step sequence 2.	lines	1 to 5	Sets execution number of lines of one main loop in step sequence 2.
SP2 AND priority execution for step sequence 2		Sets AND priority execution ON/OFF for step sequence.	
	-	OF	Executes in order of the input.
		ON	Executed with giving priority to AND.

< Continuation of [ Step ] >

Function	Unit	Setting range	Specification
SOA2 ON/OFF of reversing function of customization at step sequence 2 output.	-	OF	Disable reversing function that has been set in output customization.
		ON	Enable reversing function that has been set in output customization.
ANT0 Setting the threshold value of analog input 0	-	0 to 4095	Decide the threshold value for turning the customized output ANT 0 ON. The set value is the value obtained by digitally converting the input voltage of analog input [AN0]. Analog input [AN0] can input up to 12V.(*1)
ANT1 Setting the threshold value of analog input 1	-	0 to 4095	Decide the threshold value for turning the customized output ANT 1 ON. The set value is the value obtained by digitally converting the input voltage of analog input [AN1]. Analog input [AN1] can input up to 12V. (*1)
DALM Range of analog output	-	1 to 4095	Sets the range of analog output.

(\*1) For analog input, refer to page [15] - 7 " 3.ratings value of input / output" of the control device of Technical Data.

‡ When STO and STO 2 are used in parallel, depending on the program of the step, the calculation processing becomes heavy and the output etc. may not operate according to the assumed timing, so please use with care.

## 16. Jog

Function	Unit	Setting range	Specification
JGM JOG icon function setting	-	--	The XY table moves according to the pattern data while the JOG icon is ON, and stops when turned OFF.
		AL	The JOG [+] icon is turned ON: The XY table moves, automatically proceeds to the end point. The JOG [-] icon is turned ON: The XY table moves, automatically returns to the start point. During movement, the operation will stop if either of the JOG [+/-] icons is turned ON again.
		HA	The JOG [+] or [-] icon is turned ON until XY table reached at high speed: The XY table will automatically move to the end point or start point. If the icon is turned OFF before the high speed is reached, the operation will stop immediately. During movement, the operation will stop if either of the JOG [+/-] icons is turned ON again.
UJC Valid setting of JOG icon excluding needle UP position	-	OF	The JOG operation is possible only when the needle is at UP stop position.
		ON	The JOG operation is possible regardless needle position. Be aware that the JOG operation becomes valid even when the needle is in the fabric.
JGS DO NOT USE	-	OF	DO NOT USE.
		ON	DO NOT USE.
SJC ON/OFF of the smooth JOG	-	OF	The smooth JOG is invalid.
		ON	The smooth JOG is valid.

< Continuation of [ Jog ] >

Function	Unit	Setting range	Specification
JSS JOG speed setting	-	0 to 9	JOG speed can be set from [0 (slow)] to [9 (fast)].
NUUP Setting invalid the detecting up position in teaching / modify mode	-	OF	Detection of up position in teaching / modify mode.
		ON	No detection of up position in teaching / modify mode. ‡ Be aware that the JOG operation becomes valid even when the needle is in the fabric.
JEND Move to END code point from home position	-	OF	It is impossible to move directly to END code point from the home position by –JOG.
		ON	It is possible to move directly to END code point from the home position by –JOG.

## 17. Feed angle

Function	Unit	Setting range	Specification
S8C DO NOT USE	-	DO NOT USE.	
		OF	DO NOT USE.
E8C DO NOT USE	-	ON	DO NOT USE.
		OF	DO NOT USE.
X8C DO NOT USE	-	ON	DO NOT USE.
		OF	DO NOT USE.
XS8 DO NOT USE	deg.	0 to 356	DO NOT USE.
XE8 DO NOT USE	deg.	0 to 356	DO NOT USE.
XT8 DO NOT USE	deg.	0 to 356	DO NOT USE.
YS8 DO NOT USE	deg.	0 to 356	DO NOT USE.
YE8 DO NOT USE	deg.	0 to 356	DO NOT USE.
YT8 DO NOT USE	deg.	0 to 356	DO NOT USE.
XUNW X M3 width cord setting value default at M3 sewing motion	%	1 to 100	X M3 width cord setting value default at M3 sewing motion. (Low speed)
XUN1 X M3 width cord setting value 1 at M3 sewing motion	%	1 to 100	X M3 width cord setting value 1 at M3 sewing motion. (Low speed)
XUN2 X M3 width cord setting value 2 at M3 sewing motion	%	1 to 100	X M3 width cord setting value 2 at M3 sewing motion. (Low speed)
YUNW Y M3 width cord setting value default at M3 sewing motion	%	1 to 100	Y M3 width cord setting value default at M3 sewing motion. (Low speed)

< Continuation of [ Feed angle ] >

Function	Unit	Setting range	Specification
YUN1 Y M3 width cord setting value 1 at M3 sewing motion	%	1 to 100	Y M3 width cord setting value 1 at M3 sewing motion. (Low speed)
YUN2 Y M3 width cord setting value 2 at M3 sewing motion	%	1 to 100	Y M3 width cord setting value 2 at M3 sewing motion. (Low speed)
XUNS X M3 slant at M3 sewing motion	%	25 to 75	X M3 slant at M3 sewing motion.
YUNS Y M3 slant at M3 sewing motion	%	25 to 75	Y M3 slant at M3 sewing motion.

## 18. Communication

Function	Unit	Setting range	Specification
SC1 DO NOT USE		DO NOT USE.	
	-	OF	DO NOT USE.
		ON	DO NOT USE .
BR1 DO NOT USE		DO NOT USE.	
	-	96	DO NOT USE.
		384	DO NOT USE.
		576	DO NOT USE.
		1152	DO NOT USE.
		OF	DO NOT USE.
BM1 DO NOT USE	x100 bps	96 to 2560	DO NOT USE.
UAT Sewing operation ON/OFF when USB memory is connected		Sets sewing operation ON/OFF when USB memory is connected.	
	-	OF	Sewing operation is permitted regardless USB memory connection.
		ON	Sewing operation is prohibited when USB memory is connected.
UBCV ON/OFF of valid for USB barcode reader		Valid/Invalid USB barcode reader.	
	-	OF	Invalid USB barcode reader.
		ON	Valid USB barcode reader.
UBCT The timing of reading the barcode for USB barcode reader		Reading timing of the USB bar cord reader.	
	-	OF	Reading the pattern number by customize signal (BCDR) on timing.
		ON	Reading the pattern number by clamp on timing.
UBDI ON/OFF of valid for recording information data for USB barcode reader		Valid/Invalid the ID and pattern read data accumulation of USB barcode reader.	
	-	OF	Invalid the ID and pattern read data accumulation of USB barcode reader.
		ON	Valid the ID and pattern read data accumulation of USB barcode reader.
PTOW Setting valid of overwrite the current pattern data by USB communication		Sets valid/invalid of overwrite the current pattern data by USB communication.	
	-	OF	Sets the invalid of overwrite the current pattern data by USB communication.
		ON	Sets the valid of overwrite the current pattern data by USB communication.



< Continuation of [ Communication ] >

Function	Unit	Setting range	Specification
ICCS Input port control by CC-Link communication.	Valid/invalid of input port control by CC-Link communication.		
	-	OF	Invalid of input port control by CC-Link communication.
		ON	Valid of input port control by CC-Link communication.
OCCS Output port control by CC-Link communication.	Valid/invalid of output port control by CC-Link communication.		
	-	OF	Invalid of output port control by CC-Link communication.
		ON	Valid of output port control by CC-Link communication.
CCEN Setting of CC-Link communication.	Valid/invalid of CC-Link communication.		
	-	OF	Invalid of CC-Link communication.
		ON	Valid of CC-Link communication.

## 19. Digital tension

Function	Unit	Setting range	Specification
DTSN ON/OFF of valid for Digital tension	Select the digital tension function mode. ‡ Please turn off the power after the setting change and restart again.		
	-	OF	Digital tension is possible to operate by manual. Tension value is displayed on the panel.
		PT	Digital tension operate automatically by the sewing data. It can not be operated manually.
		AT	Digital tension operate automatically by the sewing direction. It can not be operated manually.
		ME	Memorize the position of digital tension.
DTST Sets value of the digital tension code default	-	0.5 to 100.0	Digital tension code default setting value.
DTS1 Sets value of the digital tension code 1	-	0.5 to 100.0	Digital tension code 1 setting value.
DTS2 Sets value of the digital tension code 2	-	0.5 to 100.0	Digital tension code 2 setting value.
DTMX Digital tension maximum position (100.0)	pulse	DTMN. to 16000	Sets the maximum position (100.0) of digital tension.
DTMN Digital tension zero position (0.0)	pulse	0. to DTMX	Sets the zero position (0.0) of digital tension.
DTA0 Digital tension direction 0 deg	%	10 to 300	Sets the digital tension value of the 0 degree sewing direction.
DTA1 Digital tension direction 45 deg	%	10 to 300	Sets the digital tension value of the 45 degree sewing direction.
DTA2 Digital tension direction 90 deg	%	10 to 300	Sets the digital tension value of the 90 degree sewing direction.
DTA3 Digital tension direction 135 deg	%	10 to 300	Sets the digital tension value of the 135 degree sewing direction.

< Continuation of [ Digital tension ] >

Function	Unit	Setting range	Specification
DTA4 Digital tension direction 180 deg	%	10 to 300	Sets the digital tension value of the 180 degree sewing direction.
DTA5 Digital tension direction 225 deg	%	10 to 300	Sets the digital tension value of the 225 degree sewing direction.
DTA6 Digital tension direction 270 deg	%	10 to 300	Sets the digital tension value of the 270 degree sewing direction.
DTA7 Digital tension direction 315 deg	%	10 to 300	Sets the digital tension value of the 315 degree sewing direction.
DTLP The distance that memorized digital tension position by manual setting.	pulse	0 to 64	Set the distance that memorized digital tension position by manual setting.
DTPP The memorized digital tension position by manual setting.	pulse	0 to 65535	Set the memorized digital tension position by manual setting.

## 20. Oil lubrication

Function	Unit	Setting range	Specification
OILV ON/OFF of oil lubrication output	Valid/Invalid oil lubrication output.		
	-	OF	Invalid oil lubrication output.
		ON	Valid oil lubrication output.
OL1C Stitch number of oil lubrication output 1	x100 sti	0 to 200	Sets the stitch number of oil lubrication output 1 until oil lubrication.
OL1T Time of oil lubrication output 1	x100 ms	1 to 100	Sets the time of oil lubrication output 1 until oil lubrication.
OL2C Stitch number of oil lubrication output 2	x100 sti	0 to 200 ※	Sets the stitch number of oil lubrication output 2 until oil lubrication.
OL2T Time of Oil lubrication output 2	x100 ms	1 to 100	Sets the time of oil lubrication output 2 until oil lubrication.

※ Depending on the model, the setting range may be different.

## 21. Other

Function	Unit	Setting range	Specification
BOM ON/OFF of the control box temperature warning	Sets valid/invalid for the control box temperature warning detection.		
	-	OF	Invalidates control box temperature warning detection.
		ON	Validates control box temperature warning detection.

< Continuation of [ Other ] >

Function	Unit	Setting range	Specification
CDD Display of code in image setting	The method of displaying the code of the sewing data image display is set.		
	-	DP	The content of the code is displayed.
		CR	All the codes are displayed by "Circle".
		NO	The code is not displayed.
GPL ON/OFF of communication error detection with operation panel	Sets communication error detection when the operation panel is not connected with the control box.		
	-	OF	Validates communication error detection with operation panel.
		ON	Invalidates communication error detection with operation panel.
CMIF Sets ON/OFF of clearing the multi information window	Sets ON/OFF of clearing the multi information window when sewing starts.		
	-	OF	Invalid of clearing the multi information window when sewing starts.
		ON	Valid of clearing the multi information window when sewing starts.

## 22. Pattern

Function	Unit	Setting range	Specification
APC Pattern select function by external signal <TURN OFF THE POWER>	The sewing data selection method is set. ‡ Please turn off the power after the setting change and restart again.		
	-	OF	Selects sewing pattern data number by using the operation panel.
		ON	Select sewing pattern number by using external signal. In this case input customize setting is ignored.
POF Pattern offset selection by external signal	Offset number for pattern data number selection by using external signal.		
	-	10	Sewing data number becomes specified number +1000.
		20	Sewing data number becomes specified number +2000.
		30	Sewing data number becomes specified number +3000.
		40	Sewing data number becomes specified number +4000.
PTC Change in setting table number from the sewing data	Selects setting table change action at the pattern data change.		
	-	OF	The change in the setting table number from the sewing data is unavailable.
		ON	The change in the setting table number from the sewing data is available.
PT1 DO NOT USE	DO NOT USE.		
		OF	DO NOT USE.
		ON	DO NOT USE.
APT Setting of pattern selection timing by using of external signal	Chooses sewing pattern number switching timing by using external signal.		
	-	OF	The pattern number is changed at the sewing end, at the beginning of sewing or at the beginning of +Jog.
		ON	When a new pattern number is input, it is switched immediately. (However, only at home position)
M2H Second home positioning operation with pattern data which includes second home position	Selects second home positioning operation with pattern data which includes second home position.		
	-	OF	When pattern data which includes second home position is read, machine does not move to second home position automatically.
		ON	When pattern data which includes second home position is read, machine moves to second home position automatically.

< Continuation of [ Pattern ] >

Function	Unit	Setting range	Specification
<b>PKY</b> It release or not release the selected pattern data after sewing machine rotation.	Setting of whether to release the selected sewing pattern data after sewing machine rotation, when the sewing pattern data selection by serial communication is effective.		
	-	OF	When the sewing pattern data selection by barcode reader is effective, the selected sewing pattern data is not released after sewing machine rotation.
		ON	When the sewing pattern data selection by barcode reader is effective, the selected sewing pattern data is released after sewing machine rotation. Please select the sewing pattern data by barcode reader again. (valid when UBCV = [ON] )
<b>ASR</b> Setting of the unit of the time that is stopped by ASRT code.	Sets the unit of the time from stop by the ASRT code during sewing machine rotation to sewing again.		
	-	1000	The unit of the time that is stopped by the ASRT code is set to 1 sec (1000msec).
		500	The unit of the time that is stopped by the ASRT code is set to 0.5 sec (500msec).
		200	The unit of the time that is stopped by the ASRT code is set to 0.2 sec (200msec).
<b>HPW</b> Setting presser foot height in pattern data	Sets USE/NOT USE of PF height in pattern data.		
	-	OF	Not use PF height in pattern data. (Use PF height in machine)
		ON	Use PF height in pattern data. (Not use PF height in machine)
<b>DTPW</b> Setting digital tension position in pattern data	Sets USE/NOT USE of digital tension value in pattern data.		
	-	OF	Not use digital tension value in pattern data. (Use digital tension value in machine)
		ON	Use digital tension value in pattern data. (Not use digital tension value in machine)

## 23. Traceability

Function	Unit	Setting range	Specification
<b>ZDS1</b> Material detect speed 1 initial	-	1 to 100	Sets speed of the position to switch speed when material detect.
<b>ZDS2</b> Material detect speed 2 initial	-	10 to 100	Sets speed of the detection position when material detect.
<b>ZDSQ</b> Material detect pressure setting initial	x0.1%	150 to 1000	Sets the material detect torque setting.
<b>ZDST</b> Material detect judgment time initial	ms	50 to 1000	Sets the material detect judgment time.
<b>ZDSL</b> Material detect judgment range initial	x0.1 mm	0 to 100	Sets the material detect judgment range.

**IMPORTANT**

Abnormal stitch detect function is “not able to detect the abnormal stitch perfectly, and there is not guarantee it”.

This function is notice function to customer that detect the suspicion of skip stitch or thread breakage etc.

Please adjust the detect timing etc. by using each setting.

< Continuation of [ Traceability ] >

Function	Unit	Setting range	Specification
SKCF Valid/invalid of the stitch abnormality detection	Valid/invalid of stopping sewing when the abnormal stitch is detected.		
	-	OF	It do not stop sewing when the abnormal stitch is detected.
		ON	It stop sewing when the abnormal stitch is detected.
SKN1 The number of ignore stitches of the abnormal stitch detection before sewing start.	sti	1 to 9	The number of ignore stitches of the abnormal stitch detection after sewing start can be set.
SKN2 Invalid stitches of the abnormal stitch detection.	sti	1 to 9	The number of valid stitches which is detected by the abnormal stitch detection sensor can be set.
SKSP Rotation speed to disregard the abnormal stitch detection.	rpm	LOW to HIGH	Rotation speed to disregard the abnormal stitch detection sensor can be set.
SKFL The filter number for the abnormal stitch detection sensor.	time	1 to 99	The filter number for the abnormal stitch detection sensor can be set.
SKN3 The number of ignore stitches of the abnormal stitch detection before sewing end	sti	1 to 9	The number of ignore stitches of the abnormal stitch detection before sewing end can be set.
SKCS The angle for judgement starting of abnormal stitch detection	deg	0 to 359	Sets the angle for judgement starting of abnormal stitch detection.
SKTI The threshold for judgement time of abnormal stitch detection	x0.1 ms	1 to 10000	Sets the threshold for judgement time of abnormal stitch detection.
SKTD The threshold for judgement unit of abnormal stitch detection	Sets the threshold for judgement unit of abnormal stitch detection.		
	-	TI	The threshold for judgement unit of abnormal stitch detection set to time.
		DE	The threshold for judgement unit of abnormal stitch detection set to angle.
SKDE The threshold for judgement angle of abnormal stitch detection	deg	0 to 180	Sets the threshold for judgement angle of abnormal stitch detection.

< Continuation of [ Traceability ] >

Function	Unit	Setting range	Specification
<b>SKTP</b> The timing for sewing stop of abnormal stitch detection	Sets the timing for sewing stop of abnormal stitch detection.		
	-	NW	It stop sewing immediately when the abnormal stitch is detected.
		ED	It stop after sewing end when the abnormal stitch is detected.
<b>S2CF</b> The abnormal stitch detection 2	Valid/invalid of stopping sewing when the abnormal stitch 2 is detected.		
	-	OF	It do not stop sewing when the abnormal stitch 2 is detected.
		ON	It stop sewing when the abnormal stitch 2 is detected.
<b>S2N1</b> The number of ignore stitches of the abnormal stitch detection 2 after sewing start	sti	1 to 9	The number of ignore stitches of the abnormal stitch detection 2 after sewing start can be set.
<b>S2N2</b> Invalid stitches of the abnormal stitch detection 2	sti	1 to 9	The number of valid stitches which is detected by the abnormal stitch detection sensor 2 can be set.
<b>S2SP</b> Rotation speed disregard the abnormal stitch detection 2	rpm	LOW to HIGH	Rotation speed to disregard the abnormal stitch detection sensor 2 can be set.
<b>S2FL</b> The filter number for sensor of the abnormal stitch detection 2	time	1 to 99	The filter number for the abnormal stitch detection sensor 2 can be set.
<b>S2N3</b> The number of ignore stitches of the abnormal stitch detection 2 before sewing end	sti	1 to 9	The number of ignore stitches of the abnormal stitch detection 2 before sewing end can be set.
<b>S2CE</b> The angle for judgement ending of abnormal stitch detection 2	deg	0 to 359	Sets the angle for judgement ending of abnormal stitch detection 2.
<b>S2TP</b> The timing for sewing stop of abnormal stitch detection 2	Sets the timing for sewing stop of abnormal stitch detection 2.		
	-	NW	It stop sewing immediately when the abnormal stitch 2 is detected.
		ED	It stop after sewing end when the abnormal stitch 2 is detected.
<b>ZDSP</b> The height which start the material detect speed 2	0.1mm	1 to 150	Sets the height which start the material detect speed 2.
<b>ZDHD</b> The delay time which switch from PF home positioning to the material detect speed 1	ms	250 to 1000	Sets the delay time which switch from PF home positioning to the material detect speed 1.
<b>ZDSD</b> The delay time which switch from the material detect speed 1 to the material detect speed 2	ms	500 to 2000	Sets the delay time which switch from the material detect speed 1 to the material detect speed 2.

< Continuation of [Traceability] >

Function	Unit	Setting range	Specification
FFSX Rotation speed to disregard FF-stitch for X direction.	rpm	200 to 2000	Rotation speed to disregard FF-stitch for X direction can be set.
FFSY Rotation speed to disregard FF-stitch for Y direction.	rpm	200 to 2000	Rotation speed to disregard FF-stitch for Y direction can be set.

## [21] Error / Message display

### 1. [E-\*\*\*\*] Error code

- When the error message is displayed, confirm the contents and investigate according to the following table.
- The machine can be restored to the normal mode by turning off the power once and turning on again.

CODE	ERROR NAME	PROBABLE CAUSE	INSPECTION
E-0001	MAIN AXIS OVERCURRENT ERROR	-Wiring to the main servo motor is short-circuited. -The load torque of the main axis is too large.	<ul style="list-style-type: none"> <li>· Check the wiring for the main motor.</li> <li>· Check the sewing machine.</li> </ul>
E-0002	MAIN MOTOR ENCODER ERROR	<ul style="list-style-type: none"> <li>· The main servo encoder connector has not been firmly inserted.</li> <li>· The signal from the main servo encoder has been disconnected.</li> </ul>	<ul style="list-style-type: none"> <li>· Check the insertion of the connector.</li> <li>· Check the encoder signal by using IN/OUT setting mode.</li> </ul>
E-0003	MAIN MOTOR U PHASE CURRENT OFFSET ERROR	<ul style="list-style-type: none"> <li>· There is a trouble in the U-phase Current detection circuit on the SRV board.</li> </ul>	<ul style="list-style-type: none"> <li>· Exchange the SRV board.</li> <li>· Please consult sewing machine shop of the order.</li> </ul>
E-0004	MAIN MOTOR V PHASE CURRENT OFFSET ERROR	<ul style="list-style-type: none"> <li>· There is a trouble in the V-phase Current detection circuit on the SRV board.</li> </ul>	<ul style="list-style-type: none"> <li>· Exchange the SRV board.</li> <li>· Please consult sewing machine shop of the order.</li> </ul>
E-0005	MAIN MOTOR LOCK ERROR	<ul style="list-style-type: none"> <li>· The main servo encoder connector has not been firmly inserted.</li> <li>· The signal from the main servo encoder has been disconnected.</li> <li>· The main servo motor is locked.</li> <li>· The sewing machine is locked.</li> </ul>	<ul style="list-style-type: none"> <li>· Check the insertion of the connector.</li> <li>· Check the encoder signal by using IN/OUT setting mode.</li> <li>· Check the main servo motor.</li> <li>· Check the sewing machine.</li> </ul>
E-0006	MAIN MOTOR PHASE DEFECT ERROR	<ul style="list-style-type: none"> <li>· Wiring to the main servo motor has been disconnected.</li> </ul>	<ul style="list-style-type: none"> <li>· Check the wiring of the main servo motor.</li> </ul>
E-0007	MAIN MOTOR ENCODER COMMUNICATION ERROR 1	<ul style="list-style-type: none"> <li>· The main servo encoder connector has not been firmly inserted.</li> <li>· The signal from the main servo encoder has been disconnected.</li> </ul>	<ul style="list-style-type: none"> <li>· Check the insertion of the connector.</li> <li>· Check the encoder signal by using IN/OUT setting mode.</li> </ul>
E-0008	MAIN MOTOR ENCODER COMMUNICATION ERROR 2	<ul style="list-style-type: none"> <li>· The main servo encoder connector has not been firmly inserted.</li> <li>· The signal from the main servo encoder has been disconnected.</li> <li>· Abnormality / breakdowns of the main servo encoder.</li> </ul>	<ul style="list-style-type: none"> <li>· Check the insertion of the connector.</li> <li>· Check the wiring of the main servo encoder.</li> <li>· Check the encoder signal by using IN/OUT setting mode.</li> </ul>
E-0009	MAIN MOTOR ENCODER COMMUNICATION ERROR 3		
E-0010	MAIN MOTOR ENCODER COMMUNICATION ERROR 4		
E-0011	MAIN MOTOR ENCODER COMMUNICATION ERROR 5		
E-0012	MAIN MOTOR HOME POSITION ERROR		
E-0013	MAIN MOTOR ENCODER DN DETECTOR ERROR		
E-0014	MAIN MOTOR ENCODER COMMUNICATION ERROR 6		



CODE	ERROR NAME	PROBABLE CAUSE	INSPECTION
E-0015	SUB MOTOR OVERCURRENT ERROR	<ul style="list-style-type: none"> <li>Wiring to the sub servo motor is short-circuited.</li> <li>The load torque of the sub axis is too large.</li> </ul>	<ul style="list-style-type: none"> <li>Check the wiring of the sub servo motor.</li> <li>Check the sewing machine.</li> </ul>
E-0016	SUB MOTOR ENCODER ERROR	<ul style="list-style-type: none"> <li>The sub servo encoder connector has not been firmly inserted.</li> <li>The signal from the sub servo encoder has been disconnected.</li> </ul>	<ul style="list-style-type: none"> <li>Check the insertion of the connector.</li> <li>Check the encoder signal by using IN/OUT setting mode.</li> </ul>
E-0017	SUB MOTOR U PHASE CURRENT OFFSET ERROR	<ul style="list-style-type: none"> <li>There is a trouble in the U-phase Current detection circuit on the SRV board.</li> </ul>	<ul style="list-style-type: none"> <li>Exchange the SRV board.</li> <li>Please consult sewing machine shop of the order.</li> </ul>
E-0018	SUB MOTOR V PHASE CURRENT OFFSET ERROR	<ul style="list-style-type: none"> <li>There is a trouble in the V-phase Current detection circuit on the SRV board.</li> </ul>	<ul style="list-style-type: none"> <li>Exchange the SRV board.</li> <li>Please consult sewing machine shop of the order.</li> </ul>
E-0019	SUB MOTOR LOCK ERROR	<ul style="list-style-type: none"> <li>The sub servo encoder connector has not been firmly inserted.</li> <li>The signal from the sub servo encoder has been disconnected.</li> <li>The sub servo motor is locked.</li> <li>The sewing machine is locked.</li> </ul>	<ul style="list-style-type: none"> <li>Check the insertion of the connector.</li> <li>Check the encoder A/B phase signal by IN/OUT setting mode.</li> <li>Check the sub servo motor.</li> <li>Check the sewing machine.</li> </ul>
E-0020	SUB MOTOR PHASE DEFECT ERROR	<ul style="list-style-type: none"> <li>Wiring to the sub servo motor has been disconnected.</li> </ul>	<ul style="list-style-type: none"> <li>Check the wiring of the sub servo motor.</li> </ul>
E-0021	SUB MOTOR ENCODER COMMUNICATION ERROR 1	<ul style="list-style-type: none"> <li>The main servo encoder connector has not been firmly inserted.</li> <li>The signal from the main servo encoder has been disconnected.</li> </ul>	<ul style="list-style-type: none"> <li>Check the insertion of the connector.</li> <li>Check the encoder A/B phase signal by IN/OUT setting mode.</li> </ul>
E-0022	SUB MOTOR ENCODER COMMUNICATION ERROR 2	<ul style="list-style-type: none"> <li>The sub servo encoder connector has not been firmly inserted.</li> <li>The signal from the sub servo encoder has been disconnected.</li> <li>Abnormality / breakdowns of the sub servo encoder.</li> </ul>	<ul style="list-style-type: none"> <li>Check the insertion of the connector.</li> <li>Check the wiring of the sub servo encoder.</li> <li>Check the encoder signal by using IN/OUT setting mode.</li> </ul>
E-0023	SUB MOTOR ENCODER COMMUNICATION ERROR 3		
E-0024	SUB MOTOR ENCODER COMMUNICATION ERROR 4		
E-0025	SUB MOTOR ENCODER COMMUNICATION ERROR 5		
E-0026	OVER BUS VOLTAGE	<ul style="list-style-type: none"> <li>Power supply voltage is too high than the power supply specification.</li> </ul>	<ul style="list-style-type: none"> <li>Check the power supply voltage.</li> </ul>
E-0027	BUS VOLTAGE SHORTAGE	<ul style="list-style-type: none"> <li>Power supply voltage is too low the power supply specification.</li> </ul>	<ul style="list-style-type: none"> <li>Check the power supply voltage.</li> </ul>
E-0029	SUB MOTOR ENCODER COMMUNICATION ERROR 6	<ul style="list-style-type: none"> <li>the sub servo encoder has been disconnected.</li> <li>Abnormality / breakdowns of the sub servo encoder.</li> </ul>	<ul style="list-style-type: none"> <li>Check the wiring of the sub servo encoder.</li> <li>Check the encoder signal by using IN/OUT setting mode.</li> </ul>
E-1033	IPM1 OVERCURRENT ERROR	<ul style="list-style-type: none"> <li>Wiring to the X axis stepping motor is short circuited.</li> <li>The load on the XY table is too large.</li> </ul>	<ul style="list-style-type: none"> <li>Check the wiring of the X axis stepping motor.</li> <li>Check the sewing machine.</li> </ul>

CODE	ERROR NAME	PROBABLE CAUSE	INSPECTION
E-1034	X MOTOR ENCODER ERROR	<ul style="list-style-type: none"> <li>The X axis encoder connector has not been firmly inserted.</li> <li>The signal from the X axis encoder has been disconnected.</li> </ul>	<ul style="list-style-type: none"> <li>Check the insertion of the connector.</li> <li>Check the encoder signal by using IN/OUT setting mode.</li> </ul>
E-1035	X MOTOR A PHASE CURRENT OFFSET ERROR	<ul style="list-style-type: none"> <li>There is a trouble of current detection circuit on the PMD board.</li> </ul>	<ul style="list-style-type: none"> <li>Exchange the PMD board.</li> <li>Please consult sewing machine shop of the order.</li> </ul>
E-1036	X MOTOR B PHASE CURRENT OFFSET ERROR	<ul style="list-style-type: none"> <li>There is a trouble of current detection circuit on the PMD board.</li> </ul>	<ul style="list-style-type: none"> <li>Exchange the PMD board.</li> <li>Please consult sewing machine shop of the order.</li> </ul>
E-1037	X MOTOR A PHASE ADSORPTION ERROR	<ul style="list-style-type: none"> <li>Clamp X position is at the end of the sewing area or clamp is hit to obstacle.</li> </ul>	<ul style="list-style-type: none"> <li>Check the clamp position.</li> </ul>
E-1038	X MOTOR HOME POSITION ERROR	<ul style="list-style-type: none"> <li>The connector of X axis home position sensor has not been firmly inserted.</li> <li>The signal from the X axis home position sensor has been disconnected.</li> </ul>	<ul style="list-style-type: none"> <li>Check the insertion of the connector.</li> <li>Check the X axis home position signal by using IN/OUT setting mode.</li> </ul>
E-1039	X MOTOR PHASE DEFECT ERROR	<ul style="list-style-type: none"> <li>The connector of X axis motor cable has not been firmly inserted.</li> <li>The X axis stepping motor cable has been disconnected.</li> </ul>	<ul style="list-style-type: none"> <li>Check the insertion of the connector.</li> <li>Check the X axis stepping motor cable.</li> </ul>
E-1040	IPM2 OVERCURRENT ERROR	<ul style="list-style-type: none"> <li>Wiring to the X axis stepping motor or the PF axis stepping motor is short circuited.</li> <li>The load on the XY table or the PF axis is too large.</li> </ul>	<ul style="list-style-type: none"> <li>Check the wiring of the X axis stepping motor wiring or PF axis stepping motor.</li> <li>Check the sewing machine.</li> </ul>
E-1041	Y MOTOR ENCODER ERROR	<ul style="list-style-type: none"> <li>The Y axis encoder connector has not been firmly inserted.</li> <li>The signal from the Y axis encoder has been disconnected.</li> </ul>	<ul style="list-style-type: none"> <li>Check the insertion of the connector.</li> <li>Check the encoder signal by using IN/OUT setting mode.</li> </ul>
E-1042	Y MOTOR A PHASE CURRENT OFFSET ERROR	<ul style="list-style-type: none"> <li>There is a trouble of current detection circuit on the PMD board.</li> </ul>	<ul style="list-style-type: none"> <li>Exchange the PMD board.</li> <li>Please consult sewing machine shop of the order.</li> </ul>
E-1043	Y MOTOR B PHASE CURRENT OFFSET ERROR	<ul style="list-style-type: none"> <li>There is a trouble of current detection circuit on the PMD board.</li> </ul>	<ul style="list-style-type: none"> <li>Exchange the PMD board.</li> <li>Please consult sewing machine shop of the order.</li> </ul>
E-1044	Y MOTOR A PHASE ADSORPTION ERROR	<ul style="list-style-type: none"> <li>Clamp Y position is at the end of the sewing area or clamp is hit to obstacle.</li> </ul>	<ul style="list-style-type: none"> <li>Check the clamp position.</li> </ul>
E-1045	Y MOTOR HOME POSITION ERROR	<ul style="list-style-type: none"> <li>The connector of Y axis home position sensor has not been firmly inserted.</li> <li>The signal from the Y axis home position sensor has been disconnected.</li> </ul>	<ul style="list-style-type: none"> <li>Check the insertion of the connector.</li> <li>Check the Y axis home position signal by using IN/OUT setting mode.</li> </ul>
E-1046	Y MOTOR PHASE DEFECT ERROR	<ul style="list-style-type: none"> <li>The connector of Y axis motor cable has not been firmly inserted.</li> <li>The Y axis stepping motor cable has been disconnected.</li> </ul>	<ul style="list-style-type: none"> <li>Check the insertion of the connector.</li> <li>Check the Y axis stepping motor cable.</li> </ul>

CODE	ERROR NAME	PROBABLE CAUSE	INSPECTION
E-1047	IPM3 OVERCURRENT ERROR	<ul style="list-style-type: none"> <li>Wiring to the Y axis stepping motor or the PF axis stepping motor is short circuited.</li> <li>The load on the XY table or the PF axis is too large.</li> </ul>	<ul style="list-style-type: none"> <li>Check the wiring of the Y axis or PF axis stepping motor.</li> <li>Check the sewing machine.</li> </ul>
E-1048	Z MOTOR ENCODER ERROR	<ul style="list-style-type: none"> <li>The PF axis encoder connector has not been firmly inserted.</li> <li>The signal from the PF axis encoder has been disconnected.</li> </ul>	<ul style="list-style-type: none"> <li>Check the insertion of the connector.</li> <li>Check the encoder signal by using IN/OUT setting mode.</li> </ul>
E-1049	Z MOTOR A PHASE CURRENT OFFSET ERROR	<ul style="list-style-type: none"> <li>There is a trouble of current detection circuit on the PMD board.</li> </ul>	<ul style="list-style-type: none"> <li>Exchange the PMD board.</li> <li>Please consult sewing machine shop of the order.</li> </ul>
E-1050	Z MOTOR B PHASE CURRENT OFFSET ERROR	<ul style="list-style-type: none"> <li>There is a trouble of current detection circuit on the PMD board.</li> </ul>	<ul style="list-style-type: none"> <li>Exchange the PMD board.</li> <li>Please consult sewing machine shop of the order.</li> </ul>
E-1051	Z MOTOR A PHASE ADSORPTION ERROR	<ul style="list-style-type: none"> <li>The position of the presser foot is at the lower end or the presser foot is hit to obstacle.</li> </ul>	<ul style="list-style-type: none"> <li>Check the presser foot position.</li> </ul>
E-1052	Z MOTOR HOME POSITION ERROR	<ul style="list-style-type: none"> <li>The connector of PF axis home position sensor has not been firmly inserted.</li> <li>The signal from the PF axis home position sensor has been disconnected.</li> </ul>	<ul style="list-style-type: none"> <li>Check the insertion of the connector.</li> <li>Check the PF axis home position signal by using IN/OUT setting mode.</li> </ul>
E-1053	Z MOTOR PHASE DEFECT ERROR	<ul style="list-style-type: none"> <li>The connector of PF axis stepping motor cable has not been firmly inserted.</li> <li>The PF axis stepping motor cable has been disconnected.</li> </ul>	<ul style="list-style-type: none"> <li>Check the insertion of the connector.</li> <li>Check the PF axis stepping motor cable.</li> </ul>
E-1054	IPM4 OVERCURRENT ERROR	<ul style="list-style-type: none"> <li>Wiring to the Y axis stepping motor is short circuited.</li> <li>The load on the XY table is too large.</li> </ul>	<ul style="list-style-type: none"> <li>Check the wiring of the Y axis stepping motor.</li> <li>Check the sewing machine.</li> </ul>
E-2065	POWER SUPPLY FAULT 1	<ul style="list-style-type: none"> <li>Internal 12 V power is decrease or short-circuited by trouble in the CPU board.</li> <li>Internal 12 V power is decrease or short-circuited by trouble in the SRV board.</li> </ul>	<ul style="list-style-type: none"> <li>Remove faulty point and exchange F1 fuse on the CPU board.</li> </ul>
E-2066	POWER SUPPLY FAULT 2	<ul style="list-style-type: none"> <li>External 12V power is short-circuited or decrease by the trouble of the operation panel.</li> <li>External 12V power is short-circuited or decrease by the trouble of the I/F board or the halt switch lamp.</li> </ul>	<ul style="list-style-type: none"> <li>Remove faulty point and exchange F2 fuse on the CPU board.</li> </ul>
E-2067	POWER SUPPLY FAULT 3	<ul style="list-style-type: none"> <li>There is a trouble in the CPU board or 5V power supply is short-circuited.</li> </ul>	<ul style="list-style-type: none"> <li>Check the encoder cable.</li> <li>Exchange the CPU board.</li> </ul>

CODE	ERROR NAME	PROBABLE CAUSE	INSPECTION
E-2068	TEMPERATURE ANOMALY 1	<ul style="list-style-type: none"> <li>The load torque of the sewing machine is too large.</li> <li>Solenoid valve output (O1 to OR ) and axis P1 or P2 axis motor is an overload.</li> </ul>	<ul style="list-style-type: none"> <li>Check the sewing machine</li> <li>Check the output current 24 V used with the I/F board etc.</li> </ul> Attention) Turn on the power again after the internal temperature of the control unit rises or falls. (Please the ambient temperature in more than 5°C and 35°C or less.)
E-2069	USB OVERCURRENT ERROR 1	<ul style="list-style-type: none"> <li>The USB medium connected to PAL is faulty.</li> <li>Non standard USB medium being used.</li> </ul>	<ul style="list-style-type: none"> <li>Check the USB medium connected to the PAL.</li> </ul> (Refer to page [5]-1.)
E-3097	IN/OUT PORT OVER CURRENT 1	<ul style="list-style-type: none"> <li>The connection of the electromagnetic valve connected from O3 of the output port to OR is short-circuited.</li> <li>Total output current of the electromagnetic valve is over rating value.</li> </ul>	<ul style="list-style-type: none"> <li>Check the wiring of the electromagnetic valve connected to output port O3 to OR.</li> <li>Exchange the electromagnetic valve.</li> <li>For example, shift the timing of each output and use it at the rated current value or less.</li> </ul>
E-3098	ADDITIONAL MOTOR OVER CURRENT 1	<ul style="list-style-type: none"> <li>Wiring to the P1 axis stepping motor is short circuited.</li> <li>The load on the Thread trimming mechanism is too large.</li> </ul>	<ul style="list-style-type: none"> <li>Check wiring of the P1 axis stepping motor.</li> <li>Check the sewing machine.</li> </ul>
E-3099	ADDITIONAL MOTOR OVER CURRENT 1	<ul style="list-style-type: none"> <li>Wiring to the P2 axis stepping motor is short circuited.</li> <li>The load on the digital tension mechanism is too large.</li> </ul>	<ul style="list-style-type: none"> <li>Check wiring of the P2 axis stepping motor.</li> <li>Check the sewing machine.</li> </ul>
E-3100	ADDITIONAL MOTOR ENCODER ERROR 1	<ul style="list-style-type: none"> <li>The P1 axis encoder connector has not been firmly inserted.</li> <li>The signal from the P1 axis encoder has been disconnected.</li> </ul>	<ul style="list-style-type: none"> <li>Check the insertion of the connector.</li> <li>Check the encoder signal by using IN/OUT setting mode.</li> </ul>
E-3101	ADDITIONAL MOTOR ENCODER ERROR 2	<ul style="list-style-type: none"> <li>The P2 axis encoder connector has not been firmly inserted.</li> <li>The signal from the P2 axis encoder has been disconnected.</li> </ul>	<ul style="list-style-type: none"> <li>Check the insertion of the connector.</li> <li>Check the encoder signal by using IN/OUT setting mode.</li> </ul>
E-3102	ADDITIONAL MOTOR HOME ERROR 1	<ul style="list-style-type: none"> <li>The connector of P1 axis home position sensor has not been firmly inserted.</li> <li>The signal from the P1 axis home position sensor has been disconnected.</li> </ul>	<ul style="list-style-type: none"> <li>Check the insertion of the connector.</li> <li>Check the P1 axis home position signal by using IN/OUT setting mode.</li> </ul>
E-3104	IN/OUT PORT POWER SUPPLY FAULT 1	<ul style="list-style-type: none"> <li>24 V power supply for electromagnetic valve is not supplied to the I/F board.</li> </ul>	<ul style="list-style-type: none"> <li>Check CON A connection.</li> <li>Exchange F2 fuse on I/F board.</li> </ul>
E-3105	IN/OUT PORT POWER SUPPLY FAULT 2	<ul style="list-style-type: none"> <li>24 V power supply for P1 axis or P2 axis is not supplied to the I/F board</li> </ul>	<ul style="list-style-type: none"> <li>Check CON A connection.</li> <li>Exchange F1 fuse on I/F board.</li> </ul>
E-3106	IN/OUT PORT POWER SUPPLY FAULT 3	<ul style="list-style-type: none"> <li>There is a trouble in the I/F board or 5V power supply is short-circuited.</li> </ul>	<ul style="list-style-type: none"> <li>Check the P1 axis or P2 axis encoder cable.</li> <li>Exchange the I/F board.</li> </ul>
E-3107	USB OVERCURRENT ERROR 3	<ul style="list-style-type: none"> <li>The USB medium connected to I/F board is faulty</li> <li>Non standard USB medium being used.</li> </ul>	<ul style="list-style-type: none"> <li>Check the USB medium connected to the I/F board.</li> </ul> (Refer to page [5]-1)

CODE	ERROR NAME	PROBABLE CAUSE	INSPECTION
E-3108	LESS AIR PRESSURE	<ul style="list-style-type: none"> <li>• Air pressure decrease detection input signal (ARS) was detected.</li> </ul>	<ul style="list-style-type: none"> <li>• Check the air pressure.</li> </ul>
E-3112	IN/OUT PORT OVER CURRENT 2	<ul style="list-style-type: none"> <li>• The electromagnetic valve connection connected to the output ports O1 and O2 is short-circuited.</li> <li>• Total output current of the electromagnetic valve is over rating value.</li> </ul>	<ul style="list-style-type: none"> <li>• Check the wiring of the electromagnetic valve connected to output port O1 and O2.</li> <li>• Exchange electromagnetic valve.</li> <li>• For example, shift the timing of each output and use it at the rated current value or less.</li> </ul>
E-3113	ADDITIONAL MOTOR A PHASE ADSORPTION ERROR 1	<ul style="list-style-type: none"> <li>• The Thread trimming mechanism (P1 axis stepping motor) is in contact with an obstacle.</li> </ul>	<ul style="list-style-type: none"> <li>• Check the thread trimming mechanism (P1 axis stepping motor).</li> </ul>
E-3114	ADDITIONAL MOTOR A PHASE ADSORPTION ERROR 2	<ul style="list-style-type: none"> <li>• The digital tension ( P2 axis stepping motor ) is in contact with the end of mechanism or an obstacle.</li> </ul>	<ul style="list-style-type: none"> <li>• Check the digital tension position (P2 axis stepping motor).</li> </ul>

## 2. [M-\*\*\*] Message code

CODE	MESSAGE	SUB-MESSAGE
M-001	NEEDLE IS NOT CORRECT POSITION	RETURN NEEDLE TO UP POSITION BY HAND OR NEEDLE UP ICON
M-002	NEEDLE THREAD WAS BROKEN	PLEASE THREAD THE NEEDLE
M-003	CLAMP IS UP	TURN ON THE FOOT SWITCH (BLACK FOOT SWITCH)
M-004	UP COUNTER SET VALUE UP	Please touch Enter Icon
M-005	DOWN COUNTER REACHED SET VALUE	Please touch Enter Icon
M-006	PATTERN DATA DOES NOT EXIST	READING OR TEACHING INPUT
M-007	CLAMP IS NOT AT HOME POSITION	PRESS HOME ICON
M-008	SERIAL DATA TRANSMITTING. (RS232C)	PLEASE WAIT FOR A WHILE
M-009	SERIAL DATA RECEIVING. (RS232C)	PLEASE WAIT FOR A WHILE
M-010	HALT SWITCH IS ON	PLEASE PUSH HALT SWITCH AGAIN
M-011	PLEASE RUN SEWING MACHINE	PLEASE ROTATE THE SEWING MACHINE BY THE WINDER OR SEWING
M-012	THE HALT SWITCH IS TURNED ON.	START SWITCH, +JOG, -JOG ICON IS INVALID. PLEASE TURN THE POWER OFF. * AFTER POWER LED IS TURNED OFF, TURN ON THE POWER.
M-013	KEY IS LOCKED	PLEASE UNLOCK THE KEY WHEN USING
M-014	CURRENT UP COUNTER VALUE IS PROTECTED	PLEASE TURN OFF PROHIBITION WHEN CORRECTING.
M-015	CURRENT DOWN COUNTER VALUE IS PROTECTED	PLEASE TURN OFF PROHIBITION WHEN CORRECTING.
M-016	CURRENT COUNTER VALUE HAS EXCEEDED THE SET VALUE	CURRENT VALUE MUST BE SMALLER THAN SETTING VALUE
M-017	STOPPING AT DOWN POSITION	NEEDLE BAR MOVES TO THE UP POSITION WITH NEEDLE UP ICON.
M-018	THE SETTING TABLE NUMBER IS CHANGED	THE SET TABLE NUMBER IS SET IN THIS SEWING DATA
M-019	SEWING DATA DOES NOT HAVE END CODE	PLEASE ADD END CODE
M-020	START INPUT SIGNAL IS TURNING ON	PLEASE TURN OFF START INPUT SIGNAL
M-021	CLAMP INPUT SIGNAL IS TURNING ON	PLEASE TURN OFF CLAMP INPUT SIGNAL
M-022	EXCITATION OF THE XY AXIS IS BEING RELEASED.	THE CLAMP FRAME CAN BE MOVED BY THE HAND.
M-023	NEEDLE IS NOT CORRECT POSITION	PLEASE MOVE NEEDLE TO UP POSITION BY MANUAL
M-024	CLAMP WILL MOVE TO THE SECOND HOME POSITION	ARE YOU SURE?      Yes: ENTER ICON      No: × ICON
M-025	CLAMP WAS DEVIATED FROM SEWING PATTERN	PRESS HOME ICON OR +JOG ICON
M-026	START SIGNAL AND JOG - ICON IS INEFFECTIVE	PRESS +JOG ICON
M-027	NEEDLE UP POSITION DETECTION WARNING	THE MAIN SHAFT WILL ROTATE TO DETECT UP POSITION. ATTENTION BEING CAUGHT IN THE MACHINE.
M-028	TERMINATION PROCESS COMPLETE	SEE YOU AGAIN!      * WAIT UNTIL THE LED OF THE CONTROL BOX IS COMPLETELY OFF, THEN POWER THE SWITCH ON AGAIN.
M-029	SETTING WILL NOT CHANGE	ARE YOU SURE?      Yes: ENTER ICON      No: × ICON

CODE	MESSAGE	SUB-MESSAGE
M-030	STITCH POSITION IS DEVIATED FROM THE SEWING PATTERN	PRESS +JOG OR -JOG ICON, THEN START SEWING.
M-031	INITIALIZES TO MANUFACUTRE SETTING	ARE YOU SURE?            Yes : ENTER ICON            No : × ICON
M-032	THIS IS NOT COMPLIANT CODE AT THIS SYSTEM VERSION.	-
M-033	IT IS SET TO [M2H] = HP2	PLEASE OPERATE IT AGAIN, AFTER IT SETS [M2H] IN ON OR OFF
M-034	STITCH NUMBER COUNTER 1 REACHED TO SETTING VALUE	CLR: STITCH NUMBER COUNTER 1 IS CLEARED. ENT: CLEARS MESSAGE
M-035	STITCH NUMBER COUNTER 2 REACHED TO SETTING VALUE	CLR: STITCH NUMBER COUNTER 2 IS CLEARED. ENT: CLEARS MESSAGE
M-036	THE PATTERN CHANGES	PRESS HOME ICON
M-037	INCORRECT RELEASE CODE	PLEASE INPUT AGAIN
M-038	MACHINE HEAD TILT WAS DETECTED	THE MACHINE HEAD IS TILTED POSITION. IF MACHINE HEAD IS NORMAL POSITION, CHECK THE MACHINE TILT SWICH AND CABLE.
M-039	BOARD TEMPERATURE WARNING	BOARD TEMPERATURE IS HIGH
M-040	STEP SEQUENCE PROGRAM ERROR	PLEASE CORRECT THE STEP SEQUENCE
M-041	STEP SEQUENCE DATA DOES NOT EXIST	PLEASE MAKE THE STEP SEQUENCE
M-042	S6 SIGNAL BEING DETECTED	PLEASE RELEASE THE S6 SIGNAL.
M-043	START PROHIBIT SIGNAL BEING DETECTED	PLEASE RELEASE THE START PROHIBIT INPUT SIGNAL.
M-044	COUNTER REACHED SET VALUE	PLEASE CLEAR THE COUNTER.
M-045	USER COUNTER 1 REACHED SET VALUE	PLEASE TOUCH ENTER ICON
M-046	USER COUNTER 2 REACHED SET VALUE	PLEASE TOUCH ENTER ICON
M-047	USER COUNTER 3 REACHED SET VALUE	PLEASE TOUCH ENTER ICON
M-048	USER COUNTER 4 REACHED SET VALUE	PLEASE TOUCH ENTER ICON
M-049	THERE ARE SUSPECT OF ABNORMAL STITCH	PLEASE CHECK STITCH
M-050	NOT IN THE HOME POSITION	PRESS HOME ICON
M-051	ILLEGAL SETTING	PLEASE INPUT A CORRECT VALUE
M-052	SET VALUE IS TOO LARGE	PLEASE INPUT THE VALUE WITHIN THE RANGE
M-053	SET VALUE IS TOO SMALL	PLEASE INPUT THE VALUE WITHIN THE RANGE
M-054	DATA DOES NOT EXIST	-
M-055	TOO MANY STITCHES	PLEASE DECREASE THE NUMBER OF STITCH
M-056	OUT OF DATA NUMBER (20000point)	PLEASE DECREASE THE INPUT POINT
M-057	OUT OF AREA LIMIT	PLEASE MAKE THE DATA IN THE AREA LIMIT
M-058	TOO SHORT STITCH LENGTH	PLEASE INPUT THE VALUE WITHIN THE RANGE
M-059	TOO LONG STITCH LENGTH	PLEASE INPUT THE VALUE WITHIN THE RANGE

CODE	MESSAGE	SUB-MESSAGE
M-060	SECOND HOME ALREADY EXISTS	ONLY ONE SECOND HOME POSITION POINT CAN BE INPUT
M-061	DATA WRITING TO MEMORY.	PLEASE WAIT FOR A WHILE
M-062	TOO LONG NON STITCH FEED	PLEASE CORRECT NON STITCH FEED DATA
M-063	NUMBER OF SKIP JOG IS OUT OF RANGE	PLEASE INPUT THE VALUE WITHIN THE RANGE
M-064	COULD NOT CALCULATE	PLEASE DECREASE THE INPUT POINT AND THE AMOUNT OF THE MOVEMENT AND INPUT AGAIN
M-065	NOT IN HOME POSITION	PRESS HOME ICON
M-066	DATA TYPE IS DIFFERENT	PLEASE CONFIRM DATA TYPE
M-067	CURVE DATA COULD NOT BE CREATED	PLEASE INPUT AGAIN REFERRING TO CURVE INPUT NOTES
M-068	PREPARING IMAGE DISPLAY.	PLEASE WAIT FOR A WHILE
M-069	THERE IS A SECOND HOME POSITION IN THE PATTERN DATA	PLEASE RETURN TO HOME POSITION
M-070	CURVE DATA CAN NOT BE CREATED	PLEASE REVIEW INPUT POINT
M-071	THERE IS NO DATA TO BE DELETED	-
M-072	TRIMMING CODE CAN NOT BE INPUTTED OR ADDED	PLEASE INPUT AND ADD THE TRIM AFTER SEW
M-073	CODE CAN NOT BE INPUTTED OR ADDED.	SAME CODE CAN NOT BE ADDED CONTINUOUSLY
M-074	THE SECOND HOME POSITION CAN NOT BE INPUTTED	PLEASE INPUT AND ADD THE 2HD AFTER FEED
M-075	THE END CODE CAN NOT BE INPUTTED	PLEASE INPUT AND ADD THE END AFTER FEED OR TRIM
M-076	CIRCLE OR ARC COULD NOT BE CREATED	PLEASE REVIEW INPUT POINT
M-077	THE OVERLAP BACK TACKING CANNOT BE SPECIFIED	THE OVERLAP BACK TAKING CAN BE USED ONLY FOR THE FIGURE WHERE CIRCLE, CURVE, AND BROKEN LINE SHUT.
M-078	DATA CAN NOT BE SAVED	PRESS HOME ICON. DATA WILL BE SAVED AFTER HOME POSITIONING
M-079	DATA CAN NOT BE SAVED	PRESS HOME ICON. DATA WILL BE SAVED AFTER HOME POSITIONING
M-080	TOO LONG STITCH	PLEASE CHANGE THE PATTERN DATA
M-081	THERE IS A SECOND HOME POSITION IN THE PATTERN DATA	PLEASE RETURN TO HOME POSITION
M-082	ILLEGAL SETTING	PLEASE INPUT A CORRECT VALUE
M-083	TRIM CODE CAN'T BE INPUTTED NOR ADDED	TRIM CODE CAN NOT BE ADDED JUST AFTER NEEDLE DOWN STOP CODE
M-084	DSTP CODE CAN NOT BE INPUTTED NOR ADDED	NEEDLE DOWN STOP CODE CAN NOT BE ADDED JUST BEFORE TRIM CODE
M-085	CLAMP POSITION HAS DEVIATED FROM INPUT COORDINATES	PLEASE RETURN TO HOME POSITION
M-086	CLAMP POSITION HAS DEVIATED FROM INPUT COORDINATES	PLEASE RETURN TO HOME POSITION
M-087	ZIGZAG DATA CAN NOT BE CREATED.	PLEASE CHANGE THE FEED AMOUNT OF ZIGZAG.
M-088	MULTIPLE, ZIGZAG, BACK TACKING CAN NOT BE SET	-
M-089	DATA CAN NOT BE CREATED.	THE MISTAKE IS FOUND IN G DATA.



CODE	MESSAGE	SUB-MESSAGE
M-090	CIRCLE OR ARC COULD NOT BE CREATED	PLEASE REVIEW THE INPUT POINT.
M-091	CLAMP POSITION HAS DEVIATED FROM INPUT COORDINATES.	EXCITATIONS OF THE MOTORS ARE RELEASED. MOVE THE CLAMP NEAR THE HOME POSITION BY HAND, THEN PRESS THE ENTER ICON.
M-092	CLAMP POSITION HAS DEVIATED FROM INPUT COORDINATES	EXCITATIONS OF THE MOTORS ARE RELEASED. MOVE THE CLAMP NEAR THE HOME POSITION BY HAND, THEN PRESS THE ENTER ICON.
M-093	DELETED MATERIAL THICKNESS VALUE	PLEASE SET ON THE PF HEIGHT SETTING [ZTHK] INSTEAD.
M-094	PRESSER FOOT IS DOWN	RAISE THE PRESSER FOOT (MATERIAL THICKNESS SETTING CAN BE DISPLAYED WHEN PRESSER FOOT IS UP POSITION.)
M-097	HEIGHT INPUT IS OVER	THE MATERIAL THICKNESS INPUT VALUE IS RANGE OVER.
M-098	HEIGHT CORRECTION IS OVER	THE MATERIAL THICKNESS CORRECTED VALUE IS RANGE OVER.
M-099	MATERIAL STEP IS OUT OF THICKNESS RANGE	PF HEIGHT IS OVER RANGE THE SETTING. PLEASE CHECK THE SEWING DATA OR THE [DFTH] CORD SETTING. -
M-100	MAKING DATA...	PLEASE WAIT FOR A WHILE
M-101	CALCULATING...	PLEASE WAIT FOR A WHILE
M-102	MAKE ARC DATA?	ARE YOU SURE? Yes: ENTER ICON No: × ICON
M-103	MAKE CIRCLE DATA?	ARE YOU SURE? Yes: ENTER ICON No: × ICON
M-104	MAKE CURVE DATA?	ARE YOU SURE? Yes: ENTER ICON No: × ICON
M-105	MAKE BROKEN LINE DATA?	ARE YOU SURE? Yes: ENTER ICON No: × ICON
M-106	MOVING TO END DATA	PLEASE WAIT FOR A WHILE
M-108	OUT OF DATA NUMBER(300point)	PLEASE DECREASE THE INPUT POINT
M-109	PRESSER FOOT IS DOWN	RAISE THE PRESSER FOOT
M-110	DATA TRANSMITTING...(USB)	PLEASE WAIT FOR A WHILE
M-111	DATA RECEIVING...(USB)	PLEASE WAIT FOR A WHILE
M-112	THE POSITION OF CLAMP AND THE XY AXIS ARE SHIFTED	PLEASE TURN THE POSER OFF
M-113	DIFFERENT MATERIAL THICKNESS IS DETECTED	PLEASE CHECK THE MATERIAL
M-114	THERE ARE SUSPECT OF ABNORMAL STITCH 2	PLEASE CHECK THE STITCH.
M-120	MOVING TO START POINT	PLEASE WAIT FOR A WHILE
M-121	MOVING TO STARTING POSITION	PLEASE WAIT FOR A WHILE
M-122	A SPECIFIED POSITION IS WRONG	PLEASE SPECIFY FOLLOWING STITCH FROM START POINT
M-123	THE AMOUNT OF THE MOVEMENT IS NOT INPUT	PLEASE INPUT AMOUNT OF MOVEMENT
M-124	A SPECIFIED POSITION IS WRONG	PLEASE SPECIFY SEWING DATA
M-125	A SPECIFIED POSITION IS WRONG	PLEASE SPECIFY SEWING AND FEED DATA
M-126	A SPECIFIED POSITION IS WRONG	PLEASE SPECIFY ONE STITCH FRONT IS SEW OR FEED DATA

CODE	MESSAGE	SUB-MESSAGE
M-127	A SPECIFIED POSITION IS WRONG	PLEASE SPECIFY PREVIOUS DATA FROM FINAL STITCH
M-128	A SPECIFIED POSITION IS WRONG	PLEASE SPECIFY CODE DATA
M-129	THE SPECIFIED CODE CANNOT BE DELETED.	THE TRIM CODE CANNOT BE DELETED WHEN THE FORWARD ARE SEW OR THE BACK ARE FEED.
M-130	SEWING DATA DOES NOT EXIST	THIS FUNCTION CANNOT BE USED
M-131	A SPECIFIED POSITION IS WRONG	PLEASE SPECIFY ONE STITCH REAR IS SEW OR FEED DATA
M-140	OFFSET DATA DOES NOT EXIST	-
M-141	MULTIPLE DATA DOES NOT EXIST	-
M-142	TOO SMALL REDUCTION RATIO	PLEASE DO A CORRECT SETTING
M-143	TOO LARGE ENLARGEMENT RATIO	PLEASE DO A CORRECT SETTING
M-144	THE POINT INPUT DATA CANNOT BE CONVERTED.	PLEASE SPECIFY SEWING DATA OTHER THAN THE POINT INPUT.
M-145	TACKING POSITION CAN'T BE CONVERTED	PLEASE SPECIFY SEWING DATA OTHER THAN THE POINT INPUT.
M-146	TACKING POSITION CAN'T BE CONVERTED	PLEASE SPECIFY SEWING DATA OTHER THAN THE POINT INPUT.
M-160	AREA LIMIT SETTING IS UNAVAILABLE	IT IS DANGEROUS WHEN USING BY THE AREA LIMIT RELEASE
M-161	HALT SWITCH IS ON	RELEASE HALT SWITCH. IF MESSAGE IS NOT CLEAR AFTER RELEASE HALT SWITCH, TURN THE POWER OFF AND CHECK HALT SWITCH & CABLE
M-162	ILLEGAL NUMBER WAS SET	PLEASE SETTING AGAIN
M-163	THE DATA IS BEING CONVERTED INTO A NEW VERSION.	PLEASE WAIT FOR A WHILE
M-164	NOT J-DATA	PLEASE SPECIFY THE "J DATA"
M-165	NOT J-DATA	PLEASE SPECIFY THE "J DATA"
M-180	Cassette jig sensor is not detected	-
M-188	USB MEDIUM IS NOT CONNECTED	PLEASE CONNECT USB MEDIUM
M-189	CAN NOT BE SAVED INTO USB MEDIUM	PATTERN DATA THAT WAS CREATED BY A FORMER SERIES CAN NOT BE SAVED
M-190	USB MEDIUM DEFECT	PLEASE CHANGE USB MEDIUM
M-191	INSUFFICIENT EMPTY AREA IN USB MEDIUM	PLEASE CHANGE USB MEDIUM OR DELETE FILES
M-192	SPECIFIED DATA DOES NOT EXIST IN THE USB MEDIUM	CHECK FILE NAME AND PATTERN DATA NUMBER
M-193	OPTIMIZING INTERNAL MEMORY	PLEASE WAIT FOR A WHILE
M-194	CLEAR CONTENT OF THE SHORT CUT BUTTON	ARE YOU SURE? Yes: ENTER ICON(PATTERN DATA WILL NOT BE ERASED) No: × ICON
M-195	WRITING SEWING DATA INTO USB MEDIUM	PLEASE WAIT FOR A WHILE
M-196	DELETING SEWING DATA IN USB MEDIUM	PLEASE WAIT FOR A WHILE
M-197	READING SEWING DATA FROM USB MEDIUM	PLEASE WAIT FOR A WHILE

CODE	MESSAGE	SUB-MESSAGE
M-198	OVERWRITES DATA IN USB MEDIUM	ARE YOU SURE?    Yes: ENTER ICON    No: × ICON
M-199	DELETES SEWING DATA IN USB MEDIUM	ARE YOU SURE?    Yes: ENTER ICON    No: × ICON
M-201	CORRESPONDING DATA DOES NOT EXIST IN USB MEDIUM	PLEASE CHANGE USB MEDIUM
M-202	READING FILE INFORMATION OF THE USB MEDIUM	PLEASE WAIT FOR A WHILE
M-203	USB MEDIUM IS CONNECTED	PLEASE DETACH USB MEDIUM
M-204	READING COMPLETE	PLEASE DETACH USB MEDIUM
M-205	WRITING COMPLETE	PLEASE DETACH USB MEDIUM
M-206	TERMINATE USB MEDIUM PROCESSING	PLEASE DETACH USB MEDIUM
M-207	USB MEDIUM OVERCURRENT	PLEASE CHANGE USB MEDIUM
M-208	USB WAS DISCONNECTED	SWITCH TO INTERNAL MEMORY
M-209	INTERNAL MEMORY DEFECT	INTERNAL MEMORY WILL BE FORMATTED. PRESS ENTER ICON
M-210	SAVED FILE NUMBER IS OVER LIMIT	PLEASE ERASE UNUSED DATA
M-211	SPECIFIED SEWING DATA DOES NOT EXIST IN THE MEMORY	CHECK FILE NAME AND PATTERN DATA NUMBER
M-212	MEMORY FORMATTING...	PLEASE WAIT FOR A WHILE
M-213	FORMATTING INTERNAL MEMORY...	-
M-214	THERE IS NO NUMBER THAT HAS BECOME EMPTY IN MEMORY	PLEASE DELETE UNNECESSARY DATA
M-215	WRITING SEWING DATA INTO THE INTERNAL MEMORY...	PLEASE WAIT FOR A WHILE
M-216	DELETING SEWING DATA IN THE INTERNAL MEMORY...	PLEASE WAIT FOR A WHILE
M-217	READING SEWING DATA FROM THE INTERNAL MEMORY...	PLEASE WAIT FOR A WHILE
M-218	DELETES SEWING DATA IN THE INTERNAL MEMORY	ARE YOU SURE?    Yes: ENTER ICON    No: × ICON
M-219	OVERWRITES SEWING DATA IN THE INTERNAL MEMORY	ARE YOU SURE?    Yes: ENTER ICON    No: × ICON
M-220	INSUFFICIENT EMPTY AREA IN THE INTERNAL MEMORY	PLEASE ERASE UNUSED PATTERN DATA, AND OPTIMIZE AN INTERNAL MEMORY.
M-221	INTERNAL MEMORY IS DAMAGED	INTERNAL MEMORY IS DEFECTIVE. PLEASE REINSTALL SYSTEM
M-222	PATTERN DATA CAN NOT BE DELETED	CURRENT PATTERN DATA CAN NOT BE ERASED
M-223	FORMATS INTERNAL MEMORY	ARE YOU SURE?    Yes: ENTER ICON    No: × ICON
M-224	OPTIMIZES INTERNAL MEMORY	ARE YOU SURE?    Yes: ENTER ICON (SEWING DATA WILL NOT BE ERASED) No: × ICON
M-226	COMBINATION DATA CAN NOT BE CREATED	PATTERN DATA WHICH CONTAINS SECOND HOME POSITION CAN NOT BE USED FOR COMBINATION.
M-227	CAN NOT CHANGE PATTERN DATA NUMBER	CAN NOT CHANGE TO PATTERN DATA NUMBER WHICH IS USING.
M-228	OUT OF AREA LIMIT	PLEASE CHANGE PATTERN DATA

CODE	MESSAGE	SUB-MESSAGE
M-229	WRONG PATTERN DATA WAS SET	PLEASE CHANGE PATTERN DATA
M-230	CAN NOT READ	PRESS HOME ICON
M-231	CAN NOT WRITE	PRESS HOME ICON
M-232	TOO MANY STITCHES	PLEASE CHANGE PATTERN DATA
M-233	CHECKING SUM...	PLEASE WAIT FOR A WHILE
M-234	ILLEGAL FILE NAME	PLEASE INPUT THE FILE NAME BY 8 CHARACTERS OR LESS
M-235	ILLEGAL PATTERN NUMBER	PLEASE INPUT CORRECT SEWING DATA NUMBER.
M-236	THE LIMIT OF THE SEWING AREA IS EXCEEDED	IT IS DANGEROUS. PLEASE CHANGE THE SEWING DATA
M-237	CHANGE PATTERN DATA TO G-DATA	ARE YOU SURE?      Yes: ENTER ICON No: × ICON (BACK TO SELECTION SCREEN)
M-238	INCORRECT PASSWORD	PLEASE INPUT AGAIN
M-240	CAN NOT READ COMBINATION PATTERN	PLEASE CLEAR COMBINATION PATTERN (PRESS CLR ICON)
M-241	INPUT IS NOT RIGHT	PLEASE SET THE ID IN 1-4 CHARACTERS
M-244	USB INSTALL FILE ERROR	
M-246	NEEDLE IS NOT CORRECT POSITION	PLEASE ADJUST UP POSITION SENSOR OR [U8] SETTING
M-250	ADDRESS SETTING IS COMPLETED	-
M-251	THERE IS NO CHANGE THE ADDRESS SETTING	-
M-252	IT IS FAILED THE ADDRESS SETTING	PLEASE INPUT AGAIN
M-253	ADDRESS SETTING NOW...	PLEASE WAIT FOR A WHILE
M-247	TRIMMING OUTPUT WAS CANCELED	PLEASE ADJUST TRIMMING START TIME/ANGLE [TRS]
M-248	TENSION RELEASE OUTPUT WAS CANCELED	PLEASE ADJUST TENSION RELEASE START TIME/ANGLE [LRS]
M-249	LANGUAGE INFORMATION IS GETTING NOW ...	PLEASE WAIT FOR A WHILE
M-255	DO NOT SAVE END CODE	-
M-256	PLEASE CLEAN UP	-
M-257	PLEASE CHANGE THE BELT	-
M-258	PLEASE WORK ON MAINTENANCE	-
M-259	PLEASE CHANGE BOBBIN	-
M-260	BOBBIN BEING CHANGED	DO NOT TOUCH
M-261	THERE IS NO BOBBIN	PLEASE SET BOBBIN
M-262	TROUBLE 1 OCCURRED	ATTENTION
M-263	TROUBLE 2 OCCURRED	ATTENTION
M-264	TROUBLE 3 OCCURRED	ATTENTION

CODE	MESSAGE	SUB-MESSAGE
M-265	TROUBLE 4 OCCURRED	ATTENTION
M-266	TROUBLE 5 OCCURRED	ATTENTION
M-274	CAN NOT USE COMBINATIONAL FUNCTION.	DISABLE THE FUNCTION OF PATTERN SELECTION BY USING OF EXTERNAL SIGNAL
M-275	CAN NOT READ, BECAUSE THE COMBINATION IS BEING USED	PLEASE ENTER THE COMBINATION MODE ON FUNCTION MODE AND PRESS THE CLR ICON TO DEACTIVATE THE COMBINATION FUNCTION
M-276	INCORRECT NUMBER OF PATTERN DATA	CAN NOT CHANGE TO FORMER SERIESE NUMBER OF PATTERN DATA
M-277	COPIES REGISTERED SEWING DATA	ARE YOU SURE?    Yes: ENTER ICON    No: × ICON *IF THERE IS SAME NUMBER IN THE MEMORY,DATA IS OVERWRITTEN
M-278	DELETES COMBINATIONAL SEWING DATA	ARE YOU SURE?    Yes: ENTER ICON    No: × ICON
M-279	DELETES DOCKING SEWING DATA	ARE YOU SURE?    Yes: ENTER ICON    No: × ICON
M-280	COPYING SEWING DATA FROM USB MEDIUM TO THE MEMORY...	PLEASE WAIT FOR A WHILE
M-281	COPYING SEWING DATA FROM THE MEMORY TO USB MEDIUM...	PLEASE WAIT FOR A WHILE
M-282	INCORRECT PASSWORD	PLEASE INPUT AGAIN
M-283	COPY FAILED	SOME SEWING DATA WERE NOT COPIED COMPLETELY. PLEASE CHECK THAT COPIED SEWING DATA.
M-284	USB MEDIUM IS WRITE PROTECTED	PLEASE UNLOCK WRITE PROTECTION OF USB MEDIUM
M-287	ILLEGAL SETTING	PLEASE SELECT SETTING FILE THAT IS CREATED ON SAME SEWING MACHINE MODEL
M-288	THERE IS NO DIFFERENCE	-
M-289	PATTERN DATA DOES NOT EXIST	-
M-290	READING COMPLETE	PLEASE TURN OFF THE POWER. PLEASE RE-TURN ON THE POWER AFTER POWER LED (GREEN) OF THE CONTROL BOX IS TURNED OFF.
M-291	READING SETTING FILE...	PLEASE WAIT FOR A WHILE
M-292	READING STEP FILE...	PLEASE WAIT FOR A WHILE
M-293	READING SYSTEM FILE...	PLEASE WAIT FOR A WHILE
M-294	CURRENT USED TABLE IS OVERWRITTEN	ARE YOU SURE?    Yes: ENTER ICON    No: × ICON
M-295	COPIES SPECIFIED PATTERN DATA	ARE YOU SURE?    Yes: ENTER ICON    No: × ICON *IF THERE IS SAME NUMBER IN THE MEMORY,DATA IS OVERWRITTEN
M-296	COPIES ALL PATTERN DATA	ARE YOU SURE?    Yes: ENTER ICON    No: × ICON *IF THERE IS SAME NUMBER IN THE MEMORY,DATA IS OVERWRITTEN
M-297	OVERWRITES COMBINATION DATA	ARE YOU SURE?    Yes: ENTER ICON    No: × ICON
M-298	CLEARs COMBINATION FORM	ARE YOU SURE?    Yes: ENTER ICON    No: × ICON
M-299	MILLING CUTTER IS IN LOWER POSITION	PLEASE RAISE MILL, THEN TOUCH HOME ICON

DE	MESSAGE	SUB-MESSAGE
M-300	SETTING HAS BEEN CHANGED	PLEASE TURN OFF THE POWER. PLEASE RE-TURN ON THE POWER AFTER POWER LED (GREEN) OF THE CONTROL BOX IS TURNED OFF.
M-301	MODEL SETTING IS CONFIRMED	ARE YOU SURE?      Yes : ENTER ICON      No : × ICON
M-302	WRITING MODEL SETTING	PLEASE INPUT AGAIN
M-303	UPGRADE COMPLETE	PLEASE RE-TURN ON THE POWER AFTER POWER LED (GREEN) OF THE CONTROL BOX IS TURNED OFF.
M-304	EXECUTES UPGRADE PROCESSING	ARE YOU SURE?      Yes : ENTER ICON      No : × ICON
M-305	INITIALIZES SET VALUE	ARE YOU SURE?      Yes: ENTER ICON (ALL SETTINGS ARE INITIALIZED) No: × ICON
M-306	USER FOLDER DOES NOT EXIST IN THE USB MEDIUM	USER FOLDER CREATION OK?      Yes: ENTER ICON      No: × ICON
M-307	USER FOLDER DOES NOT EXIST IN THE USB MEDIUM	PLEASE CREATE USER FOLDER ( USER_SYSTEM)
M-308	VERSION IS THE SAME	UPGRADE WAS NOT DONE.
M-309	INITIALIZED SELECTED ITEM	ARE YOU SURE?      Yes: ENTER ICON (SELECTED SETTINGS ARE INITIALIZED) No: X ICON
M-310	MAKER INSTALLATION COMPLETE	PLEASE RE-TURN ON THE POWER AFTER POWER LED (GREEN) OF THE CONTROL BOX IS TURNED OFF.
M-311	INSTALLATION COMPLETE	PLEASE RE-TURN ON THE POWER AFTER POWER LED (GREEN) OF THE CONTROL BOX IS TURNED OFF.
M-312	NO SELECTED ITEM	INITIALIZATION IS NOT EXECUTED.
M-313	RECEIVE TIME OUT OF USB COMMUNICATION	-
M-314	LANGUAGE SETTING IS CONFIRMED	ARE YOU SURE?      Yes: ENTER ICON      No: × ICON
M-315	READ THE DATA	IT WILL BECOME CHANGING THE SETTING, PATTERN AND STEP SEQUENCE DATA Yes: ENTER ICON      No: × ICON
M-319	USB CMMUNICATION WAS TIME OUT	PLEASE DETACH USB MEDIUM.
M-328	TEST DRIVE RUNNING	BE CAREFUL







**mitsubishi electric corporation**

Printed in Japan